







Hardware for pivoting and lateral sliding in of wooden doors up to 25 kg (55 lbs.). Uniform, flush front design with even gap pattern. Pull version with handle and integrated soft closing mechanism.

Product highlights

-  **Productivity** Easy installation thanks to high degree of pre-assembly with intuitive adjustment
-  **Comfort** Ergonomic movement support for even, smooth movement
-  **Aesthetics** Allows constructions with and without handle – the technology remains invisible

Technical specifications

-  6–25 kg (13 to 55 lbs.)
-  1200–2200 mm (3' 11 1/4" to 7' 2 5/8")
-  440–750 mm (1' 5 5/16" to 2' 5 17/32")
-  18–26 mm (23/32" to 1 1/32")

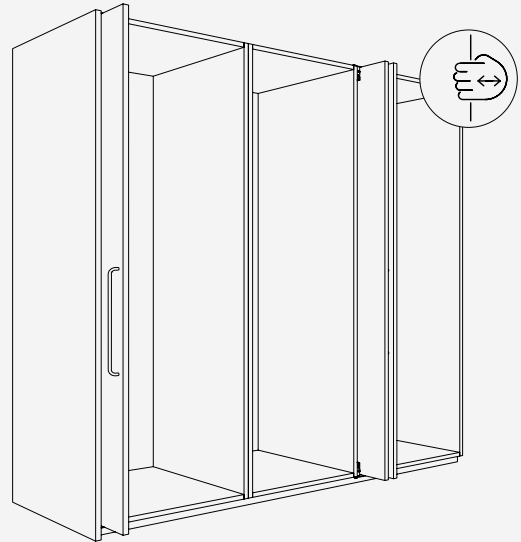

Installation examples

Door striking against the top and bottom cabinet sections

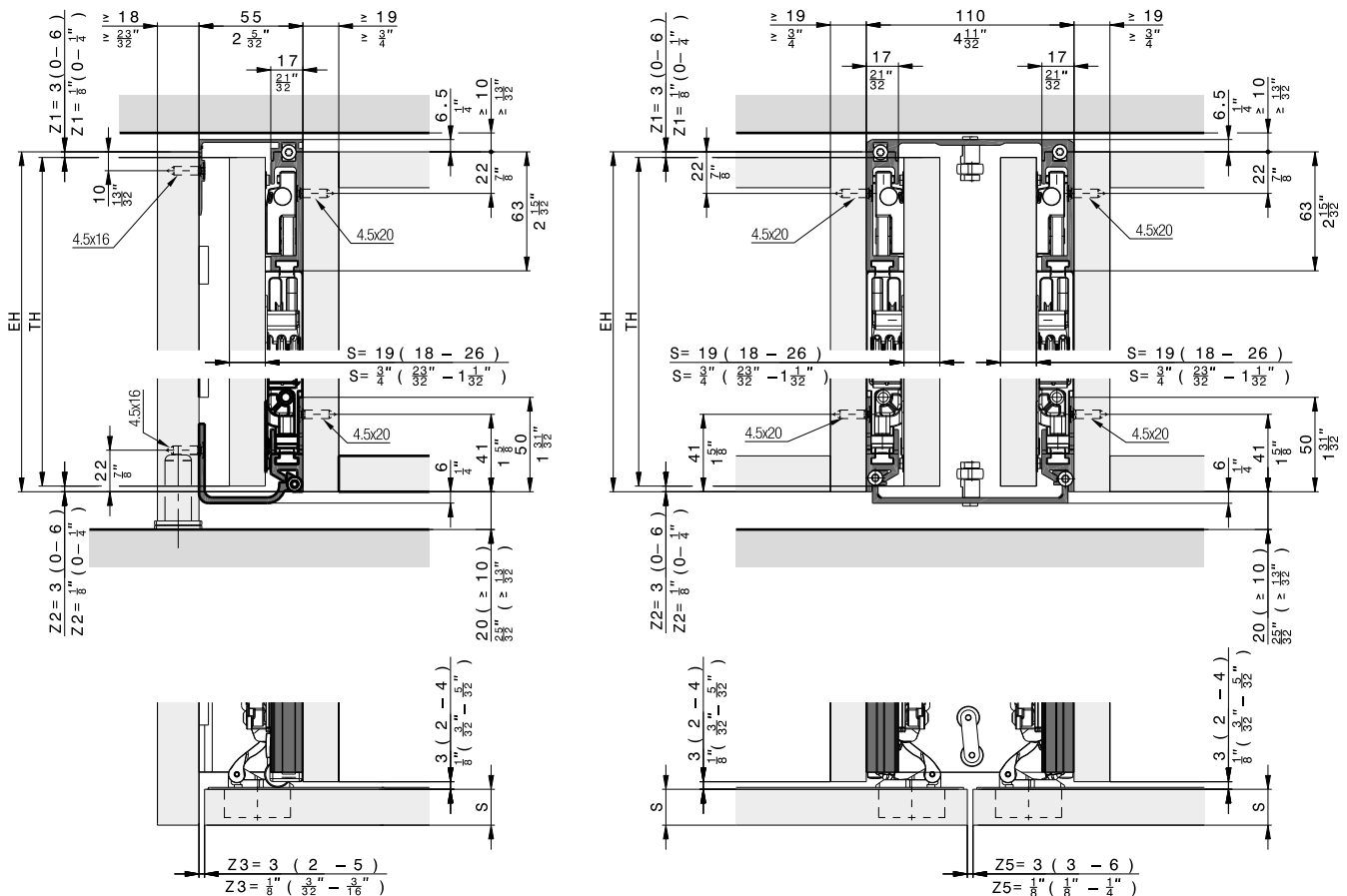

Components required for one cabinet

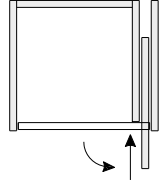
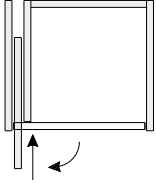

Hawa Concepta III 25 Pull, left

	No.
Hawa Concepta III 25, basic set left, door height 1200–2200 mm (3' 11 1/4" to 7' 2 5/8")	30994
Hawa Concepta III 25/35, Pull slide-in set, left	31000
Upright profile L= 1974 mm (6' 5 23/32"), for door height 1200–2200 mm (3' 11 1/4" to 7' 2 5/8"), aluminum, anodized	30778

Hawa Concepta III 25 Pull, right

	No.
Hawa Concepta III 25, basic set right, door height 1200–2200 mm (3' 11 1/4" to 7' 2 5/8")	30995
Hawa Concepta III 25/35, Pull slide-in set, right	31001
Upright profile L= 1974 mm (6' 5 23/32"), for door height 1200–2200 mm (3' 11 1/4" to 7' 2 5/8"), aluminum, anodized	30778

Weight and door size ratio calculations

The maximum weight must be adapted depending on the door size ratio.

DE Türbreite / FR Largeur de porte / EN Door width / IT Larghezza anta / ES Ancho de puerta

	440	500	550	600	650	700	750
2200	25	25	25	25	25	25	24
2150	25	25	25	25	25	25	23
2100	25	25	25	25	25	24	23
2050	25	25	25	25	25	24	22
2000	25	25	25	25	25	23	21
1950	25	25	25	25	24	22	21
1900	25	25	25	25	23	21	20
1850	25	25	25	24	22	21	19
1800	25	25	25	23	21	20	19
1750	25	25	25	22	21	19	18
1700	25	25	24	22	20	19	17
1650	25	25	23	21	19	18	17
1600	25	24	22	20	18	17	16
1550	25	23	21	19	18	16	15
1500	24	22	20	18	17	16	15
1450	23	21	19	17	16	15	14
1400	22	20	18	17	15	14	13
1350	21	19	17	16	15	14	13
1300	20	18	16	15	14	13	12
1250	19	17	15	14	13	12	11
1200	18	16	15	13	12	11	11

	1' 5 5/16"	1' 7 11/16"	1' 9 21/32"	1' 11 5/8"	2' 1 19/32"	2' 3 9/16"	2' 5 17/32"
7' 2 5/8"	55	55	55	55	55	55	53
7' 0 21/32"	55	55	55	55	55	55	51
6' 10 11/16"	55	55	55	55	55	53	51
6' 8 23/32"	55	55	55	55	55	53	49
6' 6 3/4"	55	55	55	55	55	51	46
6' 4 25/32"	55	55	55	55	53	49	46
6' 2 13/16"	55	55	55	55	51	46	44
6' 0 27/32"	55	55	55	53	49	46	42
5' 10 7/8"	55	55	55	51	46	44	42
5' 8 29/32"	55	55	55	49	46	42	40
5' 6 15/16"	55	55	53	49	44	42	37
5' 4 31/32"	55	55	51	46	42	40	37
5' 3"	55	53	49	44	40	37	35
5' 1 1/32"	55	51	46	42	40	35	33
4' 11 1/16"	53	49	44	40	37	35	33
4' 9 3/32"	51	46	42	37	35	33	31
4' 7 1/8"	49	44	40	37	33	31	29
4' 5 5/32"	46	42	37	35	33	31	29
4' 3 3/16"	44	40	35	33	31	29	26
4' 1 7/32"	42	37	33	31	29	26	24
3' 11 1/4"	40	35	33	29	26	24	24

DE Türgewicht in kg / FR Poids de porte en kg / EN Door weight in kg / IT Peso anta in kg / ES Peso de puerta en kg











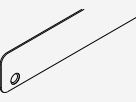

DE Türgewicht in lbs. / FR Poids de porte en lbs. / EN Door weight in lbs. / IT Peso anta in lbs. / ES Peso de puerta en lbs.

Hawa Configurator

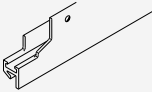
List of individual parts, which are included in the sets:



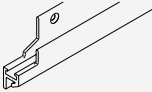

Set for 1 pivot /slide-in door up to 25 kg (55 lbs.)

	No.
Hawa Concepta III 25, basic set left, door height 1200–2200 mm (3' 11 1/4" to 7' 2 5/8")	30994
Hawa Concepta III 25, basic set right, door height 1200–2200 mm (3' 11 1/4" to 7' 2 5/8")	30995

	30994	30995	No.
Set consisting of:			
 Slot nuts for hinge attachment, plastic, black	3	3	30686
 Mounting plate for hinge with height adjustment, steel, nickel-plated	1	1	30738
 Concealed hinge, with soft closing mechanism and closing spring, steel, nickel plated	3	3	31070
 Set for concealed hinges, 8 screws 4x16 mm (5/32"x5/8"), 3 door stop buffers	1	1	30811
 Profile for magnetic guide, with double-sided adhesive tape, steel, black, L=730 mm (2' 4 3/4")	2	2	30983
 Euro screw, 6x13 mm (1/4"x1/2"), steel, black, set of 6 pieces	1	1	30986
 Bottom guide track left, aluminum, anodized, L= 838 mm (2' 9")	1		30805
 Top running track left, aluminum, anodized, L= 838 mm (2' 9")	1		31059
 Countersunk head screw, 4.5x20 mm (5/32"x25/32"), steel, zinc-plated, set of 16 pieces	1	1	30810
 Set of adjusting tools	1	1	31047
 Bottom guide track right, aluminum, anodized, L= 838 mm (2' 9")		1	30806
 Top running track right, aluminum, anodized, L= 838 mm (2' 9")		1	31060

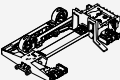
Suitable slide-in set

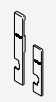
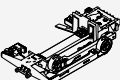
	No.
Hawa Concepta III 25/35, Pull slide-in set, left	31000
Hawa Concepta III 25/35, Pull slide-in set, right	31001

	31000	31001	No.
Set consisting of:			
 Hawa Concepta III 25/35 Pull slide-in unit, left	1		31040
 End stop bracket Pull, steel zinc-plated	1	1	31414
 Soft closing mechanism with end stop	1	1	31221
 Hawa Concepta III Pull set of cover caps, for left-hand stop, plastic, black	1		30964
 Hawa Concepta III 25/35 Pull slide-in unit, right		1	31041
 Hawa Concepta III Pull set of cover caps, for right-hand stop, plastic, black		1	30965

Cabinet connecting parts

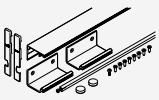
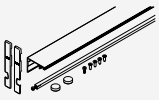
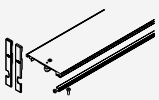
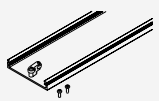
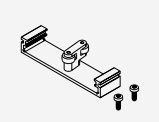
		mm (inch)	No.
	Connector set 55 mm (2 5/32"), for exterior connection to cabinet	560 (1' 10 1/16")	31005
	Connector top 55 mm (2 5/32"), for exterior connection to cabinet	560 (1' 10 1/16")	31430
	Connector top 110 mm (4 11/32"), for two pivot/slide-in doors	500 (1' 7 11/16")	31006
	Connector bottom 110 mm (4 11/32"), for two pivot/slide-in doors	500 (1' 7 11/16")	31246
	Connector bottom 110 mm (4 11/32"), for two pivot/slide-in doors (for installation in front of fixed plinth)	26 (1 1/32")	31007

Guides

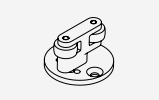
		No.
	Guide for two inset pivot sliding doors, aluminum	25680

Accessories

		No.
	Support for Halemeier automatic shut-off device Matching push button item 36 979 01 for Halemeier automatic shut-off device (Safety Box)	31020

Straightening fitting

→ Details under accessories from page 265

Aluminum rew

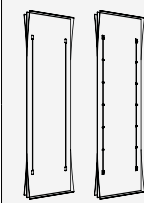
		No.
	Straightening fitting for doors 1715–2275 mm (3' 11 27/32" to 5' 9 7/8"), aluminum	056.3192.079
	Straightening fitting for doors 1215–1775 mm (3' 11 27/32" to 5' 9 7/8"), aluminum	056.3192.073

Aluminum anodized

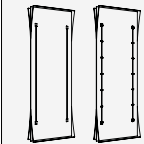
		Nr.
	Straightening fitting for doors 1715–2275 mm (5' 7 17/32" to 7' 5 9/16"), aluminum, anodized, can be shortened for doors 1215–1715 mm (3' 11 27/32" to 5' 7 17/32")	056.3192.080

Aluminum black anodized

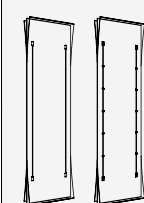
		No.
	Straightening fitting for doors 1715–2275 mm (5' 7 15/32" to 7' 5 9/16"), aluminum, black anodized	056.3192.081
	Straightening fitting for doors 1215–1775 mm (3' 11 27/32" to 5' 9 7/8"), aluminum, black anodized	056.3192.076

Straightening fitting

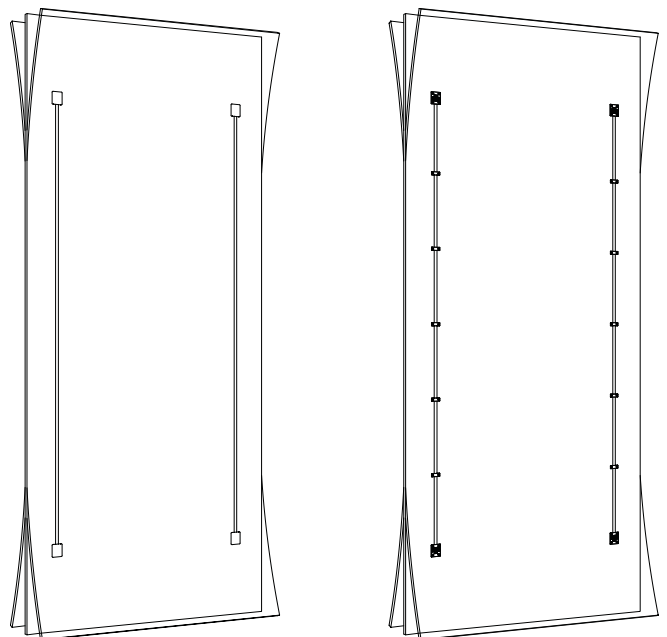

Further installation examples
Composed cabinet

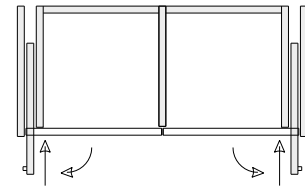
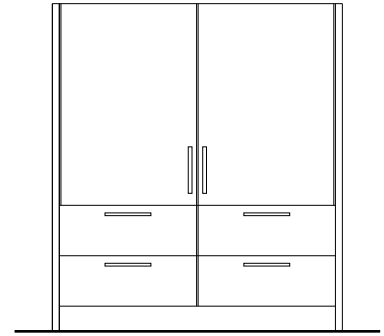
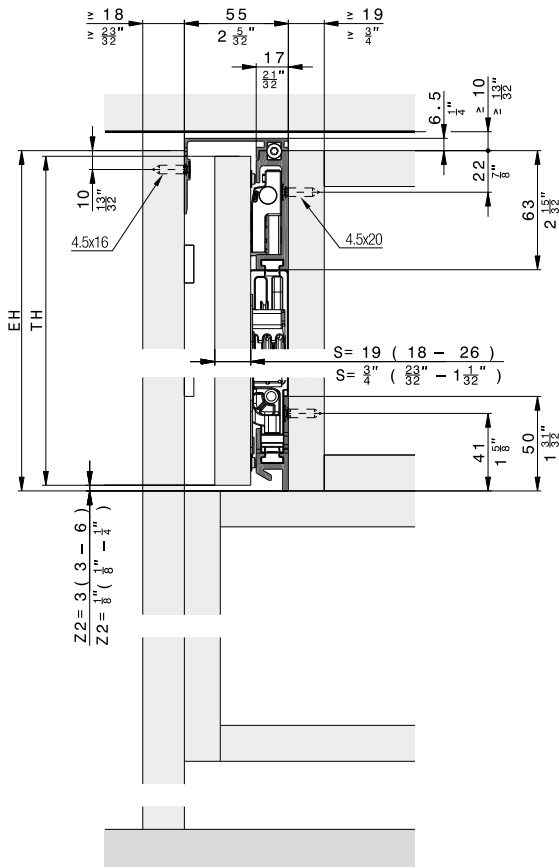

Cabinet without base panel

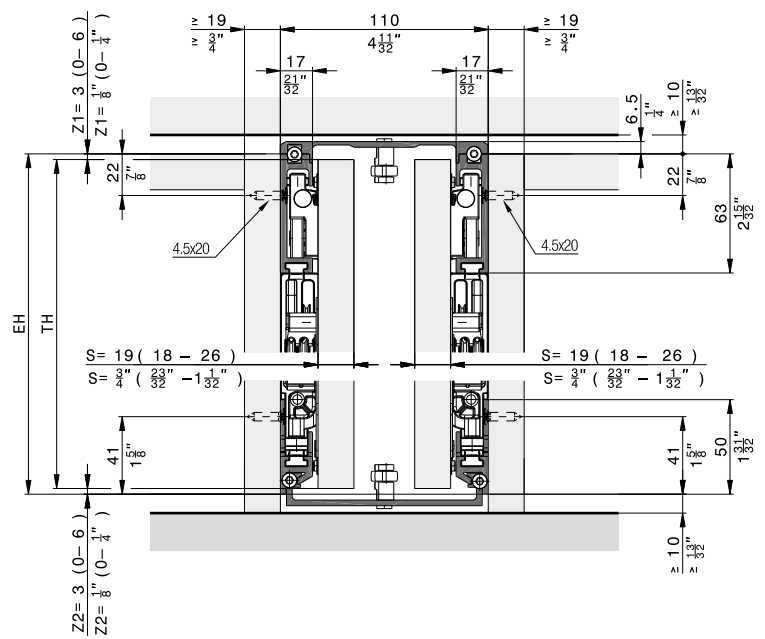
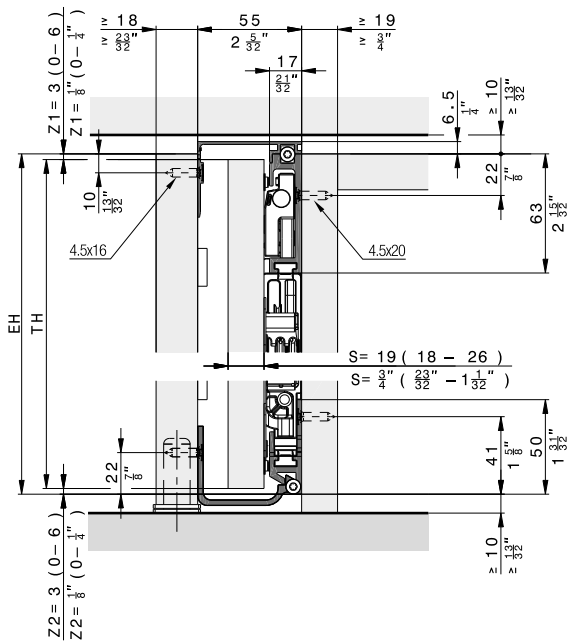

Inlaid doors

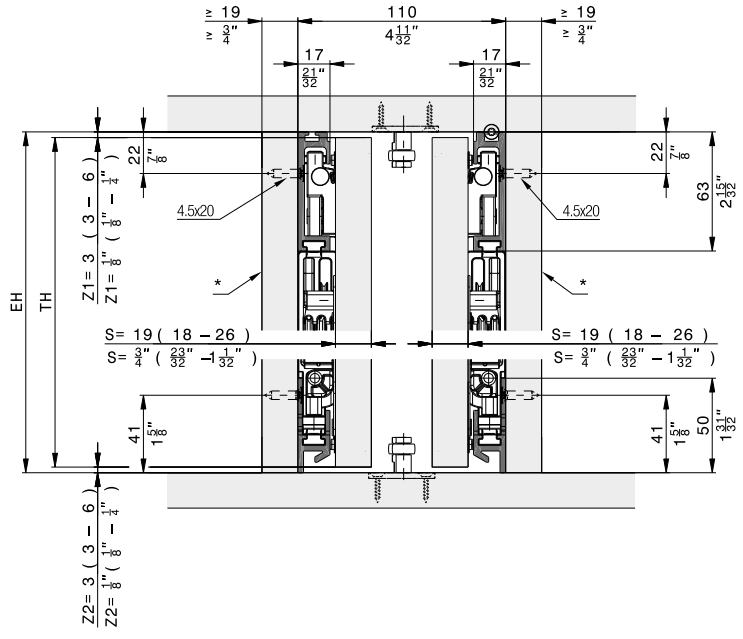
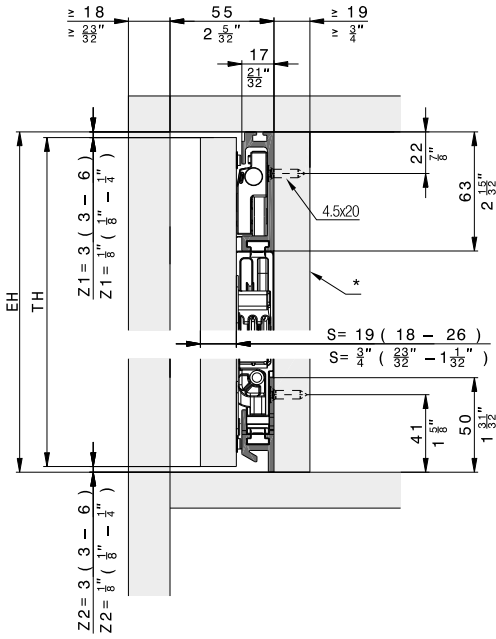

* removable

Floor-to-ceiling doors

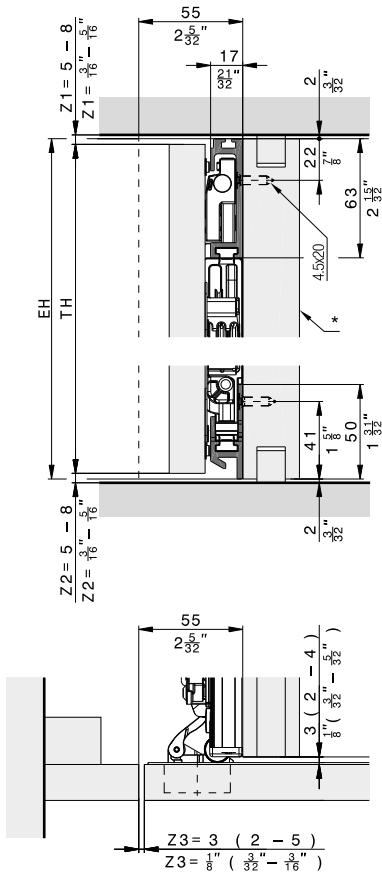

* removable

Hardware depth calculation

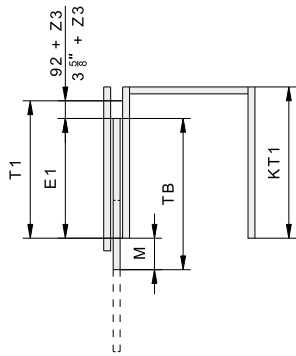

	mm	Inch
T1	≥ 414	≥ 1' 4 ⁵ / ₁₆ ''

	mm	Inch
T1	TB + 92 + Z3 - M	TB + 3 ⁵ / ₈ '' + Z3 - M
E1	TB - M	TB - M
M	≥ S + 3 ≤ TB - 320	≥ S + ⁵ / ₈ '' ≤ TB - 1 ¹⁹ / ₃₂ ''

Door flush with outer face

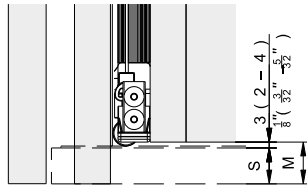

Protruding door

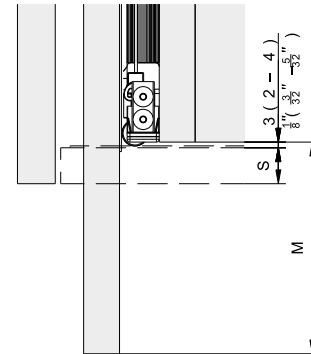

Instructions

Videos

Accessories

– Straightening fitting from page 265

Planning/execution

Configure with just a few clicks at www.hawa.com/configurator

Further information about the product can be found on www.hawa.com.