

Manual No. 14

Door and window hardware

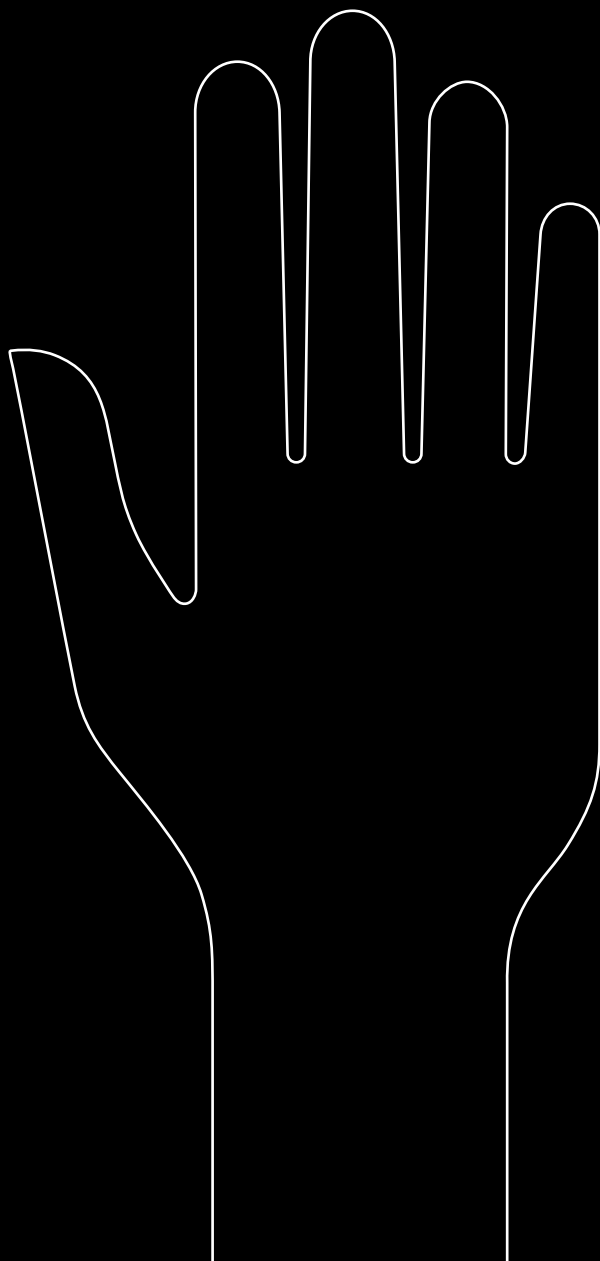

It's in your hands.

 **FSB 140**

Quality in hand.
Made in Brakel, Germany.
Since 1881.

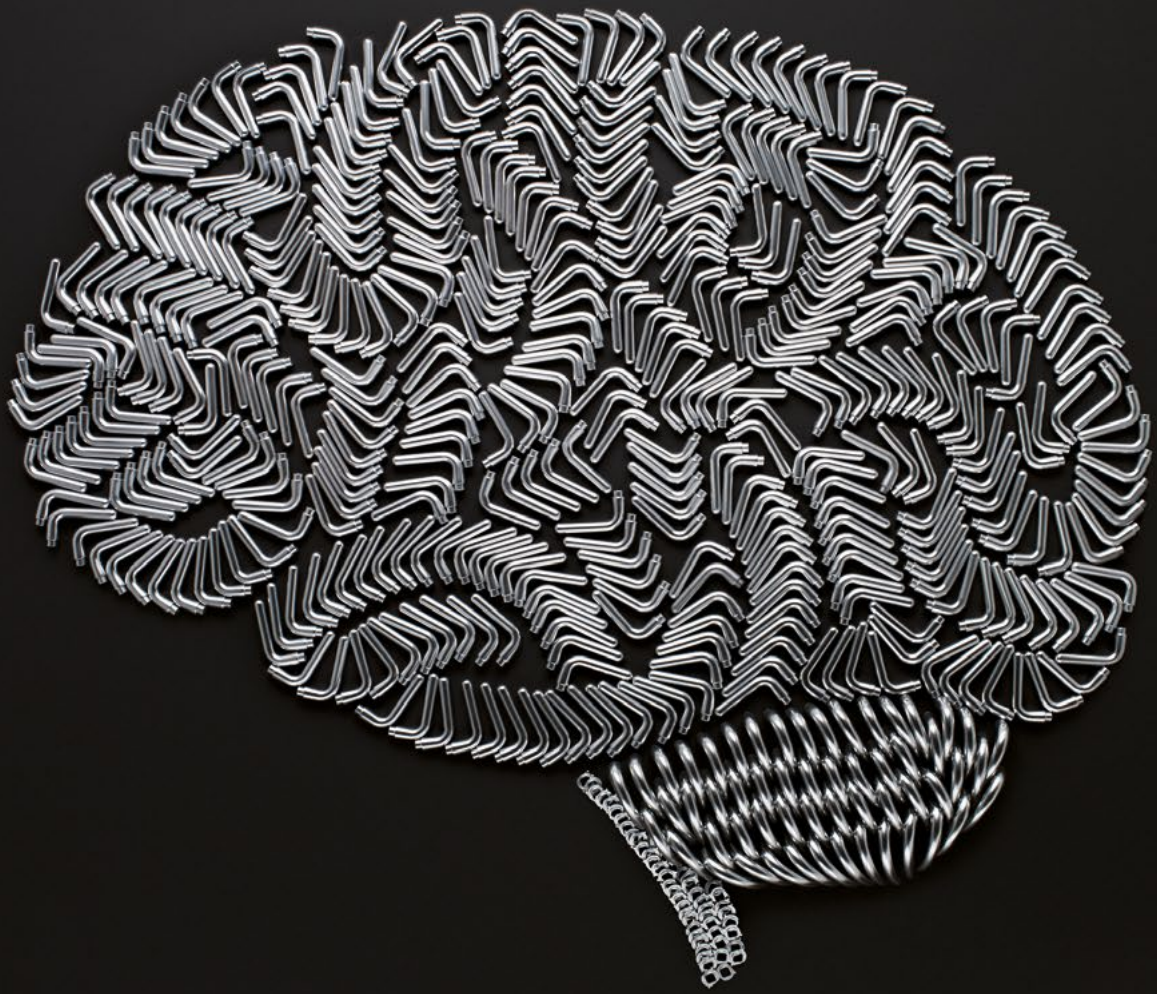





Good architecture is not just about great ideas; it is also the sum total of perfect detail. You will find our products all over the world – indeed, wherever people come into contact with architecture and truly ‘grasp’ it.

Photo: Jochen Stüber
Project: Schanzenlofts, Hamburg
Architectural firm: Giorgio Gullotta Architekten



| | |
|----|-------------------------|
| 6 | Made in Brakel, Germany |
| 8 | The FSB DNA |
| 10 | FSB Handmade |
| 12 | FSB Care |
| 14 | Materials and finishes |

Made in Brakel, Germany

It's in your hands.



FSB 1021 door handle

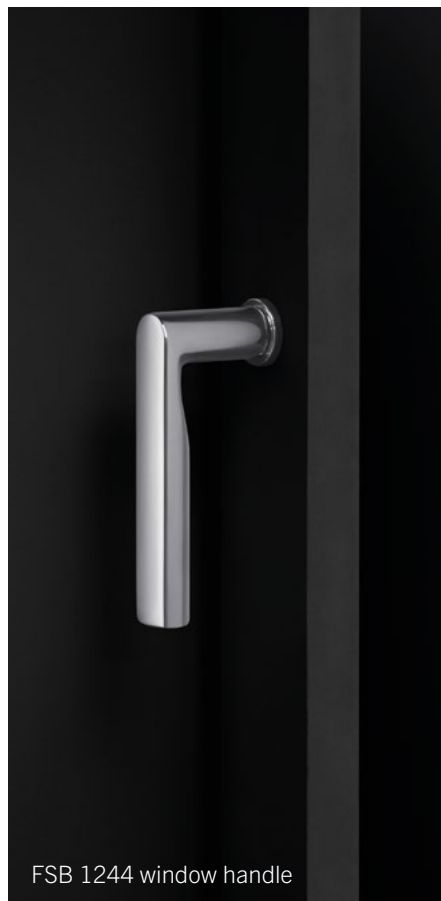

FSB 1244 window handle

When technology and design go hand in hand

FSB is a synonym the world over for visually and functionally compelling hardware solutions for doors and windows and barrier-free sanitary fit-outs. Our products are as functionally reliable as they are long-lasting and give you the peace of mind of knowing you made the right choice. We collaborate with renowned architects and designers from all over the world to deliver well-conceived, top-quality solutions, made in Brakel in eastern Westphalia and coordinated to suit all fitting scenarios. FSB caters to all aspects of handle culture in built space from a single source.

A symbiosis of certainty and sustainability – made in Germany

‘Sustainability’ signifies a product philosophy consistently geared towards the utmost in quality that is thus sustainable in the best sense of the word. Engineering and design are always rated as a function of the length of use of buildings. With FSB you are making a safe long-term and cost-effective investment. Our products are about creating buildings that continue to function properly over long periods and meet the specific needs of their users.

FSB is a member of the German Sustainable Building Council (DGNB) and a leader in ecologically responsible action and environmentally friendly production. Our ‘green history’ is evidenced by, among other things, validation in accordance with the EU Eco-Management and Audit Scheme, certification under ISO 14001 and ISO 50001, and environmental product declarations (EPD) for sustainable building. Our EPDs cover our complete range of over 25,000 products.

FSB is your guarantee of maximum planning certainty and sustainability building – made in Germany and putting a global idea to effect.

Made in Brakel  Germany



ErgoSystem® A100



ErgoSystem® E300

Products that transcend form and function

A door handle from FSB is the perfected interface between people and architecture, fitting perfectly into the individual interior design concept. Ergonomic form, material and surface quality come together to create an element that is pleasant to the touch and meets the highest technical standards down to the very last detail.

At FSB we create premium door handles, some of which are now even held in New York's Museum of Modern Art. After all, it takes more than a door to open up a room. FSB provides the perfect coordinated product solution for all established construction elements.

Convenience and safety in the bathroom with the ErgoSystem®

The barrier-free ErgoSystem® E300 in stainless steel and A100 in aluminium is an impressive enhancement to the sanitary area. Common to both system segments is the fundamental notion, unique to the marketplace, of a diagonally aligned, oval grip cross-section that rigorously observes the ergonomics of good grip to deliver unparalleled convenience and dependable support.

A multi-award-winning design that pleases the discerning eye just as much as it does hands on rails proves that functional and ergonomic products can (or, in our view, must) also look good. ErgoSystem® also allows for any setting to be catered to.

We see ErgoSystem® as a 'design for all' concept that focuses on the needs of people from all age groups. The system's comprehensive range includes products tailor-made for those who simply desire a bit more convenience, products which, once used, they will never wish to do without again.

For ErgoSystem® A100, E300 and METRIC®, see page 36 ff.

Discover the
ErgoSystem®:
[www.fsb.de/
ergosystem](http://www.fsb.de/ergosystem)

The FSB DNA

Quality you can touch

Quality of the highest order



For 140 years

Quality is the product of constant learning and questioning. Our expertise has its roots in deep tradition and follows guiding principles that are still alive to this day.

Our own benchmark: better than the standard

FSB regards standards merely as minimum requirements that we strive to exceed far and beyond. Choose dependable quality, durability and sophisticated engineering.

The cost-effective choice

Engineering and design are rated for continuous everyday use as a function of the length of use of buildings. FSB products prove to be good investments right from the start.

Quality guaranteed

As long as our products are professionally installed and used as intended, we offer a five-year warranty on their mechanical function.

Mastery of manufacturing

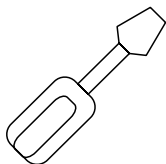

Production expertise

Our manufacturing is top class, from hand-cast workmanship of an artisan nature to automated factory production lines.

From a single source

Our developers and designers, along with our in-house prototype and tool manufacture divisions in Brakel, work hand-in-hand and give us maximum flexibility, even down to individual custom pieces tailor-made for individual requirements.

Perfection

Our passion for detail is what makes our products so unique. Where automated production methods reach their limits, our valiant employees step in to create perfect radii and give the pieces a final polish.

Exceptional flair for aesthetics

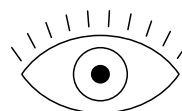

Designer brand

We have cultivated long-standing collaborative relationships with renowned designers and architects from all over the world, like Jasper Morrison, Hans Kollhoff, David Chipperfield, Christoph Ingenhoven, Matteo Thun, John Pawson and many others.

Mastery of materials

We only work with the highest-grade aluminium, stainless steel and bronze. Every material shines with its own unique benefits (see page 14 ff.)

Diverse finishes

Satin matt, fine-blasted, polished to a glossy finish or with neat brush strokes: every finish has its own unmistakable look and feel.

Continuity

From the front door to the bathroom, one range of products coordinated across all elements ensures a consistent fit-out in terms of design and materials.

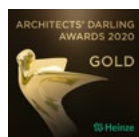

Made in Germany



In central Germany

Everything from office administration to product development and manufacturing takes place at our site in Brakel in eastern Westphalia.

Flexible delivery

We guarantee flexible, quick delivery by keeping over 11,000 items in stock.

Certainty of supply

Certificates of origin and long term supplier declarations for goods with preferential origin status according to EU Regulation no. 1207/2001.

Distinguished excellence



Award-winning

Judges all over the world are regularly impressed with FSB, awarding us and our products with the German Design Award or Iconic Award, for example, or as the Architects' Darling or even Product of the Year.

Certified

We have the right product for virtually any application area: door handles certified under EN 1906, emergency exit and panic exit devices certified under EN 179 and EN 1125, fire safety fittings certified under DIN 18273 and Austrian standards, and even door handles certified by the German Social Accident Insurance association (DGUV). Selected products of our Ergo-System® are certified under DIN 18040 and bear a CE marking.

Sustainable

Environmental product declarations in accordance with EN 15804 certify the eco-friendly quality of our range of over 25,000 products.

Here for you

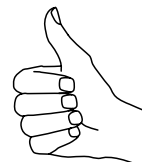

Plant tours

We are happy to open our doors to you. Come see what FSB production is all about, from the blank to the final finished product.

Events and training

Benefit from personal exchange. If you are interested in training, informational events or (architectural) talks, please get in touch.

Downloads

Images, DWG/DXF data, tender specifications, installation instructions, drilling templates and much more can be found at www.fsb.de/catalogue. Visit www.fsb.de/downloads to find all current documentation.

FSB service

Questions? Check out our FAQs, use the live chat feature on our website or go to www.fsb.de/contact to find your direct contact person, who can quickly answer any questions you may have.



FSB Handmade

Your ideas take shape

As a unique one-off or series

Always one of a kind: FSB Handmade leaves no desire unfulfilled. Want a lifting/sliding door handle that matches other components already installed? Need a product in non-standard dimensions? Want to bring your own design idea to life? We are happy to lend a helping hand! Whether you need a unique one-off product or have higher volume needs for large-scale projects, our one-of-a-kind manufacturing expertise makes it all possible.

In order to create your product, a visual representation of it is needed first. The following CAD data is acceptable:

- 3D data such as STEP or IGES
- 2D data such as DXF or DWG

What if you have an idea but its execution is not quite perfected yet? We will work with you to hammer out the details or create a first draft based on your ideas. After conducting technical feasibility checks, we will give you our quote. If you desire, we will first produce a prototype of your product, so you can see it with your own eyes and feel it in your hand. Once our drawing is approved, we will start with production – and you will soon join the ranks of those who can proudly proclaim that they have created an original FSB product.

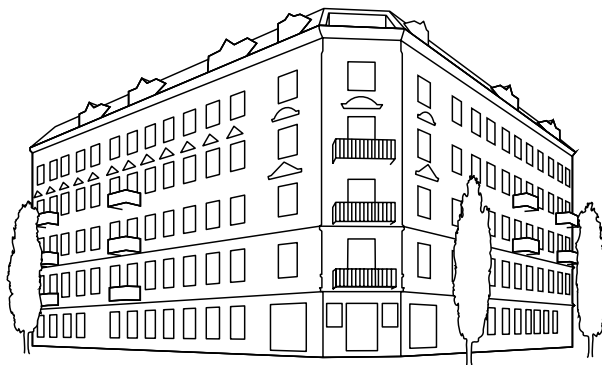

FSB offers universal design options for the following product groups and all established door and window types:

- Door handles
- Knob handles
- Window handles
- Lifting/sliding door fittings
- Narrow-stile door fittings
- Door handles for glass door fittings
- Push/pull pad handles and door pulls (total length max. 500 mm)

Series design with preferred materials

We have numerous designs in stock in a wide range of materials and finishes. We also manufacture models upon request in your preferred finish from your chosen material (aluminium, stainless steel or bronze). (Pictured: design in bronze by Fawad Kazi)



New for old

FSB is familiar with all design eras and styles. Find products with us that give old buildings a new shine. With FSB you can bring any design to life, even in projects involving historical buildings with a protected status.



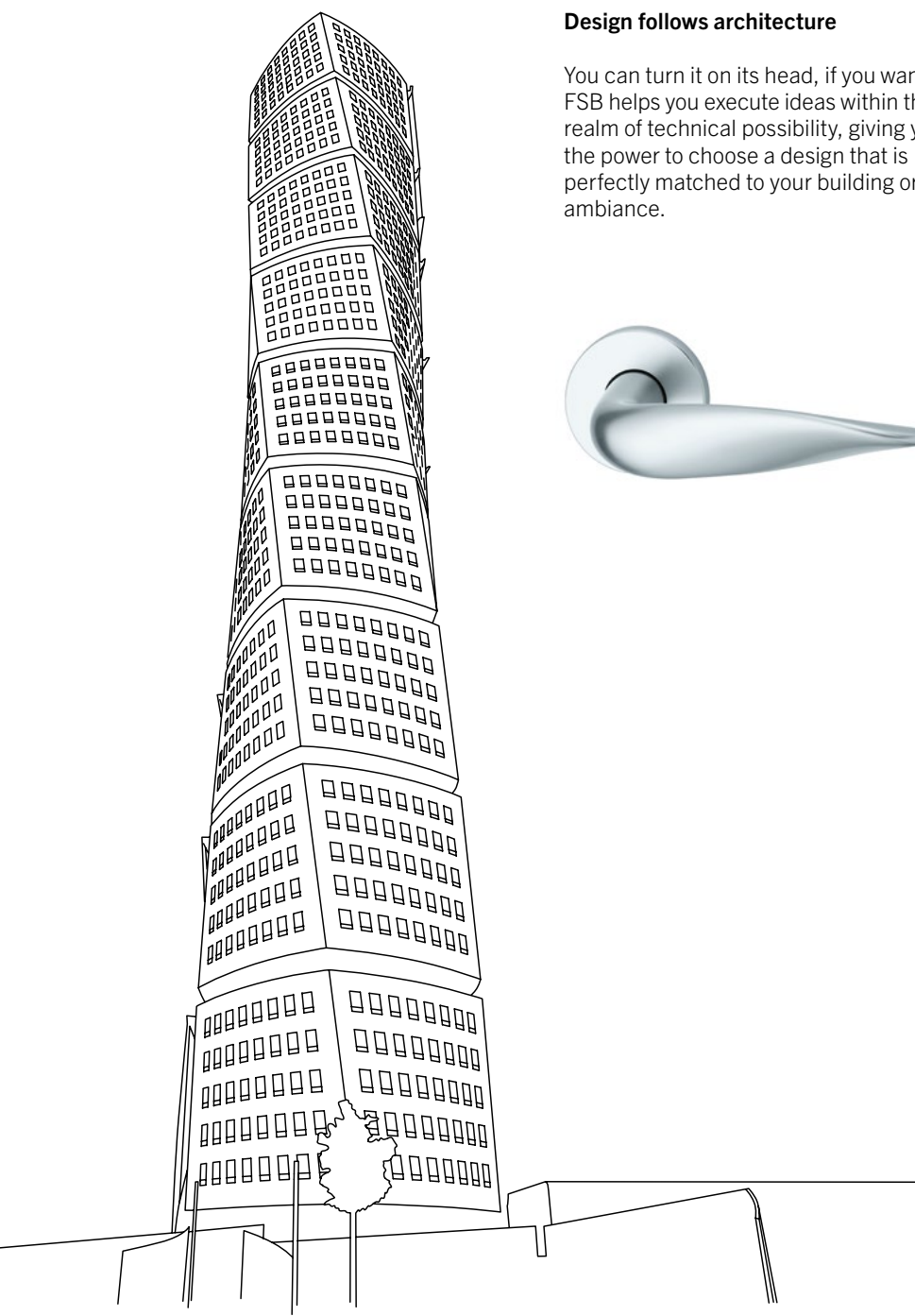

Design follows architecture

You can turn it on its head, if you want: FSB helps you execute ideas within the realm of technical possibility, giving you the power to choose a design that is perfectly matched to your building or ambiance.



Thinking collectively

You can use our product collections to fully fit out all of the doors and windows in your building. Need a fitting for a special application that is not (yet) part of our product range? We'll make the right product for you to guarantee continuity across all construction elements.



FSB Care

Our experience – your safety



Clean performance: reducing germs with fittings and handrails

In highly frequented public buildings, educational institutions, hospitals and nursing homes, infection control is more important now than ever before. FSB offers a wide range of solutions for more safety day to day.

Hands-free door opener: FSB 1287

The FSB 1287 door handle is designed to operate without contact with the hands, providing greater protection against infection and keeping the hands free for other things. The handle is operated by placing the forearm on the angled end of the lever – the return-to-door. The door handle is designed to be especially comfortable for the arm. The FSB anti-infection coating (AIC) is applied to the FSB 1287 as standard.

Multipurpose door handle: FSB 1155

The FSB 1155 model can be operated both with the hand and with the elbow thanks to its ergonomic angular design. Developed on the basis of scientific research conducted by FSB in cooperation with the Fraunhofer Society, the model facilitates safe operation. The FSB 1287 and FSB 1155 are made of stainless steel and are extremely corrosion-resistant and hard-wearing against dents and scratch marks. With stainless steel, an invisible passive layer also naturally forms on its surface, allowing it to easily withstand cleaning agents and disinfectants.



FSB 1287
see page 621



FSB 1155
see page 620

Natural germ resistance: FSB fittings made of bronze

Germs are killed more quickly and thus effectively reduced on bronze surfaces than on other materials due to the high proportion of copper. Clinical studies reveal that up to 99.9% of bacteria on copper-alloy surfaces are destroyed within two hours of contact. Bronze can only be called bronze when the copper–tin alloy consists of at least 60% copper. FSB's high-quality bronze alloy, which consists of 92% copper and 8% tin, constantly regenerates copper ions on its untreated surface, actively depriving multiresistant pathogens of nutrients – for the entire lifetime of a door handle.

**Reduction of pathogens by 99.9%:
the FSB anti-infection coating (AIC)**

Available for nearly all stainless steel FSB products, the anti-infection coating guarantees a reduction of multiresistant pathogens with lifetime efficacy certified under ISO 22196 JIS Z 2801:2010. The coating is scratch-proof (EN ISO 1518) and withstands all commonly marketed cleaning agents and disinfectants. The AIC provides more safety anywhere where lots of people come into contact with door handles, thus increasing the risk of infection. Pathogens are proven to be reduced by over 90% within just one hour of contact. Virtually all germs are destroyed after eight hours. The AIC is an invisible coating and therefore will not affect how the product looks.

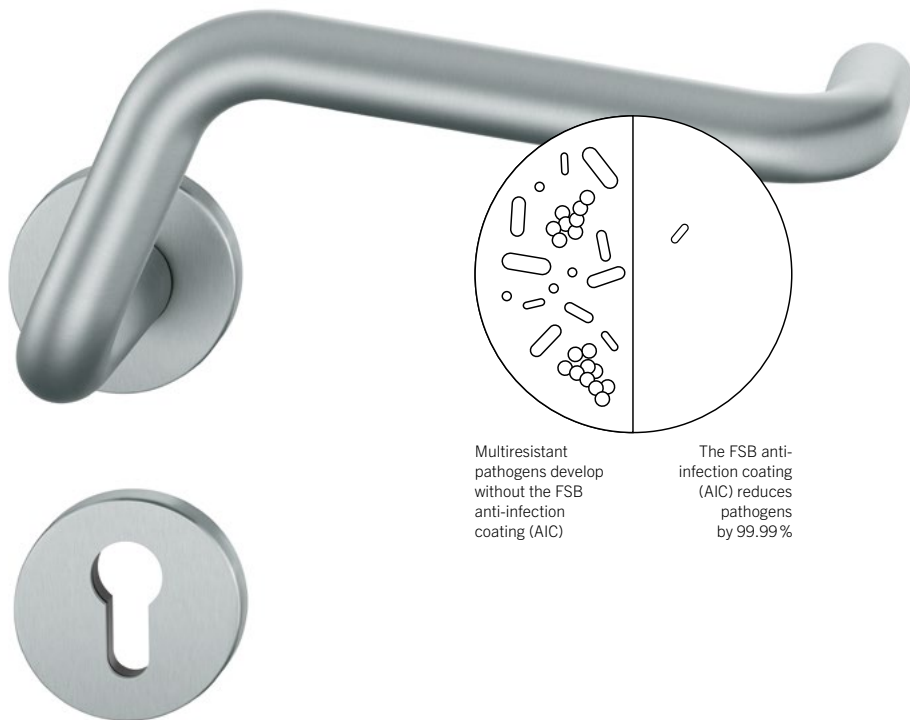

Multiresistant pathogens develop without the FSB anti-infection coating (AIC)

The FSB anti-infection coating (AIC) reduces pathogens by 99.99%

The following stainless steel door handle models, knobs and WC thumb turns are available with the FSB anti-infection coating at short notice. The anti-infection coating is applied to the grip elements: the grip section (female handle), the knob without rose, the WC thumb turn without backplate/rose.



FSB 1016
see page 108

FSB 1023
see page 118

FSB 1053
see page 118

FSB 1070
see page 144



FSB 1076
see page 154

FSB 1267
see page 294

FSB 1268
see page 294

FSB 0802
see page 375



FSB 0829
see page 380

WC thumb turn for backplates and roses



Materials and finishes

High-class materials in good hands

FSB harnesses the special benefits of aluminium, stainless steel and bronze. Metals exude a timeless elegance that leaves their plastic counterparts far behind.

We only work with high-quality, durable, tried-and-tested metals in their natural colours or with a permanent colouring and coating.

The different finishes, in the quality FSB has come to be known for, really bring out the features of the design: blasted finishes provide an especially nice feeling in the hand, the perfect brush stroke underscores the accurate radii and polished finishes give the design an entirely unique shine.

Aluminium

Anodised smooth finish



0105
Polished Silver, Anodised



0205
Satin, Anodised

Aluminium

Blasted velvety matt finish



0410
Bronze Colour, Anodised



0510
Medium Bronze Colour, Anodised (C33)



0710
Dark Bronze Colour, Anodised (C34)



0810
Black, Anodised (C35)

Ordering samples

Our product range is versatile enough to meet any individual requirements. To order samples, please email our Architecture Service team directly: sales@fsb.de

Note that we do not keep all versions of all products permanently in stock, as we are passionate about conserving resources in our production and warehousing processes.

AluminiumPowder-coated smooth finish
(RAL)8220
White, Similar to RAL 9016, Glossy8120
Black, Similar to RAL 9005, Matt8802
Anthracite Grey, Similar to RAL 7016, Glossy8821
Grey-Brown, Similar to RAL 8019, Glossy**Stainless Steel**6204
Brushed Satin Matt6205
Polished6210
Brass-coloured PVD Coating6208
Black Matt PVD Coating**Bronze**7615
Light, Patinated and Waxed7625
Dark, Patinated and Waxed

Materials and finishes

■ Aluminium



FSB 0105
Polished Aluminium
Natural Colour, Anodised



FSB 0205
Aluminium
German Silver Colour

Ordering samples

Our product range is versatile enough to meet any individual requirements. To order samples, please email our Architecture Service team directly: sales@fsb.de

Note that we do not keep all versions of all products permanently in stock, as we are passionate about conserving resources in our production and warehousing processes.

Right from the start, aluminium has been used as a high-tech material, when light weight and high durability are required. It is responsible for some key innovations, and neither space travel, aircraft construction or automotive design would be conceivable without it.

Especially in the second half of the 20th century, aluminium started its triumphal advance into interior design and into design in general. Its technological mystique together with its silvery, glittering surface opened up new horizons in the use of metal in interior design. At FSB this started with the designs by Johannes Potentes in the 1950s. Still today, the expertise in aluminium machining we acquired at that time underpins all FSB ranges of handles made in this marvellous material. Aluminium's natural colour is natural silver (FSB 0105). We recommend this finish for customers who cherish the material's essential attributes.

Aluminium is a light metal (with a density of 2.699 g/cm³) that melts at 660 degrees Celsius. Admittedly, its initial extraction requires a relatively large amount of energy. But this initially negative energy record is made up for by the material's many positive characteristics when in use and recycled. Almost 95 per cent less energy is consumed at the reprocessing stage than during the initial extraction process. What's more, aluminium can be recycled again and again, without any loss.

This featherweight amongst metals is pleasant to the touch, primarily because it is particularly good at adapting to environmental temperatures. FSB only uses pure alloys from the smelters conforming to

DIN 1725 with the following material numbers:

AlMg3: mat. no. 3.3541.02
AlMg1: mat. no. 3.3315
AlMgSi0.5: mat. no. 3.3206

After mechanical machining, the surface is anodised to protect it. FSB uses a standard anodisation process with direct current and a sulphuric acid electrolyte. The oxide layer built up in this standard process is approx. 10 µm thick with a hardness of up to 350 kp/mm² (Vickers), the equivalent of 2,500 to 3,500 N/mm². The silver-white oxide layer can be coloured to extend your design options. FSB uses two methods of colouration:

1. Colouring of the surface and in the centre of the oxide layer by dipping, which is also known as the absorption method. During this process, the initially silver-white anodised aluminium is chemically coloured in organic and inorganic dye solutions. This method results in a lightfastness rating of 6 to 7.
2. Colouring at the base of the pores of the oxide layer. In this method, alternating current is used to electrolytically deposit metals in the previously created silver-white oxide layer. This is also known as a two-stage method and yields a lightfastness rating of 7 to 8.

Once the surface has been coloured it is compacted. This ensures that the colour's resistance to corrosion, light and weather stays within the specified values. Basically, aluminium needs no special care as a material. This artificially created anodised layer protects the aluminium. Dirt can be removed with water and a soft cloth.

Aluminium surfaces can be worn or scratched by harder materials in the course of day-to-day use. Scratches from rings worn on fingers are a typical example. This 'damage' to the aluminium surface may detract from the look of the finish but in no way affects the function of the product. Many users even like a weathered look.

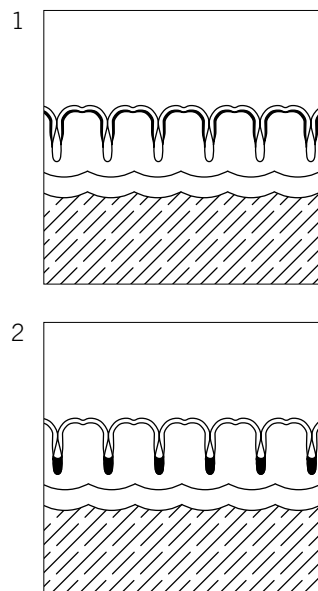

Materials and finishes

■ Blasted aluminium, colour anodised

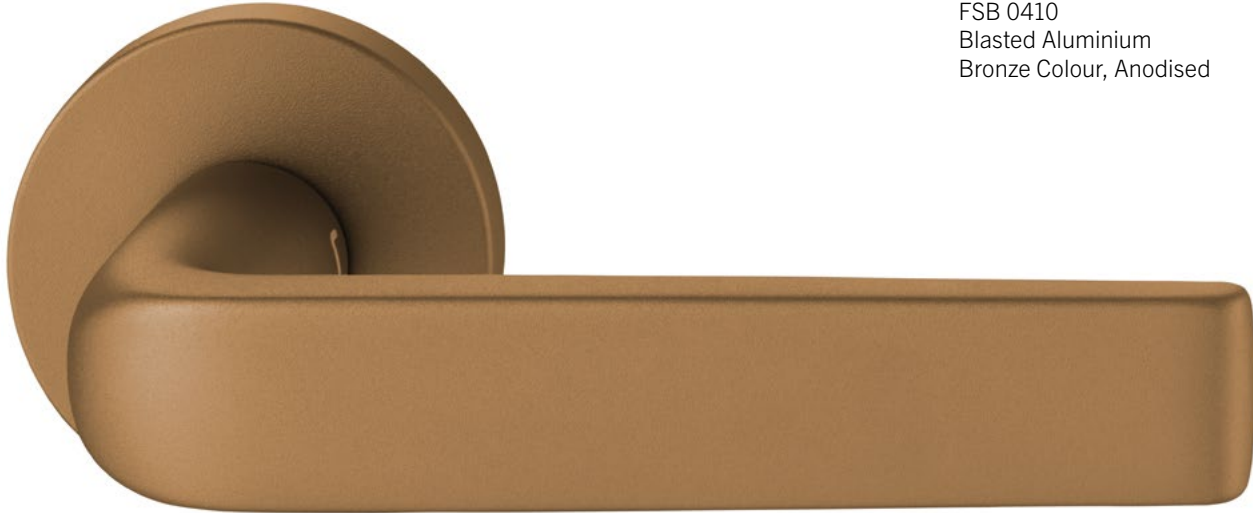

FSB 0410
Blasted Aluminium
Bronze Colour, Anodised



FSB 0510
Blasted Aluminium
Medium Bronze Colour, Anodised (C33)

Ordering samples

Our product range is versatile enough to meet any individual requirements. To order samples, please email our Architecture Service team directly: sales@fsb.de

Note that we do not keep all versions of all products permanently in stock, as we are passionate about conserving resources in our production and warehousing processes.

There has been a discernible shift away from the light colours that once dominated the architectural landscape – covering everything from facades, interiors in general and internal doors. FSB 0510 (medium bronze, C33) and FSB 0810 (black, C35) are shades that echo this colour trend while additionally blending in well with two common facade profile colours.

FSB blasts the aluminium surfaces with fine steel shot before anodising them, resulting in a velvety, satin matt finish. By contrast, it is common practice among profile manufacturers to, at most, grind their profiles prior to anodising them, producing a finish that is simply matt. Notwithstanding the philosophy of finishes expounded here, certain discrepancies of colour and gloss are always to be reckoned with where anodised aluminium is concerned. Extruded profiles respond differently to anodisation than the cast aluminium with which FSB works, due to their different metallurgical structure. Rather than viewing such discrepancies as aesthetic shortcomings, however, they should be seen as forms of accentuation designed to subtly set the handle apart from its host surface.

The standard colour shades referred to have been reproduced as faithfully as printing techniques allow. We recommend requesting colour samples from FSB for more exact colour matching, however. Slight colour variations due to the manufacturing process are unavoidable, especially between different delivered batches.



FSB 0710
Blasted Aluminium
Dark Bronze Colour, Anodised (C34)



FSB 0810
Blasted Aluminium
Black, Anodised (C35)

Materials and finishes

■ Aluminium + colour



FSB 8220
White, Similar to RAL 9016
Glossy



FSB 8120
Black, Similar to RAL 9005
Matt

Ordering samples

Our product range is versatile enough to meet any individual requirements. To order samples, please email our Architecture Service team directly: sales@fsb.de

Note that we do not keep all versions of all products permanently in stock, as we are passionate about conserving resources in our production and warehousing processes.

FSB sees itself primarily as a manufacturer of door and window fittings made of fine metals. We do offer a limited range of colour-coated fittings, however.

We use the cast and ground aluminium models from the standard FSB range as the basis for our coated fittings. Before coating, the parts are subject to a special anodic oxidation process, followed by electrostatic powder-coating, which is a solvent-free painting method. The coat is applied in layers approx. 80 µm thick. The quality of the finish – the lightfastness of the colours, surface hardness, resistance to abrasion, etc. – roughly corresponds to that of anodised aluminium.

If properly fitted and used as intended, the colour-coating on FSB fittings will withstand daily use. Harsh knocks with hard and sharp-edged objects (e.g. rings, keys, boxes, etc.) can scratch the finish. Scratches do not impair function, however.

When making your enquiry, please specify the RAL number of the required colour. Keep in mind that slight variations in colour may occur during manufacture, due to the materials and the processes involved.



FSB 8802
Anthracite Grey, Similar to RAL 7016
Matt



FSB 8821
Grey-Brown, Similar to RAL 8019
Matt

Materials and finishes

■ Stainless Steel



FSB 6204
Stainless Steel
Brushed Satin Matt



FSB 6205
Stainless Steel
Polished

Ordering samples

Our product range is versatile enough to meet any individual requirements. To order samples, please email our Architecture Service team directly: sales@fsb.de

Note that we do not keep all versions of all products permanently in stock, as we are passionate about conserving resources in our production and warehousing processes.

The generic term 'stainless steel' refers to more than 100 different corrosion and acid-resistant steels. We use a chrome-nickel steel for our fittings, which is assigned material number 1.4301 according to DIN 17440 and contains approx. 18% chrome and 8% nickel. This alloy that has been tried and tested in the builder's trade and is in no way equatable with the inferior 'stainless steel' alloys.

Stainless steel is an excellent choice for door and window fittings because its surface is extremely corrosion-resistant, hardly shows traces of dents or scratches even when very roughly treated, is extremely hard-wearing even if in constant use and – primarily due to the chrome and nickel additives in the alloy – is very easy to look after. An invisible passive layer forms on its surface that is even claimed to kill bacteria.

We recommend stainless steel door and window fittings for all heavily used doors, especially in public buildings, office buildings, hospitals, motorway service stations, schools and sports facilities – anywhere where people convene in large numbers and there is a need for easy-care fittings with a long service life.

The independent organisation 'Informationsstelle Edelstahl Rostfrei' (the Stainless Steel Information Centre) approves the use of 1.4301 stainless steel for swimming pools as well, provided the products in question do not have big gaps or welding seams – and naturally, door handles do not have these. It is therefore not the case that 1.4404 stainless steel is the only material that can be used in swimming pools.

In principle, fittings made of stainless steel need no care. Dirt can be removed with a damp cloth.

If signs of rust appear on outdoor fittings or fittings in chlorinated swimming pools over time, this is what is known as 'flash rust', which does not come from the material itself but rather occurs from other material deposited on the surface of the stainless steel. Flash rust can be removed with vigorous rubbing. Our stainless steel in a brushed satin matt finish is particularly resilient.

Our polished stainless steel is an environmentally friendly alternative to chrome-plated finishes and is made to order.

FSB 6210
Brass-coloured PVD Coating
Polished Finish



FSB 6208
Black Matt PVD Coating



We also offer FSB 6210, stainless steel with a brass-coloured PVD coating and polished finish. An additional solid metal finish is applied using a physical vapour deposition (PVD) method. This coloured layer of zirconium nitride (ZrN) is extremely scratch and corrosion-resistant. Intergranular corrosion can no longer occur. FSB can therefore guarantee long enjoyment of the shiny brass look. FSB 6208, stainless steel with black matt PVD coating, is available upon request.

Materials and finishes

■ Bronze



FSB 7615
Light Bronze
Patinated and Waxed

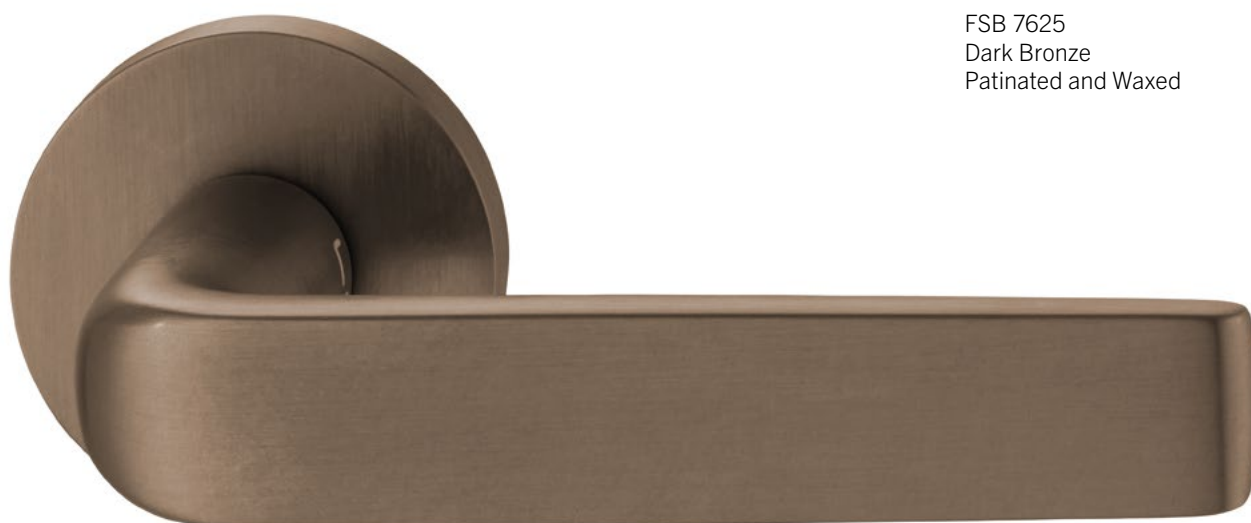

FSB 7625
Dark Bronze
Patinated and Waxed

Ordering samples

Our product range is versatile enough to meet any individual requirements. To order samples, please email our Architecture Service team directly: sales@fsb.de

Note that we do not keep all versions of all products permanently in stock, as we are passionate about conserving resources in our production and warehousing processes.

By supplying hardware in bronze, FSB is tapping into a material that goes back a very long way and gave an entire epoch of human history its name: the Bronze Age. The ability to alloy copper and tin into bronze revolutionised the manufacture of utilitarian objects.

We use a copper-tin alloy for our fittings containing 92% copper and 8% tin. This alloy is designated CuSn8 and is assigned material number 2.1030. Its composition is characterised by its great tensile strength and extreme hardness. Its resistance to wear makes it a prime candidate for products under heavy use every day.

Bronze fittings with FSB 7615 and FSB 7625 finishes are first given a matt finish and then pretreated using a special procedure developed in-house. An immersion bath for metals containing copper mimics the material's natural ageing process. This pre-ageing technique allows us to achieve a typical bronze patina that is every bit as impressive as the patina attained by natural means. The final waxing in the factory protects the finish from discolouration due to external influences which would otherwise have an effect.

With antibiotic-resistant germs cropping up with ever increasing frequency in healthcare and nursing establishments, the disinfectant properties of FSB bronze are taking on a special importance: clinical studies conducted in the USA and UK reveal that 99.9% of bacteria on copper alloy surfaces are destroyed within two hours of contact. This group of bacteria includes the superbug meticillin-resistant *Staphylococcus aureus* (MRSA), one of the most virulent and dangerous germs known. It was also confirmed that if prescribed hygiene measures are implemented at the same time, recontamination is prevented by more than 99%. As a result, this property of the CuSn8 copper alloy used by FSB (UNS designation C52100) has been officially incorporated by the EPA (Environmental Protection Agency) into US building regulations under US registration number 82012-2. FSB bronze fittings also bear the European 'Cu+ Antimicrobial Copper' quality seal (visit www.antimicrobialcopper.com for more information).

Regularly handled bronze fittings are self-polishing in day-to-day use. Any parts with which hands do not come into contact acquire a natural patina as a function of environmental conditions and their surroundings. This change in colour relative to the condition of the finish when delivered is natural to the material and as such does not constitute grounds for complaint, let alone a defect. We use wax to keep the finish in the condition in which it was delivered as far as possible. The wax is used to preserve the bright copper-coloured patina of the bronze and to preclude any natural patina formation during storage, delivery and assembly. We want your bronze fittings to reach your windows and doors 'fresh' and only develop a patina in the course of use.

The wax we use is safe, biodegradable and can be easily removed by wiping it off – no cleaning agents needed. Adding a few drops of cooking oil is known to be effective. Naturally varying environmental influences may lead to slight chromatic fluctuations in the degree of patination between batches. These fluctuations are unavoidable and mean that any fittings supplied at a later date will differ from those already in use on your doors and windows and on which a patina has already begun to form. This progression is natural to the material and depends on environmental factors, and as such does not constitute grounds for complaint, let alone a defect.

Materials and finishes

■ Bronze fittings

Lever/lever sets

1004 
Page 90



1015 
Page 102



1016 
Page 108



1023 
Page 118



1045 
Page 130



1076 
Page 154



1102 *



1106 
Page 178



1119 
Page 178



1163 
Page 236



1242 
Page 266



1267 
Page 294



Knob backplates

19 1964 | 19 1927 
Page 337



19 1963 | 19 1970 
Page 338



* Model FSB 1102 only available in Bronze Light Patinated Waxed 7615

Doorknobs and knob handles

23 0802 
Pages 339, 375



23 0809 
Page 340



23 0811 
Pages 341, 376



23 0812 
Page 341



23 0829 
Pages 342, 377



23 0846 
Page 343



08 0802 
Pages 339, 375



08 0829 
Pages 342, 377



Plug-in handles for doors

15 1004 
Page 91



15 1015 
Page 103



15 1016 
Page 109



15 1023 
Page 119



15 1045 
Page 131



15 1076 
Page 155



15 1102 *
Page 173



15 1106 
Page 179



15 1119 
Page 197



15 1242 
Page 267



15 1267 
Page 295



* Model FSB 1102 only available in Bronze Light Patinated Waxed 7615

Materials and finishes

■ Bronze fittings

Window handles, plug-in handles for windows

34 1004 ■ ■ ■
Page 91



34 1015 ■ ■ ■
Page 103



34 1023 ■ ■ ■
Page 119



34 1076 ■ ■ ■
Page 155



34 1102 ■ ■ ■*
Page 173



34 1106 ■ ■ ■
Page 179



34 1163 ■ ■ ■
Page 237



34 1242 ■ ■ ■
Page 267



34 1267 ■ ■ ■
Page 295



Tee handle for window, lockable window handles

34 3453 ■ ■ ■
Pages 237, 424



34 3460 ■ ■ ■
Page 432



Lifting/sliding door handles, recessed handles

34 1004 ■ ■ ■
Pages 92, 442



34 1016 ■ ■ ■
Pages 110, 443



34 1242 ■ ■ ■
Pages 268, 448



42 4215 ■ ■ ■
Page 449





* Model FSB 1102 only available in Bronze Light Patinated Waxed 7615



Lever handles for narrow-stile doors

09 1004 
Pages 92, 94





06 1015 
09 1015 
Pages 104, 106



06 1016 
09 1016 
Pages 110, 112





06 1023 
09 1023 
Pages 120, 122





09 1043 
Pages 180, 182



06 1045 
09 1045 
Pages 132, 134



06 1053 
09 1053 
Pages 120, 122



09 1076 
Pages 156, 158





09 1102 
Pages 174, 176





09 1106 
Pages 180, 182





06 1134 
09 1134 
Pages 92, 94





06 1163 
09 1163 
Pages 238, 240





06 1164 
09 1164 
Pages 238, 240



06 1243 
09 1243 
Pages 268, 270



06 1268 
09 1268 
Pages 296, 298



Doorknobs for narrow-stile doors, thumb turn, slide-on roses

07 0829 
Page 481





07 0846 
Page 481



03 0418 
Pages 482, 685



17 1765 
17 1766 
Page 485



Materials and finishes

■ Bronze fittings

Glass door fittings

13 4220 
Pages 506, 507



23 0802 
Page 516



23 0829 
Page 517





Door pulls

66 6506 
Page 657



66 6507 
Page 657



66 6522 
66 6523 
Page 676



66 6524 
Page 652



66 6535 
Page 644



66 6536 
Page 645



66 6538 
Page 646



66 6602 
Page 656



66 6662 
Page 669



66 6681 
Page 674



Door pull with Fingerscan

24 6607 
Page 706



Security fittings

73 7375  Page 724



73 7376  Page 725



73 7378  Page 727



73 7379  Page 728



73 3249  Page 737



73 7395  Page 739



73 7395  Page 739



73 7396  Page 741



Sliding door handles

42 4211  Page 562



42 4250  Page 550



42 4251  Page 551



Sliding door handles with bronze grip elements

42 4260  Page 563



42 4261  Page 563



42 4262  Page 564



42 4263  Page 564



42 4264  Page 565



42 4265  Page 565





Bathroom hardware ErgoSystem® A100, E300 and METRIC®

2



One system, two variants: the ErgoSystem® E300 and A100 ranges allow completely barrier-free solutions to be incorporated into any architectural scheme and into any setting. The ErgoSystem® boasts variants in two attractive materials, elegant design elements, a wealth of colour combinations and an incomparable product depth that leaves nothing to be desired.



| | |
|----|------------------|
| 38 | ErgoSystem® E300 |
| 43 | METRIC® |
| 44 | ErgoSystem® A100 |

Bathroom hardware

ErgoSystem® A100, E300 and METRIC®



Functional, ergonomic, visually appealing: ErgoSystem®

The multi-award-winning barrier-free ErgoSystem® E300 or A100 is a treat not only to the palm of the hand but also to the discerning eye. What's more, FSB also provides a range of attractive bathroom accessories with METRIC®.

ErgoSystem® E300

The ErgoSystem® E300 (E = stainless steel, 300 = 'high grade' / heavy duty) embodies peerless system depth, superior design and well-conceived functionality. Flexibility is guaranteed by this extensive system comprising more than 400 products made of satin matt or polished stainless steel of the highest quality. Stainless steel is extremely corrosion-resistant and also very easy to care for. An invisible passive layer also naturally forms on its surface, allowing it to easily withstand cleaning agents

and disinfectants. That's why it is the first choice especially for premium fixtures and fittings, such as those installed in optional service areas in hospitals, nursing homes and hotels – anywhere where high standards need to be met.

ErgoSystem® A100

The ErgoSystem® A100 (A = aluminium, 100 = budget-friendly/heavy duty) scores high in terms of pricing, handling and coordinated interiors. The variable colour combinations mean that the system can be individually adapted to create a specific ambiance – whether those combinations are tone-in-tone or chosen with specific attention to Light Reflectance Values. The powder-coated components made of premium aluminium also feature impressive corrosion resistance. Installation is

easy and precise thanks to an assembly shoe concept with built-in compensation for lateral play of ± 2 mm.

METRIC®

Form follows elegance. Bathrooms have long since ceased to be purely functional rooms. The emphasis has shifted far more towards feeling good and pampering all of the senses. Well-designed accessories have a key part to play in this. METRIC® bathroom accessories are a joy to behold and look right in any setting, with their satin matt or polished stainless steel finishes. At the heart of this collection is a design concept based on geometric shapes. As an alternative to conventional screw fixing, FSB also offers a high-adhesion bonding technique that leaves no residues if removed.

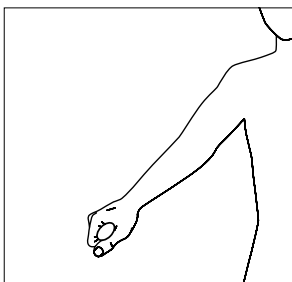
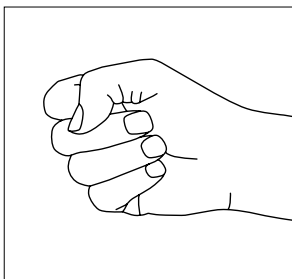
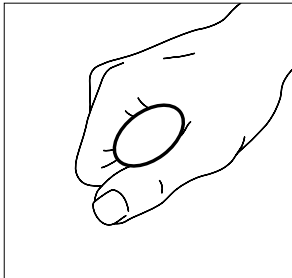

FSB ErgoSystem®: unparalleled comfort and dependable support

When you've been making tools as extensions of the human hand for as long as FSB has, you come to learn a few things. The insights we've gained over the years have been incorporated in the development of the ErgoSystem®. For example, hands naturally fold around an oval shape when gripping.

Both the ErgoSystem® E300 and A100 feature a diagonally aligned oval grip cross-section that is unique to the marketplace. Such a grip design consistently follows the laws of grip ergonomics and delivers unparalleled comfort and dependable support. There is a difference between taking hold of an object and enclosing it. Enclosure involves the whole surface of the hand and hence a far more distributed transmission of force. We all resort to it instinctively whenever we have to support our own body weight.

The ideal grip shape is oval

An oval cross-section conforms particularly well to the laws governing the anatomy of the hand. The hand encloses the elliptical cross-section snugly. The effort is distributed evenly among all finger joints and optimum use is made of all joints of the hand including the wrist. As a result, far less force needs to be exerted by the hand to prevent loss of grip than with a circular cross-section. The oval is therefore the ideal shape for the grip cross-section of handles and rails and offers the greatest possible support, especially if it is rotated 45° to tilt forward diagonally. This shape and orientation follow the natural movement of the arm and grip of the hand as a person reaches out to take hold of something. The arm comes out in a diagonal motion from the shoulder and the hand encloses around the object, forming a sturdy triangle that connects the hand, shoulder and the area the person is standing on. As a result the force is able to be transmitted from the body through the arm to the hand with optimum effect.

Benefits at a glance



The ideal grip shape is oval

The unique elliptical design of the grip cross-section allows it to be firmly gripped.



Custom production

Bespoke lengths and product variants at attractive prices



High durability

Suitable for constant daily use with no loss of function



Flexibility

Versatile solution for flexible, needs-based fit-outs with barrier-free, reversible components



Minimum exertion of force

Easy to handle thanks to ergonomic oval grip cross-sections, shower-head holders that can be operated with one hand and spring-assisted drop-down support rails



Made in Germany

FSB develops and manufactures its products exclusively in Brakel in eastern Westphalia



In-house tool manufacture

Speedy and flexible production



Award-winning

The Red Dot Design Award and ICONIC AWARD to name but two; selected products bear a CE marking, certified under DIN 18040



Innovationspreis



Bathroom hardware

ErgoSystem® E300

The ErgoSystem® E300 in stainless steel comprises over 400 products and is suitable for all application areas. This comprehensive range concentrates on grab rails, drop-down support rails and seat solutions that can be combined with the most diverse accessories.

Discover the ErgoSystem®:
www.fsb.de/ergosystem

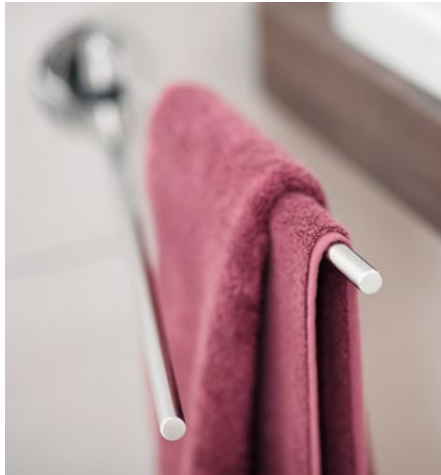

Premium line in stainless steel

It is not without reason that ErgoSystem® E300 in stainless steel, a treat not only to the hand as it grips but also to the discerning eye, has established itself over the past ten years and more as the Number One choice amongst architects and clients who lay particular store by convenience and design.

ErgoSystem® E300 is helpfully at hand without having the aura of a clinic or rehab equipment. With its timeless good looks, it will suit any bathroom architecture perfectly, enhancing levels of comfort without looking out of place. The principle informing the ErgoSystem® derives

unequivocally from the ergonomics of grip. The diagonal alignment of its oval cross-section – a unique market design – affords the hand optimum gripping quality whilst reducing the force it exerts when taking hold of the hardware.

Flexibility is guaranteed by a completely barrier-free system comprising more than 400 products that can be combined and added to in line with the application in hand. ErgoSystem® E300 facilitates the flexible planning of exclusive fit-outs through a comprehensive range of grab rails, drop-down support rails and seat solutions that can be combined with the

most diverse of accessory items so as to add further functions as specifically required. The range of add-on products with matching function and system properties includes shower rails with showerhead holder, care-responsive products such as splash guards and safety belts, and classic sanitary accessories such as towel holders, storage trays and mirrors. Top-quality machining and the exclusive use of premium materials are part and parcel of the FSB tradition. Stainless steel with a satin matt sheen is the number one choice. Seat sections are in kind-to-the-skin PUR.



Flexibility

With A-Flex, FSB offers a well-conceived means of flexibly and demand-responsively fitting spaces out with barrier-free components from the ErgoSystem® E300 range. A-Flex can be particularly recommended for hoteliers or the operators of hospitals with private wards, who can use it to cater to the individual or acutely changing needs of guests and patients. The system yields benefits in the form of significantly lower costs for the initial fit-out, as the spaces concerned are merely fitted with an A-Flex support plate and use can be made of drop-down support rails and tip-up shower seats as required.

Anti-ligature variants of selected products from the ErgoSystem® E300 range are additionally available for use in special areas such as prisons, forensic units or psychiatric establishments.

FSB ErgoSystem® has also been accorded the quality kitemarks of the German Society for Gerontological Technology and the Rhineland Technical Inspection Agency. ErgoSystem® has – like all products by FSB – been certified in accordance with EN 15804, allowing it to fulfil even the most ambitious prerequisites for sustainable building.

Finishes

- ① FSB 6204, Satin Stainless Steel
- ② FSB 6205, Polished Stainless Steel

Bathroom hardware

ErgoSystem® E300 Overview

Drop-down support rails



Wall-mounted/drop-down support rails



A-Flex drop-down support rails

Supporting leg



Backrest



Armrest



Push-button actuators



Grab rails and handrails

Handrail combinations



Storage trays



Grab rail



Angled rails



Wall-mounted support rails



Floor/wall-mounted support rail



Seats

Suspended seats



Tip-up shower seats



Shower and bath stool



Free-standing stool



Shower rails

Shower rails



Shower attachments



Shower curtain rails



Bathroom hardware

ErgoSystem® E300 Overview

Accessories

Utensils tray



Cup holder, soap holder



Soap dispenser



Tilting mirror



Wall mirror



Towel rails



Hooks



Hooks (coloured)



Toilet roll holders



Toilet brush set



Walking aid holder



Splash guard holders



Doorstop



Bathroom hardware

METRIC® Overview

Shower rail



Utensils tray



Cup holder, soap holder



Soap dispenser



Bath towel rail



Bath towel rail



Hand towel rail



Wall hook, coat hook



Spare toilet roll holder



Spare toilet roll holder



Toilet roll holder



Oval toilet brush set



Round toilet brush set



Doorstop



Bathroom hardware

ErgoSystem® A100

The ErgoSystem® A100 in aluminium can be individually adapted to suit any interior and create a specific ambiance thanks to its variable colour combinations. Brackets angled from the wall open up the space behind the handrails, making them especially comfortable to grip.

Discover the ErgoSystem®:
www.fsb.de/ergosystem



Ergonomic, good-looking, attractively priced, in aluminium

Whereas ErgoSystem® E300 is often preferred for exclusive fit-outs of, for instance private wards or hotels, ErgoSystem® A100 likewise brings FSB quality to budget-sensitive ventures.

ErgoSystem® A100 is perfectly geared to virtually any application and location. Randomly configurable sets of handrails with bespoke profiles that can be cut to length on site make for simplified planning and assembly. The rails combine with our multiply award-winning shower-head holder for singlehanded operation to yield an ideal fitment level for shower areas. Shelf surfaces with and without retention bars are supplied in standard dimensions as well as in customised lengths. The drop-down support rail is particularly flexible owing

to its not being handed. Wall rails of variable length, a fixed safety rail, towel holders, wall hooks and toilet-roll holders round off the ErgoSystem® A100.

Variable colour constellations

The ErgoSystem® A100 can be custom-adapted to specific interiors and settings by dint of its variable colour constellations. The colours of brackets / structural parts and hand/grab rails can be freely combined, thus facilitating sufficient contrast to ensure optimum visibility and readability within a space, something that makes life safer and more convenient for elderly people with poor eyesight in particular (Light Reflectance Value). Safe gripping can optionally be aided by selecting hand-holds and brackets in different colours.

Conversely, those for whom the issue of contrast is less critical – be they young or old – can simply deploy the different colours as an interior-design style tool. ErgoSystem® A100 components can be imaginatively adapted to the colour, finish and sheen of tiling and solutions devised whereby products discreetly merge with their background. Though they can be taken for granted as part of a given spatial configuration, they nevertheless have a strong identity of their own, adding a bespoke touch to any interior.

The ErgoSystem® A100 cuts quite a dash in assembly terms too: simplified design engineering has given rise to fewer parts and these, in turn, are child's play to fit adopting the assembly-shoe concept. Visible parts and those of importance for



Unicolour coatings

the assembly process are decoupled from one another, which considerably simplifies fitting them and pre-empts assembly errors.

Grab rails, drop-down support rails and tip-up shower seats are engineered in such a way that they can be detached when not in use and their permanently mounted bearer plates concealed by means of a cover-plate. This allows products to be fitted as and when required.

- ① FSB 8220, Anemone White, Similar to RAL 9016
- ② FSB 8224, White Matt, Similar to RAL 9016
- ③ FSB 8803, Oyster Grey, Similar to RAL 7040
- ④ FSB 8809, Anthracite Grey Metallic, Similar to RAL 7016
- ⑤ FSB 8849, Black Matt, Similar to RAL 9005

Combined coatings

- ⑥ FSB 8223: Brackets/holder FSB 8829, Aluminium Grey Metallic Handrail/rail FSB 8220, Anemone White
- ⑦ FSB 8810: Brackets/holder FSB 8220, Anemone White Handrail/rail FSB 8803, Oyster Grey
- ⑧ FSB 8811: Brackets/holder FSB 8829, Aluminium Grey Metallic Handrail/rail FSB 8809, Anthracite Grey Metallic

Bathroom hardware

ErgoSystem® A100 Overview

Drop-down support rails



Drop-down support rails

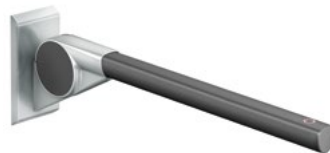

Drop-down support rail with function buttons

Supporting leg



Grab rails and handrails

Handrail combinations



Corner storage trays



Angled rails



Grab rails



Storage trays



Seats

Suspended seats



Tip-up shower seats



Backrest



Shower rails

Shower rails

Shower attachments

Shower curtain rails



Accessories

Utensils trays

Cup holder, soap holder

Soap dispenser



Wall mirror

Hand towel rails

Hooks



Toilet roll holders

Toilet brush set







In addition to excellent design on the outside, FSB cares about what's on the inside as well. Our solutions address the needs of modern residential and commercial buildings and regularly exceed the applicable standards. The FSB AGL® and FSB ASL® bearings and our new FSB adaptor system set new standards in functionality and durability. (Pictured: FSB 42 4212 sliding door handle, FSB 23 0802 door-knob, FSB 1075 lever handle)

Photo: Klemens Renner
Project: Haus Schulzendorf, Brandenburg
Architectural firm: transstruktura



| | |
|----|-----------------------|
| 52 | FSB bases |
| 54 | FSB adaptor system |
| 56 | FSB ASL® |
| 58 | FSB AGL® |
| 61 | Technical information |

Bearing and adaptor technology

FSB bases at a glance

The FSB brand represents sophisticated engineering of the highest order. In tests and everyday use, our products again and again prove themselves to be far better than the standard. Our well-engineered bearing technology sets new benchmarks in terms of reliability, flexibility and ease of assembly.

This chapter presents what is the core of our sets, concealed inside the rose: the FSB AGL® and FSB ASL® bearings and our innovative adaptor system. All current door handle designs are compatible with the adaptor system and our bearings.

FSB adaptor

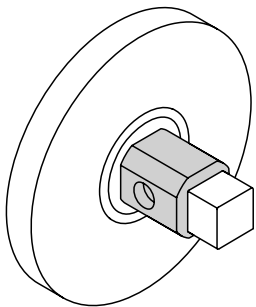

- Component (not a bearing) of the base, e. g. including FSB ASL® and FSB AGL®
- Makes it possible to configuring a fitting based on the kit-system line
- One female handle for all applications
- Products can be flexibly combined
- Turnably fixed adaptor
- Simplified, convenient installation

Note: fire safety variants of products are not available as individual parts and must always be ordered as a complete set.

The following products are available with the adaptor system as individual parts:

- Backplates with visible fixing
- Renovation backplate
- Cut backplates/roses with visible fixing
- Standard flush-fitted roses
- Glass door fittings (available with or without the FSB AGL®/ASL® rose)
- Security fittings
- In-line lever handles for narrow-stile doors
- Individual components for narrow-stile doors
- Plug-in handle for internal door (drilling possible on the side and from below)
- Window handles and plug-in handles for windows (can also be ordered as a complete package)

The FSB adaptor system is not a bearing, but rather a design detail that lends a previously unmatched degree of flexibility when handling sets or individual components: from ordering to installation, you benefit from the ability to combine components. The FSB AGL® and FSB ASL® bearings are both equipped with an adaptor.

Lever/lever sets (including those with cut roses/backplates or with roses/backplates with visible fixing), lever/knob sets, WC sets, glass door fittings, fittings for narrow-stile doors, security fittings, window handles, plug-in handles, etc. are all equipped with the adaptor – but not necessarily with the FSB AGL® or FSB ASL® bearing (and positive mechanism spring, for example).

Available individual parts can be found starting on page 318.

FSB ASL® bearing





12  FSB ASL®

- For all types of buildings
- Turnably fixed bearing with adaptor
- Positive mechanism type A
- Certified under EN 1906 class 4
- Stainless steel-reinforced base
- M5 stainless steel fixing
- Operating angle up to 45°
- Non-handed; can be used on right-hand or left-hand doors
- 20 mm door thickness increments, door thickness can be adjusted
- Available as a set and also as individual parts
- Through-fixing or face fixing
- Quick installation
- Concealed handle bushing
- Fire resistance in accordance with EN 1634-1.

FSB AGL® bearing



72  FSB AGL®

- 76  Heavy-duty fitting FS (fire safety)
- 79  Heavy-duty fitting EN 179 (fire safety, emergency exits)

- For heavy doors with high traffic
- Turnably fixed compensating bearing with adaptor
- Compact design: interlocking spindle/female handle connection
- Positive mechanism type B
- 0° position
- Certified under EN 1906 class 4
- Fire resistance (76, 79) in accordance with DIN 18273 (FS variant) and EN 1634-1
- Solid stainless steel base with plastic cover
- Tolerance compensation
- Operating angle up to 35°
- DIN direction can be flexibly changed
- Available as a set
- Through-fixing
- Quick installation
- Concealed handle bushing

The following products are available with the FSB ASL® and FSB AGL® bearings as sets or – in the case of FSB ASL® – also available as individual parts for combination:

- Rose for lever/lever set
- Rose for WC set
- Rose for lever/knob set
- Short/long backplate for lever/lever set
- Short/long backplate for WC set
- Short/long backplate for lever/knob set
- Broad backplate

Bearing and adaptor technology

FSB adaptor system

The FSB adaptor system provides a level of flexibility that has never before been known when handling sets or individual parts: from ordering to installation, you benefit from the ability to combine components.



Product variants

- Lever/lever sets
- Flush-fitted sets
- Lever/knob sets
- WC sets
- Long backplates
- Short backplates
- Broad backplates
- Glass door fittings
- Narrow-stile door fittings
- Security fittings
- Window handles
- Plug-in handles

Turnably fixed adaptor

Transferring tensile and compressive forces to the entire surface of the base (with FSB ASL® and FSB AGL®) relieves strain on the lock and the fitting overall, extending the service life of the components and therefore representing a significant cost saving.

Flexible combinations

The FSB adaptor system is not a bearing, but rather a design detail that provides maximum flexibility when handling sets or individual components. Components can be combined with sets as needed or (re)-ordered as individual parts.

Simplified, convenient installation

The female handle can be inserted at any point in the construction phase because it is not permanently fixed to the base. The result is maximum flexibility and the ability to install a larger amount of fittings within the same amount of time. The simple installation means that complaints due to damage or installation errors are significantly reduced.

Diverse material selection

FSB offers a unique selection of different finishes and materials – based on aluminium, stainless steel and bronze – for the product variants specified here, which are equipped with the FSB adaptor.

One female handle for all applications

The ability to flexibly combine individual parts brings with it simplified warehouse logistics and supply to retailers, contractors and end customers. Individual parts can be stored without tying up too much capital. Responding to individual requirements is quick and easy, saving the customer time and money, for example, when implementing a special design request.

Suitable for both sides

The adaptor can be used on either side, making it suitable both for right-hand and left-hand sets alike (except FSB AGL®).

Bearing and adaptor technology

FSB ASL® for all types of building

FSB ASL® sets new benchmarks – and offers full flexibility for retail, warehousing and construction. A positive mechanism and variable door thickness only add to the value of this bearing.

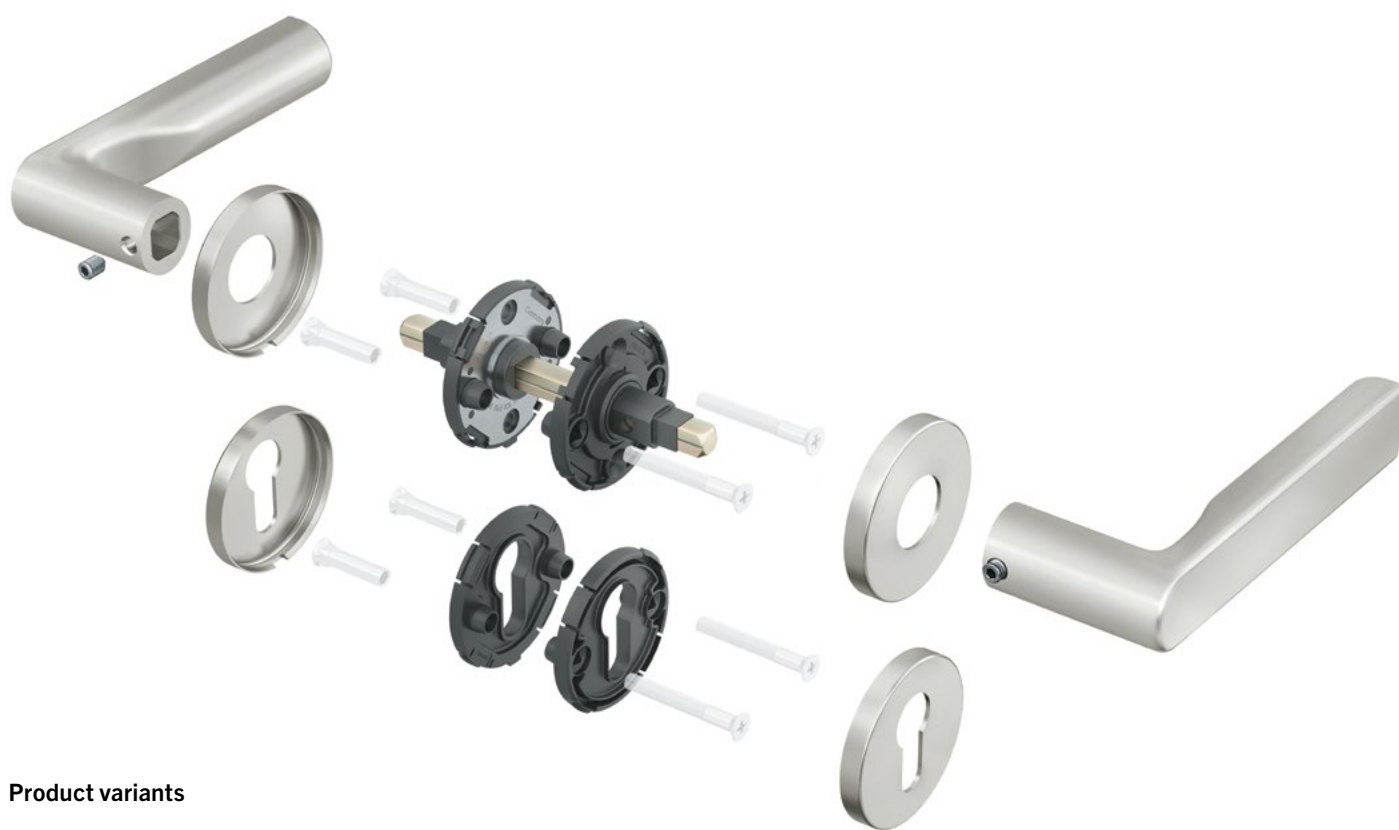

Product variants

- Rose sets (round + angular, surface-mounted) with profile cylinder (PC), warded lock (WL) and Chubb round cylinder (CH-RC) keyways as well as for WCs
- Short and long backplate sets (oval + angular) with profile cylinder (PC), warded lock (WL) and Chubb round cylinder (CH-RC) keyways as well as for WCs
- All variants as lever/knob sets
- Full spindles for door thicknesses 39 to 58 mm
- Door thicknesses 29 to 98 mm also available; other thicknesses available upon request
- Spindle thicknesses 7, 8 and 8.5 mm
- Available in materials aluminium, stainless steel and bronze

Classification code

- Tested internally at FSB:
 - 1,000,000 operating cycles
- EN 1906 grade 4
- Spring-assisted

12  4 | 7 | - | B* | 1 | 5** | 0 | A

* testing in accordance with EN 1634-1
** aluminium and stainless steel only

Turnably fixed adaptor

Low-friction plain bearing bushings made of thermoplastic Grivory® construction material guarantee the maintenance-free function of the FSB ASL® sets over the long term with no wear and tear.

Delivered as a set

The FSB ASL® is delivered as a set with no pre-assembly required. The components of the sets are also supplied as individual parts if necessary.

Installed in a flash

The adaptor technology allows for extremely quick and easy installation, because the rose base is first screwed onto the door without covers and door handles, and also no longer has to be screwed 'past' the handle neck.

Design feature

The door handle conceals the guide ring.

Full spindle

The full spindle in thicknesses of 7, 8 and 8.5 mm covers door thicknesses from 39 to 58 mm all in one product. Door thicknesses from 29 to 98 mm are also possible (other thicknesses are available upon request).

Fire resistance

The FSB ASL® guarantees fire resistance in accordance with EN 1634-1.

Fastening

The set is fastened using either an M5 stainless steel through screw fixing with stabiliser lugs and steel threaded bushing or using four wood screws without stabiliser lugs.

Diverse material selection

FSB offers a unique selection of different finishes and materials for FSB ASL® – based on aluminium, stainless steel and bronze.

Positive mechanism type A

The integrated positive mechanism conforms to standard EN 1906, type of operation A, and facilitates an angle of rotation of up to 45°. The built-in positive mechanism springs work to actively assist the lock follower springs. This interplay prevents even heavy door handles from sagging.

Suitable for both sides

The positive mechanism works in both directions, allowing the sets to be fitted for either right-hand or left-hand doors. This benefit applies to everything including lever/knob sets with symmetrical door handles – even these sets can be used universally on either side!

Adjustments to door thickness

Two female handles and one full spindle allow for on-site adjustments to be made for differing door thicknesses using the accompanying accessory bag.

Tensile strength

The combination of stainless-steel reinforcement and GFR plastic significantly enhances the tensile forces to which FSB ASL® sets can be subjected.

Cover rose/plate

The two-part roses and backplates are fastened precisely using tried-and-tested FSB clip technology.

WC sets and roses

FSB WC rose sets are available with the FSB ASL® bearing both as a set and also as individual parts. Find your desired door handle model and the associated product code on page 76 ff. The unlocking device and indicator are supplied in the accompanying accessory bag (see page 348 ff.).



Bearing and adaptor technology

FSB AGL® for heavy and FS heavy-duty doors and emergency-exit devices

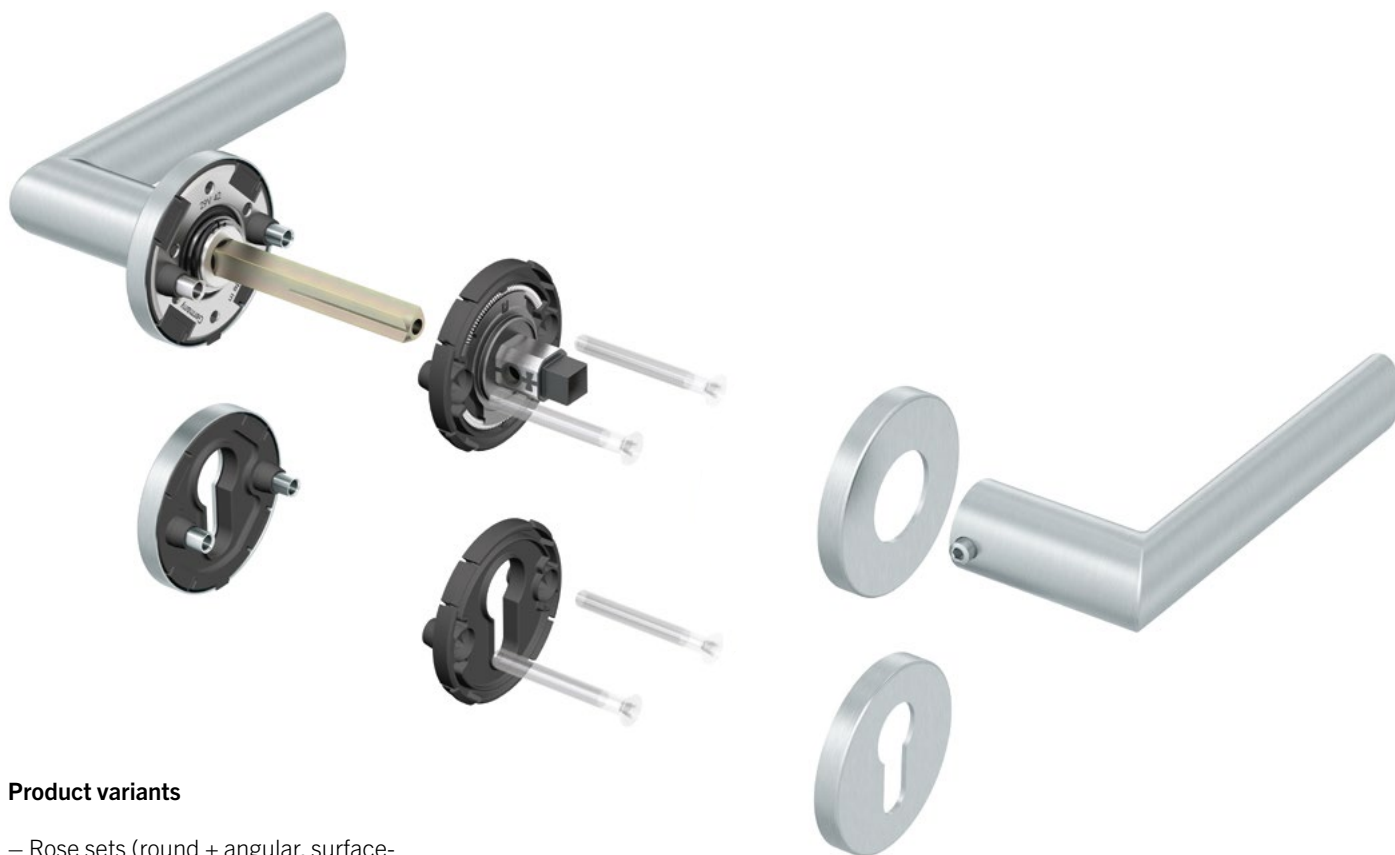

The FSB AGL® has represented a category of unbeatable heavy-duty fittings for commercial properties for decades, impressing architects, contractors, builders, operators and investors alike with its high performance.



Product variants

- Rose sets (round + angular, surface-mounted) with profile cylinder (PC), warded lock (WL) and Chubb round cylinder (CH-RC) keyways as well as for WCs; also available flush-fitted, depending on the door handle model
- Short and long backplate sets (oval + angular) with profile cylinder (PC), warded lock (WL) and Chubb round cylinder (CH-RC) keyways as well as for WCs
- All variants as lever/knob sets
- Standard variant suitable for door thicknesses 39 to 48 mm
- Door thicknesses 29 to 98 mm also available; other thicknesses available upon request
- Spindle thicknesses 8, 8.5 and 9 mm
- Available in materials aluminium, stainless steel and bronze

Classification code

72  4 | 7 | - | 0 | 1 | 5* | 0 | B
 76  4 | 7 | - | B | 1 | 5* | 0 | B
 79  4 | 7 | - | B | 1 | 5* | 0 | B

* aluminium and stainless steel only

Heavy-duty version

The FSB AGL® is suitable for heavy doors with high traffic and emergency exit devices.

FSB AGL® compact fitting

The sets comprise two pre-assemblies: one fully assembled male-handle side (on the left in the figure) and an associated female handle side with a positive mechanism (on the right in the figure).

Turnably fixed compensating bearing with adaptor

The spring bearing made of tempered steel in GFR plastic and the guide neck bearing in Teflon-coated, low-friction plain bearing bushings ensure maintenance-free function over the long term with no wear and tear.

Tolerance compensation

The FSB AGL® compensates for installation and production tolerances in the door drill holes, lock/lock mortise and square spindle.

EN 1906

The FSB AGL® is assigned category of use grade 4 with more than one million tested operational cycles.

Snug fit

The interlocking spindle connection in the set transfers tensile forces to the opposite side of the door.

Full spindle with groove

The full spindle with groove has spindle thicknesses of 8, 8.5 and 9 mm, making it suitable for door thicknesses 39 mm and greater.

Design feature

The door handle conceals the guide ring.

Through-fixing

The roses are fixed through with M5 stainless steel screws.

Installed in a flash

The adaptor system makes effortless installation possible, without having to screw 'past' the door handle, since the female handle is separate from the base of the rose/backplate and is pushed onto the adaptor and secured with a grub screw only after the half-set has been screwed into place.

Fire resistance

The FSB AGL® guarantees fire resistance in accordance with DIN 18273 (FS variant) and EN 1634-1.

Diverse material selection

FSB offers a unique selection of different finishes and materials for FSB AGL® – based on aluminium, stainless steel and bronze.

Positive mechanism type B

A positive mechanism with a pre-loaded spring – as described in EN 1906 for type B operation, grade 4 category of use – permanently prevents the door handles on heavy, high-traffic doors from sagging and facilitates an angle of rotation of up to 35°.

0° position

FSB AGL® sets also feature a 0° stop built into the positive mechanism, which ensures the door handles are always perfectly horizontal when at rest. The positive mechanism offsets any effects of the lock spring right from the outset.

DIN direction can be flexibly changed

The adaptor concept means that it is possible to change the DIN direction for FSB AGL® lever/knob and half-sets by replacing the base (applies to 8 mm and 8.5 mm spindle). Adaptors can be supplied loose.

WC sets and roses

FSB WC rose sets are available with the tried-and-tested FSB AGL® heavy-duty bearing as a set. They have a thumb turn on the inside and an emergency release on the outside. Emergency release key 34 3464 must be ordered separately. Find your desired door handle model and the associated product code on page 76 ff.

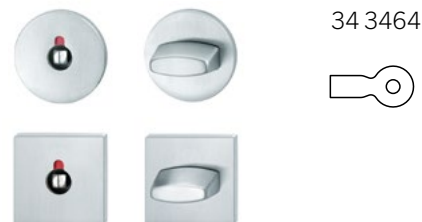

61 **Technical information**

Bearing and adaptor technology

Technical information

EN 1906 fittings

Our heavy-duty fittings come out on top, going far beyond the standard in all categories.

Standard EN 1906 defines the requirements and test methods for door handles and doorknobs. The practical value and

classification of fittings must be judged across the entire eight-digit grading system.

Certification under EN 1906 is only granted once all test criteria and the required results are met.

Perfection down to the last detail – our heavy-duty fittings pass with flying colours in each of the eight categories, also known as ‘digits’:

Classification code for FSB AGL® (8, 8.5 and 9 mm)

| 4 | 7 | – | B* | 1 | 5 | 0 | B |
|-------------------------------|-------------------------------------------------------------|-----------|------------------------------------------------------|-------------------------------------------------|--------------------------------------------------------------------------|------------------------|-------------------------------|
| Category of use Grades 1–4 | Durability Grades 6/7 1.5 million operating cycles | Door mass | Fire resistance pursuant to EN 1906 Annex C | Safety Grades 0/1 3,000 N Tensile load | Corrosion resistance Grade 5 (aluminium and stainless steel) | Security Grades 0–4 | Type of operation A/B/U |

Classification code for FSB ASL® (7, 8 and 8.5 mm)

| 4 | 7 | – | B** | 1 | 5 | 0 | A |
|-------------------------------|--------------------------|-----------|---------------------------------------------------|----------------------|--------------------------------------------------------------------------|------------------------|-------------------------------|
| Category of use Grades 1–4 | Durability Grades 6/7 | Door mass | Fire resistance pursuant to EN 1906 Annex C | Safety Grades 0/1 | Corrosion resistance Grade 5 (aluminium and stainless steel) | Security Grades 0–4 | Type of operation A/B/U |

* for fire door levers pursuant to EN 1634-1 / EN 1906
 ** for fire door levers pursuant to EN 1634-1

Technical information

EN 1906 fittings

1. Category of use

Grade 1

Doors with medium frequency of use by people with a high incentive to exercise care and a small chance of misuse, e. g.. internal residential doors

Grade 2

Doors with medium frequency of use by people with some incentive to exercise care but where there is some chance of misuse, e. g.. internal office doors

Grade 3

Doors with high frequency of use by the public or others with low incentive to exercise care and with a high chance of misuse, e. g.. doors in public administrative buildings

Grade 4

Doors in public places with high frequency of use, which are subject to abuse or at risk of being damaged, e. g.. doors in public toilets or schools, etc.

The fittings are tested on the following aspects in order to allocate the different grades to them:

- Rotational torque strength of the square spindle
- Tensile load
- Free play in neutral position
- Free angular movement

FSB is always in a class of its own: the figures and graphs to the right show just how well our fittings perform against the EN 1906 grading scheme.

Rotational torque strength of the square spindle

The FSB spindle offers greater rotational torque strength with less deformation.

| | |
|------------|----------------------------------|
| Grade 1 | M = 20 Nm |
| Grade 2 | M = 30 Nm |
| Grade 3 | M = 40 Nm |
| Grade 4 | M = 60 Nm |
| FSB | FSB ASL®/AGL® 3/8.5 mm M = 60 Nm |
| | FSB AGL® 9 mm M > 60 Nm |

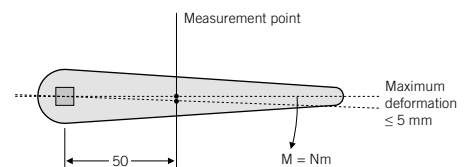

Tensile load

The compact design and durability of the connection elements guarantee the ability to withstand a higher tensile load.

| | |
|------------|----------------------|
| Grade 1 | F = 300 N |
| Grade 2 | F = 500 N |
| Grade 3 | F = 800 N |
| Grade 4 | F = 1,000 N |
| FSB | FSB ASL® F = 2,500 N |
| | FSB AGL® F = 2,500 N |

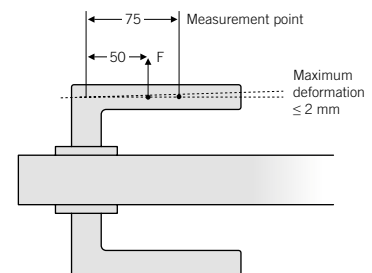

Free play in neutral position

FSB bearing technology ensures a secure hold and does not allow sets to wobble, with a guide bearing depth of 7 mm and handle guide diameter of 18 mm.

| | |
|------------|-------------------|
| Grade 1 | 10 mm |
| Grade 2 | 10 mm |
| Grade 3 | 6 mm |
| Grade 4 | 6 mm |
| FSB | FSB ASL® < 1 mm |
| | FSB AGL® < 0.5 mm |

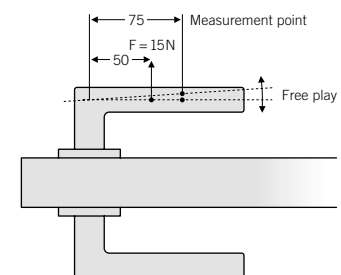

Free angular movement

Thanks to no-play tensioning, the FSB spindle prevents door handles from wobbling.

| | |
|------------|-------------------|
| Grade 1 | 10 mm |
| Grade 2 | 10 mm |
| Grade 3 | 5 mm |
| Grade 4 | 5 mm |
| FSB | FSB ASL® < 1 mm |
| | FSB AGL® < 0.5 mm |

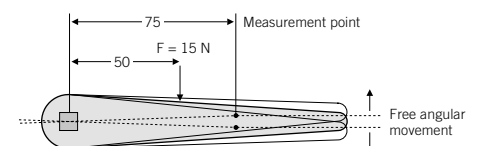

Technical information

EN 1906 fittings

2. Durability

FSB sets far exceed the requirements set for the fatigue test. The force and motion conditions likely to be experienced in the field are recreated on a test rig and simulated in a fatigue test.

| | |
|------------|-------------------------------------------------------------------------|
| Grade 6 | 100,000 operational cycles for medium use |
| Grade 7 | 200,000 operational cycles for high use |
| FSB | FSB ASL® tested for 200,000 cycles (1,000,000 cycles internally at FSB) |
| | FSB AGL® tested for 1,500,000 operational cycles |

3. Door mass

No requirement. This digit describes the door weight.

4. Fire resistance

FSB has conducted fire tests in accordance with EN 1634-1 with different door manufacturers. In these tests, the entire door element is tested, including the fittings.

We also refer to DIN 18273 in this regard, which stipulates that fire safety fittings must bear the Ü mark to indicate fitness for purpose.

5. Safety

There's safe, there's even safer – and then there's FSB. We exceed standard requirements with our spindle connection, turnably fixed bearing and the solid quick-installation system. This digit shows the degree of safety: grade 1 indicates that the fittings meet the required strength values even under extreme loads (e. g., elements which are grasped).

Grade 0 = normal use
Grade 1 = safety application

To be assigned grade 1 here, fittings must be able to withstand loads of 1,500 N or 2,500 N depending on the category of use.

Grade 1 – 4 category of use
(first digit of the classification code)

| | |
|------------|----------------------|
| Grade 1 | F = 1,500 N |
| Grade 2 | F = 1,500 N |
| Grade 3 | F = 2,500 N |
| Grade 4 | F = 2,500 N |
| FSB | FSB ASL® F = 2,500 N |
| | FSB AGL® F > 3,000 N |

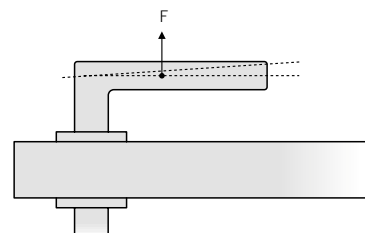

6. Corrosion resistance

This digit describes the defined corrosion resistance. FSB ASL®, FSB AGL® and fire safety sets made of aluminium and stainless steel meet the requirements of grade 5 set out in EN 1906, which is verified with a 480-hour salt spray test.

Grade 0 = no defined corrosion resistance
Grade 1 = mild resistance
Grade 2 = moderate resistance
Grade 3 = high resistance
Grade 4 = very high resistance
Grade 5 = extra high resistance

7. Security

Where 'burglary-resistant fittings' are concerned, FSB offers a special range of fittings for security grades 2 and 4 in many different designs. Naturally our security fittings also meet the other requirements of this standard.

Grade 0 = no burglary resistance
Grade 1 = mild resistance
Grade 2 = moderate resistance
Grade 3 = high resistance
Grade 4 = extra high resistance

8. Type of operation

FSB AGL® and FSB AGL® FS heavy-duty fittings are equipped with a type B positive mechanism and an integrated and defined 0° stop. FSB ASL® fittings have a type A positive mechanism.

A = spring-assisted
B = spring-loaded
U = unsprung





Our product collections focus on facilitating continuity of design throughout a building, right down to the fittings on every door and window. Each door handle has its own individual character and works well both with the hand and with its architectural setting. It is embedded in its coordinated product collection, comprising glass door fittings, door handles for narrow-stile doors, knobs and window handles. (Pictured: FSB 1023 door handle)

Project: Haus M, Anröchte
Architectural firm: Rinsdorf Ströcker
Architekten



- 70 Door handles – added value
- 72 Notes and explanations
- 76 Product collections
- 315 Technical information

Door handles

Added value at a glance

A door handle must be chosen with the architectural setting in mind. That architecture is part of our DNA is illustrated not least by the fact that selected experts in this industry regularly collaborate with FSB and create for many noted FSB product ranges designs that represent their own personal ideal door handles.



Door thicknesses 29–98 mm; others available upon request

Optional short, long or broad backplate and lever/knob or WC sets



Optimal connection of base and cover rose prevents the rose from wobbling

Standard keyways available, including warded lock (WL), profile cylinder (PC), Chubb round cylinder (CH-RC) or blank rose

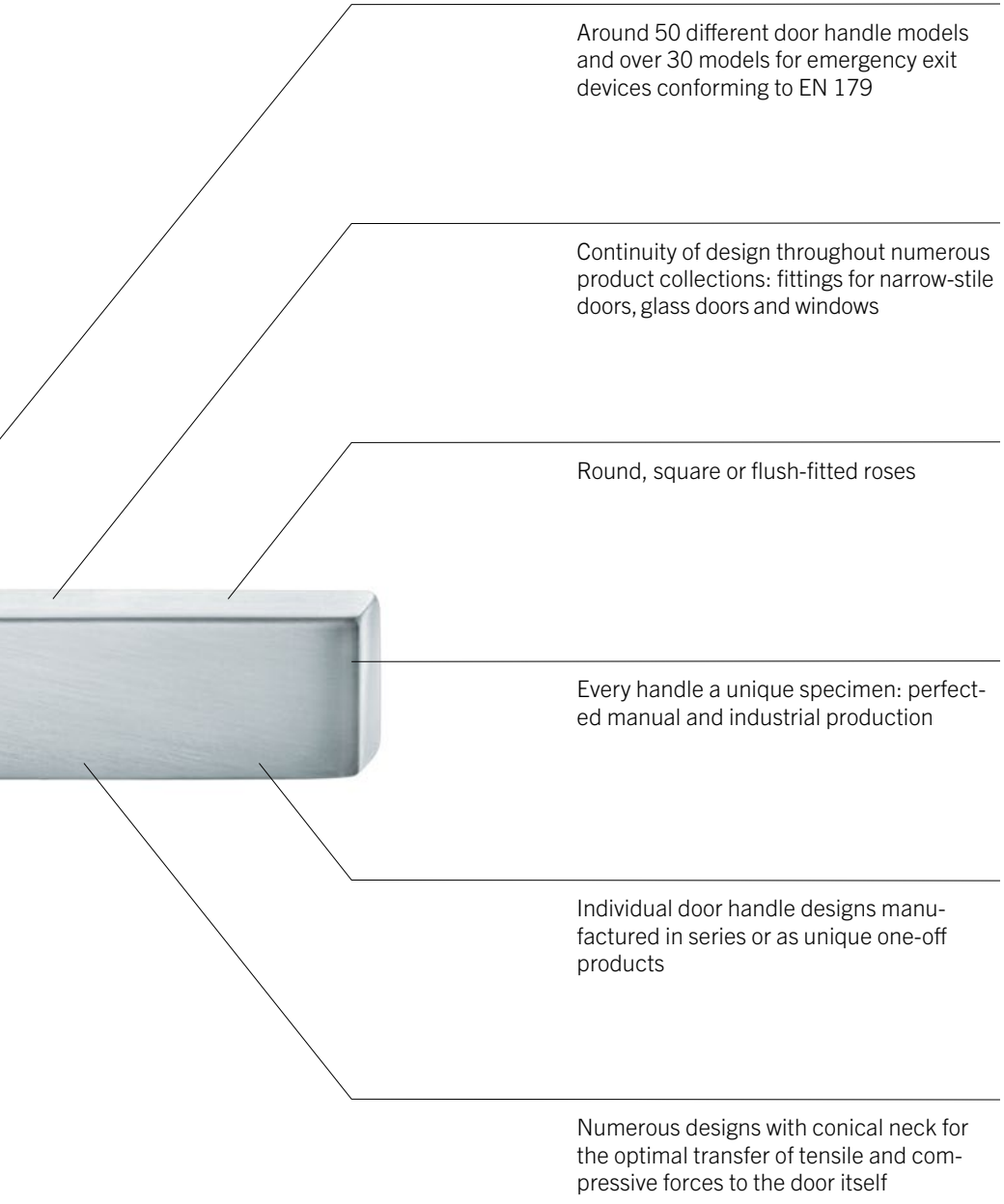

Discreet rose heights, small radii, neat edges

Product collections

Notes and explanations

With over 50 designs, around 20 materials and finishes, and perfectly coordinated bearing technology, the FSB range has countless variants and options for every application area.

Our products are presented in collections in order to make it quick and easy for you to gain an overview of all of the variants in extensive range. The product collections are based on the door handle design or model and allow you to choose consistent configurations of the different fitting types, right down to the desired material. You will also find important technical parameters on the pages that follow.

FSB 1004 | 1134 **OS** **3**

1 **2**

FSB 1004 by David Chipperfield bears the hallmark of the Modernist pioneers. It is underpinned by a clean-lined formal concept that meets all functional requirements giving expression to his formal idea in both public and private spheres.

■ Heavy-duty ■ Aluminium
■ FSB Select ■ Stainless steel
■ Bronze

Design: David Chipperfield

EN 179 model: FSB 1134
Lever handle with return-to-door

Other variants:
– round roses
– oval/angular backplates

1 **4**

90 FSB Manual 14

1 Heavy-duty fittings / EN 179

O = heavy-duty fitting

FSB offers the most extensive range of fittings conforming to EN 179. Product collections that stand out for their continuity of design and suitability for commercial buildings and that include hardware components that conform to EN 179 (e.g. due to the FSB AGL® bearing, fire safety and emergency exit variants, and handles for narrow-stile doors) are marked with **O**.

One stipulation of EN 179 is that the end of the grip section of the door handle must be angled toward the door (lever handle with return-to-door). A number of FSB models are available both with and without a return-to-door, which is determined in the product code by a corresponding product group and/or different model numbers.

The return-to-door is marked in grey in the dimensioned drawings. Further information on EN 179 and panic hardware can be found on page 604 ff.

2 Exclusive FSB Select models

S = FSB Select

FSB has a long tradition of working with renowned designers and architects from all over the world to develop exclusive products that are only available from FSB. These one-of-a-kind FSB Select designs are marked with **S**.

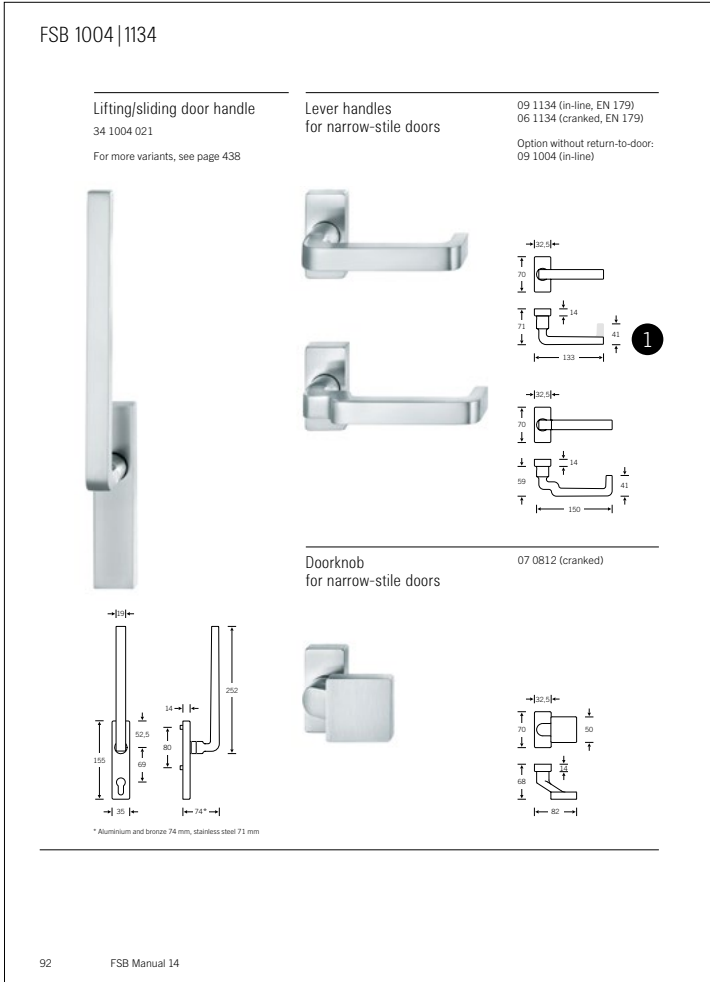

Composition of FSB product codes

FSB product codes go beyond just indicating the hardware types and are based on the model numbers of the door handles. Each product collection ends with a double-page overview of the most common variants with their respective product codes.

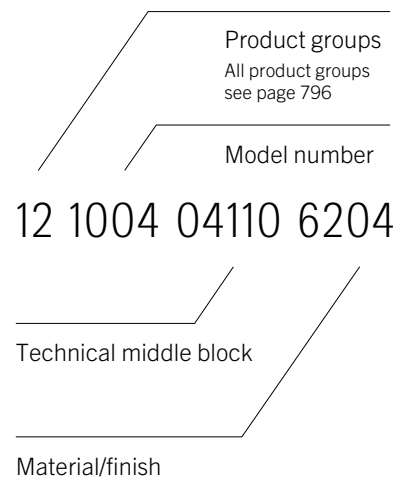

4

3 Materials

We only use metals of the highest quality. The material identifier indicates the metals in which the product in question is available (choice of material may be limited depending on the variant).

- Stainless steel
brushed satin matt, polished or
PVD-coated
- Aluminium
anodised or powder-coated
- Bronze
light or dark, patinated and waxed

4 Product configuration

With a few exceptions, we deliver the FSB product collections both on round and angular roses and backplates as a complete set. In the case of the WC variants of heavy-duty fittings (product groups 72, 76, 79; see following page), FSB delivers the WC roses with an emergency release as standard. Further information can be found in the technical information on page 316.

The new **FSB kit** opens up even broader and completely customisable possibilities of product configuration with individual parts. Discover more on page 318 ff.

Product collections

Notes and explanations

FSB 1004 | 1134

Lever/lever sets

Broad backplate sets available upon request; for flush-fitted roses, see page 532 f.

| | | |
|--|----------------------------------------------------------------------------------------------------------------------------------------------------------------------------------------------------------------------------------------------------------------------------|---------------------------------------------------------------------------------------------------------------------------------------------------------------------------------------------------------------------------------|
| | <ul style="list-style-type: none"> 12 1004 041 (N) 72 1004 641 (R) 76 1004 639 (R) 79 1134 639 (R) | <ul style="list-style-type: none"> 12 1004 049 (prv) 72 1004 642 (L) 76 1004 640 (L) 79 1134 640 (L) |
| | 15 1004 013 (N) | |
| | <ul style="list-style-type: none"> 12 1004 001 (N) 72 1004 601 (R) 76 1004 601 (R) 79 1134 601 (R) | <ul style="list-style-type: none"> 72 1004 602 (L) 76 1004 602 (L) 79 1134 602 (L) |
| | <ul style="list-style-type: none"> 12 1004 021 (N) 72 1004 621 (R) 76 1004 621 (R) 79 1134 621 (R) | <ul style="list-style-type: none"> 72 1004 622 (L) 76 1004 622 (L) 79 1134 622 (L) |
| | <ul style="list-style-type: none"> 13 4220 041 (R) with 10 1004 00500 (N) 13 4220 042 (R) with 12 1004 041 (N) 13 4220 042 (R) with 72 1004 641 (R) 13 4220 090° with 76 1004 639 (R) 13 4220 090° with 79 1134 939 (N) | <ul style="list-style-type: none"> 13 4220 051 (L) with 10 1004 00500 (N) 13 4220 052 (L) with 12 1004 041 (N) 13 4220 052 (L) with 72 1004 642 (L) 13 4220 090° with 76 1004 640 (L) |

Sets for narrow-stile doors

| | |
|--|---------------------------------------------------------------------------------------------------------------------------------------------------------------------------------------------------------------|
| | <ul style="list-style-type: none"> 09 1004 171 09 1004 172 (refit to ILS possible) 09 1134 172 (refit to ILS possible) |
| | <ul style="list-style-type: none"> 06 1134 071 06 1134 072 06 1134 073 (ILS) |
| | <ul style="list-style-type: none"> 07 0812 229 (fixed; aluminium, stainless steel and bronze) 07 0812 229 (fixed; stainless steel and bronze) 07 0812 429 (fixed; aluminium) |
| | 17 1778 |

Lever/knob sets

Broad backplate sets available upon request; for flush-fitted roses, see page 532 f.

| | | |
|--|-------------------------------------------------------------------------------------------------------------------------------------------------------------------------|---------------------------------------------------------------------------------------------------------------------|
| | <ul style="list-style-type: none"> 12 1004 043 (N) 72 1004 643 (R) 76 1004 641 (R) 79 1134 641 (R) 79 1134 643 (ILS) | <ul style="list-style-type: none"> 72 1004 644 (L) 76 1004 642 (L) 79 1134 642 (L) |
| | <ul style="list-style-type: none"> 12 1004 003 (N) 72 1004 603 (R) 76 1004 603 (R) 79 1134 603 (R) 79 1134 605 (ILS) | <ul style="list-style-type: none"> 72 1004 604 (L) 76 1004 604 (L) 79 1134 604 (L) |
| | <ul style="list-style-type: none"> 12 1004 023 (N) 72 1004 623 (R) 76 1004 623 (R) 79 1134 623 (R) 79 1134 625 (ILS) | <ul style="list-style-type: none"> 72 1004 624 (L) 76 1004 624 (L) 79 1134 624 (L) |

WC sets

Broad backplate sets available upon request; for flush-fitted roses, see page 532 f.

| | | |
|--|--------------------------------------------------------------------------------------------|-----------------|
| | <ul style="list-style-type: none"> 12 1004 045 (N) 72 1004 645 (R) | 72 1004 646 (L) |
| | 15 1004 019 (N) | |
| | <ul style="list-style-type: none"> 12 1004 005 (N) 72 1004 605 (R) | 72 1004 606 (L) |
| | <ul style="list-style-type: none"> 12 1004 025 (N) 72 1004 625 (R) | 72 1004 626 (L) |

Window handles

| | |
|--|--------------------------------------------------------------------------------------------------------------------------------------------------------------------------------------------------------------------------------------------------------------------------------------------------------------------------------------------------------------------------------------------------------------------------------------------------------------------------------------|
| | <ul style="list-style-type: none"> 34 1004 09032 (rose 27 x 62 x 10) 34 1004 09040 (rose 32.5 x 70 x 10) 34 1004 09036 (rose 25.5 x 60.5 flush-fitted) 34 1004 180 (lock adaptor RC 1-6) 34 1004 086 (lock adaptor with push-button RC 1-6) 34 1004 711 (plug-in handle for timber/metal profiles, Ø 30) 34 1004 751 (plug-in handle for PVC profiles, Ø 30) 34 1004 021 (lifting/sliding door handle) |
|--|--------------------------------------------------------------------------------------------------------------------------------------------------------------------------------------------------------------------------------------------------------------------------------------------------------------------------------------------------------------------------------------------------------------------------------------------------------------------------------------|

6

N = non-handed
 prv = lever handle with privacy function
 R = DIN RH, opening inwards
 L = DIN LH, opening inwards
 ILS = inactive-leaf set

Female handles
 Plug-in handle for doors
 FSB ASL®

FSB AGL®
 FS heavy-duty fitting
 EN 179 heavy-duty fitting

For bearings, see page 40 ff.

94 FSB Manual 14

fsb.de/catalogue 95

6 Variants/bearing technology

Each product collection ends with a double-page overview of the most common variants with their respective product codes.

Whether for doors in private residences or high-traffic heavy-duty commercial properties, FSB offers a perfectly coordinated base. The pictograms are explained here on this page and at the bottom of the relevant pages on the right.

Detailed information about the bearings can be found on page 50 ff.

Female handles without roses (product group 10)

Plug-in handle for doors with minimalist handle rose (product group 15)

FSB ASL®, fitting for all types of building, fire resistance in accordance with EN 1634-1 (product group 12)

FSB AGL®, heavy-duty fitting for medium to heavy doors and high-traffic doors (product group 72)

FS heavy-duty fitting, fire safety variant (FS) conforming to DIN 18273 / EN 1634 (product group 76)

EN 179 heavy-duty fitting for fire safety variants (FS) of emergency exit devices conforming to EN 179 (product group 79)

Handing details

Doors can be hung to open to the right or left. Whether a door is left or right-handed depends on where the hinges are located and the direction in which the door opens. When ordering FSB AGL®, lever/knob or broad backplate sets, 'DIN LH' or 'DIN RH' and 'opening inwards' or 'opening outwards' must be specified.

DIN LH,
opening
inwards

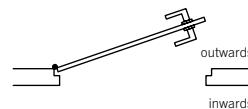
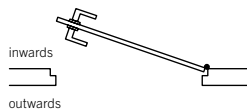

DIN RH,
opening
outwards

DIN RH,
opening
inwards

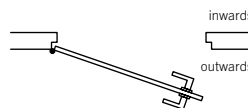
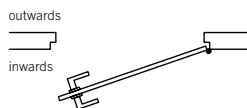

DIN LH,
opening
outwards

Lever/lever sets for fire doors and smoke control doors

The DIN 18273 standard currently in force dates from December 1997 and lays down the requirements and test methods for fire safety fittings. These are regulated building products included in Germany's Building Rules List A under serial no. 6.17. Their fitness for purpose must be verified by a certificate of compliance issued by a recognised certification body. The Ü mark indicating compliance in this regard is provided with every fire safety set.



FSB has the largest range of this kind on the market, with more than 50 door handle models along with roses and backplates, all certified and subject to ongoing monitoring by the Materials Testing Office (MPA) in Dortmund.

It is inadmissible to piece together fire safety sets out of random combinations of parts by any one manufacturer or to mix components of fire safety and smoke control sets from more than one manufacturer. FSB advises heeding the statements and recommendations made by the lock and fittings industries in this respect.

Standard ÖNORM B 3859 is relevant for the Austrian market. All fittings with FSB ASL® or FSB AGL® as well as our security fittings are available with a stepped spindle from 8 to 8.5 mm. They meet the requirements of classification up to EI2-90-C as defined in DIN EN 13501-2 and are permissible in fire protection closures of these classes.

Door handles complying with German accident prevention regulations

Section 11(1) of the regulations of the German Social Accident Insurance (DGUV), 'Fixtures and fittings', stipulates that, in 'areas of occupancy' (these being areas in schools and nursery schools that are 'intended to be accessible to children'), 'edges, corners and hooks on fixtures and fittings [...], up to a height of 2 m from floor level, are to be so designed or made safe that the risk of injury [to the children] is avoided.'

Injury avoidance is to be ensured by means of a minimum radius of 2 mm or by chamfering all corners and edges – and this also applies to door fittings. As would seem natural, only return-to-door models conforming to EN 179 are used, even if they are not explicitly specified. Doors and windows are given special consideration in Section 10 of the DGUV regulations, but their fittings are not. Insurance companies and building supervisory authorities accordingly do not issue certificates for specific models of door handle.

However, our experience over more than 30 years of work on buildings for schools and nursery schools shows that the following FSB models are approved across Germany:

- | | | | |
|--|---------------------|--|--------------------|
| | ..1053 Page 604 | | ..1160 Page 605 |
| | 79 1117 Page 618 | | ..1232 Page 605 |
| | ..1045 Page 604 | | ..1245 Page 605 |
| | ..1070 Page 604 | | ..1268 Page 605 |
| | ..1119 Page 604 | | ..1286 Page 605 |
| | ..1146 Page 605 | | |

Product collections

Overview

1001 **OS** ■ ■ ■ ■ ■
Page 80 ff.



1003 ■ ■ ■ ■ ■
Page 86 ff.



1004 **OS** ■ ■ ■ ■ ■ ■ ■ ■ ■ ■ ■
Page 90 ff.



1005 ■ ■ ■ ■ ■
Page 96 ff.



1015 ■ ■ ■ ■ ■ ■ ■ ■ ■ ■ ■
Page 102 ff.



1016 ■ ■ ■ ■ ■ ■ ■ ■ ■ ■ ■
Page 108 ff.



1021 ■ ■ ■ ■ ■ ■ ■ ■ ■ ■ ■
Page 114 ff.



1023 ■ ■ ■ ■ ■ ■ ■ ■ ■ ■ ■
Page 118 ff.



1035 ■ ■ ■ ■ ■ ■ ■ ■ ■ ■ ■
Page 124 ff.



1045 ■ ■ ■ ■ ■ ■ ■ ■ ■ ■ ■
Page 130 ff.



1051 ■ ■ ■ ■ ■ ■ ■ ■ ■ ■ ■
Page 136 ff.



1058 ■ ■ ■ ■ ■ ■ ■ ■ ■ ■ ■
Page 140 ff.



1070 **O**
Page 144 ff.



1075
Page 150 ff.



1076 **O**
Page 154 ff.



1078 **OS**
Page 160 ff.



1093 **OS**
Page 166 ff.



1102 **S**
Page 172 ff.



1106 **OS**
Page 178 ff.



1107 **O**
Page 184 ff.



1108 **O**
Page 190 ff.



1119 **O**
Page 196 ff.



1135 **S**
Page 202 ff.



1144 **S**
Page 206 ff.



Product collections

Overview

1146 **O** ■ ■ ■
Page 212 ff.



1147 **O** ■ ■ ■
Page 218 ff.



1159 **OS** ■ ■ ■
Page 224 ff.



1160 **O** ■ ■ ■
Page 230 ff.



1163 **OS** ■ ■ ■ ■
Page 236 ff.



1176 ■ ■ ■
Page 242 ff.



1183 **OS** ■ ■ ■
Page 246 ff.



1226 **S** ■ ■ ■
Page 252 ff.



1232 **O** ■ ■ ■
Page 256 ff.



1241 **S** ■ ■ ■
Page 262 ff.



1242 **OS** ■ ■ ■ ■
Page 266 ff.



1244 **OS** ■ ■ ■ ■
Page 272 ff.



1246 **OS** ■
Page 278 ff.



1251 ■ ■
Page 284 ff.



1254 **OS** ■
Page 288 ff.



1267 **OS** ■ ■ ■
Page 294 ff.



4

1271 **OS** ■ ■
Page 300 ff.



1285 **OS** ■
Page 306 ff.



XXL door handles ■
For more models, see page 616 ff.



Architect Peter Bastian wanted his handle to make a dignified impact on tall, large-format doors despite being pared down to an almost doctrinaire degree. The result is a very neatly designed lever handle that offers the hand plenty of squareness to get hold of.

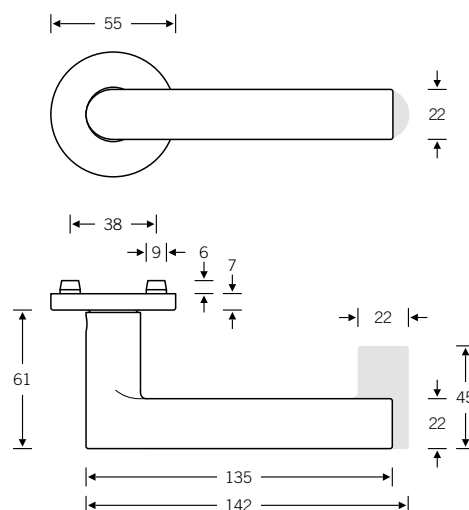

Design: Peter Bastian

Ⓢ EN 179 model: FSB 1002
 Lever handle with return-to-door

Other variants:
 – square roses
 – oval/angular backplates

Lever handle with privacy function

12 1001

Push-button lock, see page 526 ff.

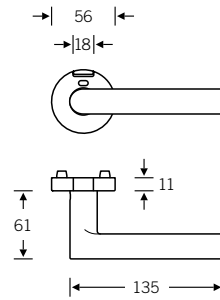

Plug-in handle for doors

15 1001

4

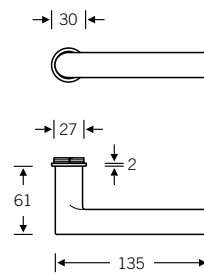

Window handle

Plug-in handle for windows

34 1001

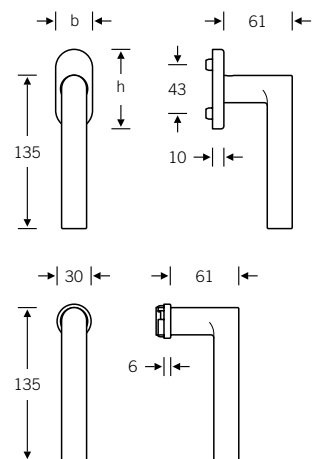

Lever handles for narrow-stile doors

09 1002 (in-line, EN 179)
06 1002 (cranked, EN 179)

Option without return-to-door:
09 1001 (in-line)
06 1001 (cranked)

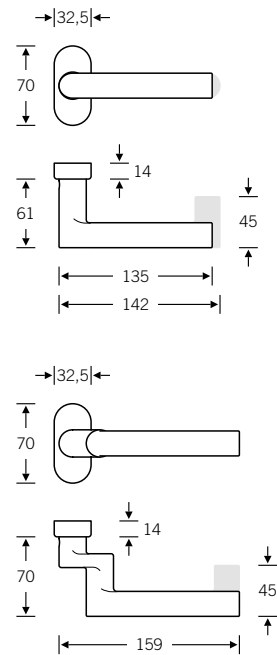

Doorknob for narrow-stile doors

07 0809 (cranked)

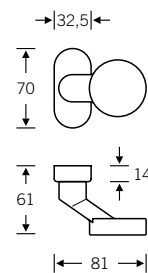

Glass door fitting

13 4220 with 10 1001

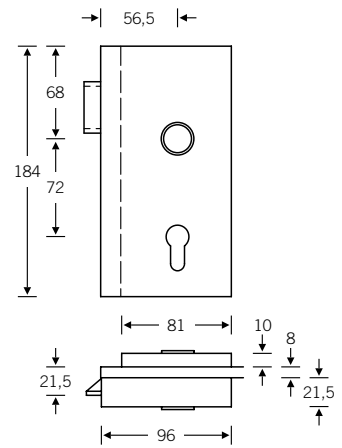

4

Lever/knob sets

Doorknob for flush doors

Knob backplates

Aluminium $\varnothing = 50$

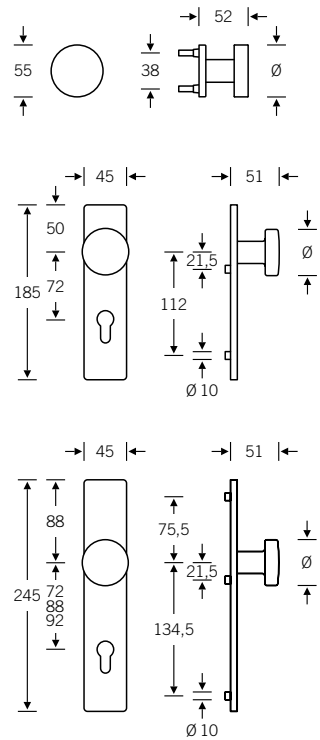

Product codes for the lever/knob sets can be found on the following pages; for individual components, see page 328 ff.

Lever/lever sets

Broad backplate sets available upon request; for flush-fitted roses, see page 536 f.

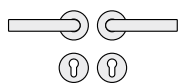

- 12 1001 013 (N)
- 72 1001 613 (R)
- 76 1001 613 (R)
- 79 1002 613 (R)

- 12 1001 047 (prv)
- 72 1001 614 (L)
- 76 1001 614 (L)
- 79 1002 614 (L)

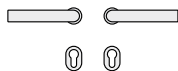

- 15 1001 013 (N)

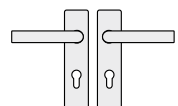

- 12 1001 001 (N)
- 72 1001 601 (R)
- 76 1001 601 (R)
- 79 1002 601 (R)

- 72 1001 602 (L)
- 76 1001 602 (L)
- 79 1002 602 (L)

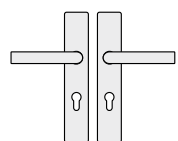

- 12 1001 021 (N)
- 72 1001 621 (R)
- 76 1001 621 (R)
- 79 1002 621 (R)

- 72 1001 622 (L)
- 76 1001 622 (L)
- 79 1002 622 (L)

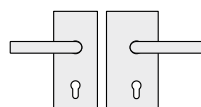

- 13 4220 041 (R) with 10 1001 00500 (N)
- 13 4220 042 (R) with 12 1001 013 (N)
- 13 4220 042 (R) with 72 1001 613 (R)

- 13 4220 051 (L) with 10 1001 00500 (N)
- 13 4220 052 (L) with 12 1001 013 (N)
- 13 4220 052 (L) with 72 1001 614 (L)

Sets for narrow-stile doors

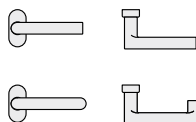

- 09 1001 111
- 09 1001 112 (refit to ILS possible)
- 09 1002 112 (refit to ILS possible)

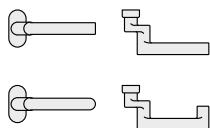

- 06 1001 011
- 06 1001 012
- 06 1002 012
- 06 1001 023 (ILS)
- 06 1002 023 (ILS)



- 07 0809 228 (fixed)
- 07 0809 428 (fixed)



- 17 1757

Lever/knob sets

Broad backplate sets available upon request;
for flush-fitted roses, see page 536 f.

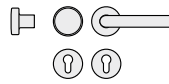

- | | |
|-------------------|-----------------|
| 12 1001 017 (N) | 72 1001 618 (L) |
| 72 1001 617 (R) | 76 1001 618 (L) |
| 76 1001 617 (R) | 79 1002 618 (L) |
| 79 1002 617 (R) | |
| 79 1002 619 (ILS) | |

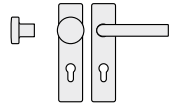

- | | |
|-------------------|-----------------|
| 12 1001 003 (N) | 72 1001 604 (L) |
| 72 1001 603 (R) | 76 1001 604 (L) |
| 76 1001 603 (R) | 79 1002 604 (L) |
| 79 1002 603 (R) | |
| 79 1002 605 (ILS) | |

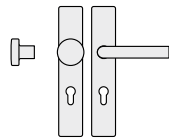

- | | |
|-------------------|-----------------|
| 12 1001 023 (N) | 72 1001 624 (L) |
| 72 1001 623 (R) | 76 1001 624 (L) |
| 76 1001 623 (R) | 79 1002 624 (L) |
| 79 1002 623 (R) | |
| 79 1002 625 (ILS) | |

WC sets

Broad backplate sets available upon request;
for flush-fitted roses, see page 536 f.

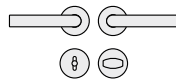

- | | |
|-----------------|-----------------|
| 12 1001 019 (N) | 72 1001 620 (L) |
| 72 1001 619 (R) | |

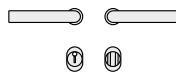

- | |
|-----------------|
| 15 1001 019 (N) |
|-----------------|

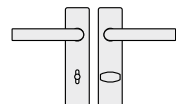

- | | |
|-----------------|-----------------|
| 12 1001 005 (N) | 72 1001 606 (L) |
| 72 1001 605 (R) | |

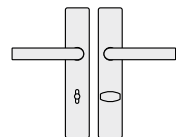

- | | |
|-----------------|-----------------|
| 12 1001 025 (N) | 72 1001 626 (L) |
| 72 1001 625 (R) | |

Window handles



- 34 1001 09030 (rose 27 × 62 × 10)
- 34 1001 09039 (rose 32.5 × 70 × 10)
- 34 1001 09034 (rose 25.5 × 60.5 flush-fitted)
- 34 1001 170 (lock adaptor RC 1–6)
- 34 1001 076 (lock adaptor with push-button RC 1–6)
- 34 1001 711 (plug-in handle for timber/metal profiles, Ø 30)
- 34 1001 751 (plug-in handle for PVC profiles, Ø 30)
- 34 1001 714 (plug-in handle, lock adaptor RC 1–6)
- 34 1001 717 (plug-in handle with push-button RC 1–6)

N = non-handed
 prv = lever handle with privacy function
 R = DIN RH, opening inwards
 L = DIN LH, opening inwards
 ILS = inactive-leaf set

Female handles
 Plug-in handle for doors
 FSB ASL®

FSB AGL®
 FS heavy-duty fitting
 EN 179 heavy-duty fitting

For bearings, see page 52 ff.

The FSB 1003 door handle, which has echoes of a miniature door on its side, is decidedly something of a collector's item. Johannes Potente adopted the underlying visual concept and put it to effect in aluminium and stainless steel.

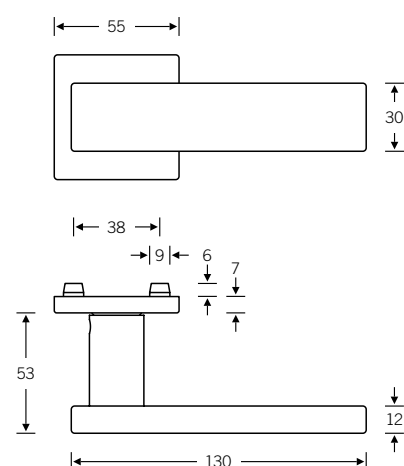

Design: Johannes Potente

Other variants:
 – round roses
 – oval/angular backplates

Lever handle with privacy function

12 1003

Push-button lock, see page 526 ff.

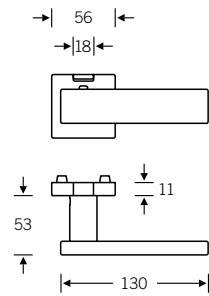

Plug-in handle for doors

15 1003

4

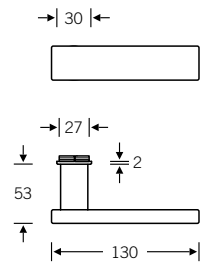

Window handle

Plug-in handle for windows

34 1003

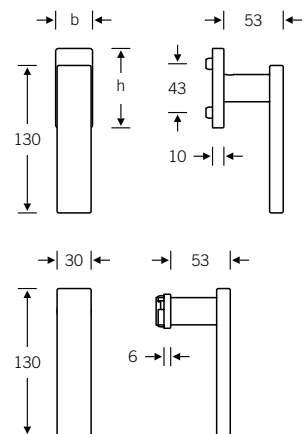

Custom-coordinated lifting/sliding door handle available upon request, see page 10

FSB 1003

Lever/lever sets

Broad backplate sets available upon request;
for flush-fitted roses, see page 386 f.

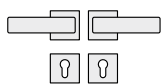

➤ 12 1003 041 (N)

➤ 12 1003 049 (prv)

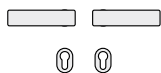

➤ 15 1003 013 (N)

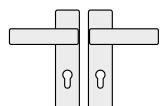

➤ 12 1003 001 (N)

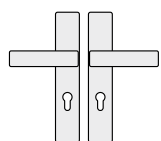

➤ 12 1003 021 (N)

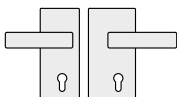

➤ 13 4224 042 (R) with
10 1003 00500 (N)

➤ 13 4224 052 (L) with
10 1003 00500 (N)

Lever/knob sets

Broad backplate sets available upon request;
for associated knobs, see page 328 f.



➤ 12 1003 043 (N)

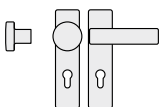

➤ 12 1003 003 (N)

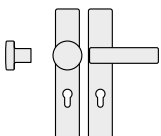

➤ 12 1003 023 (N)

WC sets

Broad backplate sets available upon request;
for flush-fitted roses, see page 386 f.

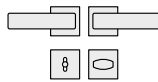

12 1003 045 (N)

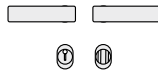

15 1003 019 (N)

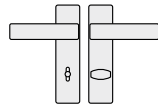

12 1003 005 (N)

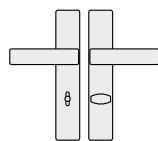

12 1003 025 (N)

Window handles

Custom-coordinated lifting/sliding door
handle available upon request, see page 10



- 34 1003 09032 (rose 27 × 62 × 10)
- 34 1003 09040 (rose 32.5 × 70 × 10)
- 34 1003 09036 (rose 25.5 × 60.5 flush-fitted)
- 34 1003 180 (lock adaptor RC 1–6)
- 34 1003 086 (lock adaptor, with push-button RC 1–6)
- 34 1003 711 (plug-in handle for timber/metal profiles, Ø 30)
- 34 1003 751 (plug-in handle for PVC profiles, Ø 30)

N = non-handed
 prv = lever handle with privacy function
 R = DIN RH, opening inwards
 L = DIN LH, opening inwards
 ILS = inactive-leaf set

↪ Female handles
 ↪ Plug-in handle for doors
 ↪ FSB ASL®

↪ FSB AGL®
 ↪ FS heavy-duty fitting
 ↪ EN 179 heavy-duty fitting

For bearings, see page 52 ff.

FSB 1004 by David Chipperfield bears the hallmark of the Modernist pioneers. It is underpinned by a clean-lined formal concept that meets all functional requirements giving expression to his formal idea in both public and private spheres.

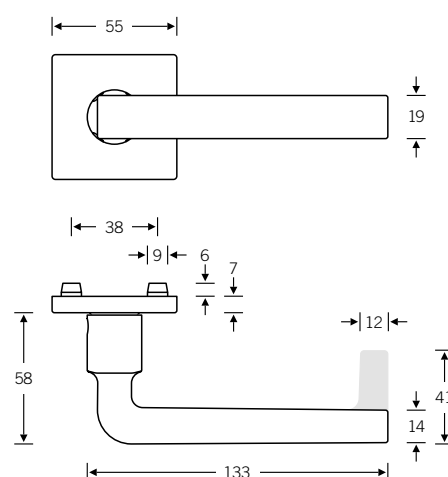

Design: David Chipperfield

 EN 179 model: FSB 1134
Lever handle with return-to-door

Other variants:
– round roses
– oval/angular backplates

Lever handle with privacy function

12 1004

Push-button lock, see page 526 ff.

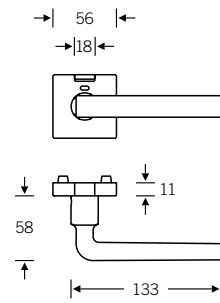

Plug-in handle for doors

15 1004

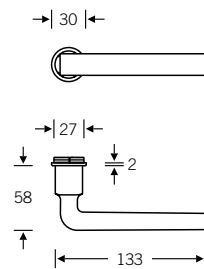

Window handle

Plug-in handle for windows

34 1004

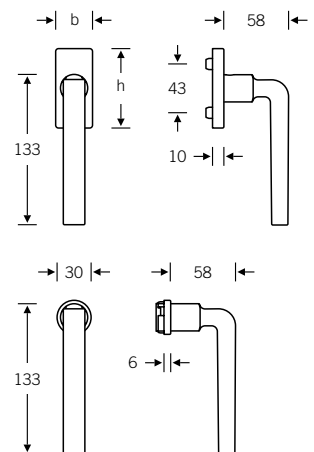

Lifting/sliding door handle

34 1004 021

For more variants, see page 442

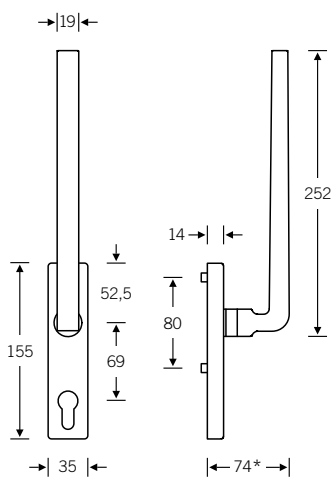

* Aluminium and bronze 74 mm, stainless steel 71 mm

Lever handles for narrow-stile doors



09 1134 (in-line, EN 179)
06 1134 (cranked, EN 179)

Option without return-to-door:
09 1004 (in-line)

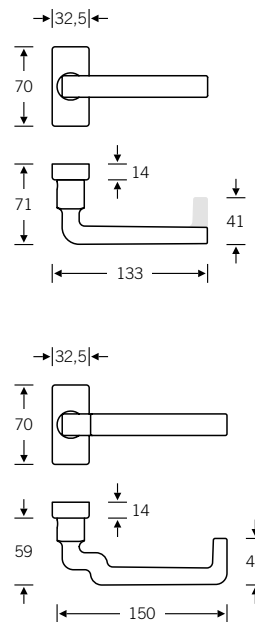

Doorknob for narrow-stile doors



07 0812 (cranked)

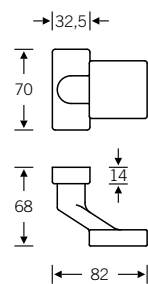

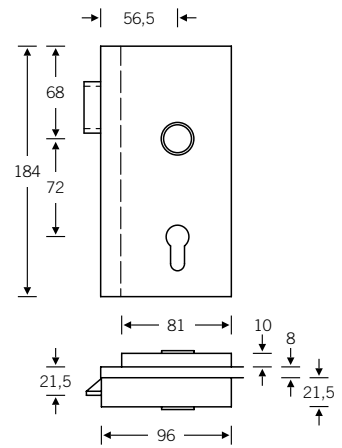

Lever/knob sets

Doorknob for flush doors

Knob backplates

- Aluminium Ø = 50
- Stainless steel Ø = 55
- Bronze Ø = 50

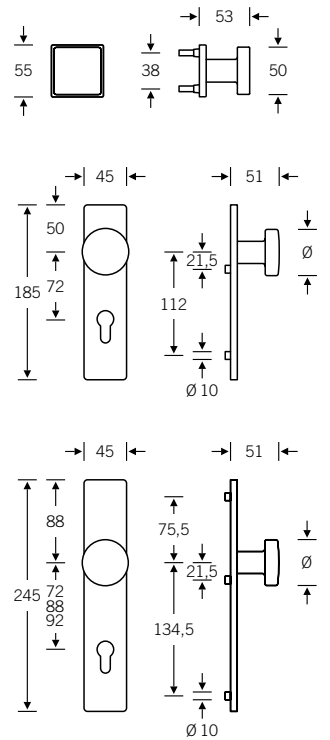

Product codes for the lever/knob sets can be found on the following pages; for individual components, see page 328 ff.

Lever/lever sets

Broad backplate sets available upon request; for flush-fitted roses, see page 536 f.

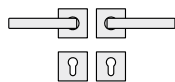

- 🔑 12 1004 041 (N)
- 🔑 72 1004 641 (R)
- 🔑 76 1004 639 (R)
- 🔑 79 1134 639 (R)

- 🔑 12 1004 049 (prv)
- 🔑 72 1004 642 (L)
- 🔑 76 1004 640 (L)
- 🔑 79 1134 640 (L)

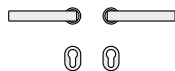

- 🔑 15 1004 013 (N)

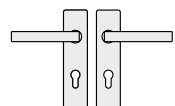

- 🔑 12 1004 001 (N)
- 🔑 72 1004 601 (R)
- 🔑 76 1004 601 (R)
- 🔑 79 1134 601 (R)

- 🔑 72 1004 602 (L)
- 🔑 76 1004 602 (L)
- 🔑 79 1134 602 (L)

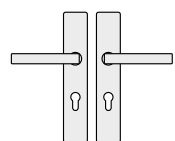

- 🔑 12 1004 021 (N)
- 🔑 72 1004 621 (R)
- 🔑 76 1004 621 (R)
- 🔑 79 1134 621 (R)

- 🔑 72 1004 622 (L)
- 🔑 76 1004 622 (L)
- 🔑 79 1134 622 (L)

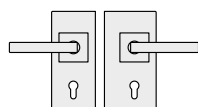

- 🔑 13 4220 041 (R) with 10 1004 00500 (N)
- 🔑 13 4220 042 (R) with 12 1004 041 (N)
- 🔑 13 4220 042 (R) with 72 1004 641 (R)
- 🔑 13 4220 090* with 76 1004 639 (R)
- 🔑 13 4220 090* with 79 1134 939 (N)

- 🔑 13 4220 051 (L) with 10 1004 00500 (N)
- 🔑 13 4220 052 (L) with 12 1004 041 (N)
- 🔑 13 4220 052 (L) with 72 1004 642 (L)
- 🔑 13 4220 090* with 76 1004 640 (L)

Sets for narrow-stile doors

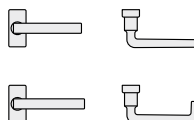

- 🔑 09 1004 171
- 🔑 09 1004 172 (refit to ILS possible)
- 🔑 09 1134 172 (refit to ILS possible)

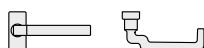

- 🔑 06 1134 071
- 🔑 06 1134 072
- 🔑 06 1134 073 (ILS)



- 07 0812 229 (fixed; aluminium, stainless steel and bronze)
- 🔑 07 0812 229 (fixed; stainless steel and bronze)
- 🔑 07 0812 429 (fixed; aluminium)



- 17 1778

* Fire safety and EN 179 variants available only in stainless steel; for variants, see page 508

Lever/knob sets

Broad backplate sets available upon request;
for flush-fitted roses, see page 536 f.

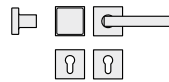

- | | |
|-----------------|-------------------|
| 12 1004 043 (N) | 72 1004 644 (L) |
| 72 1004 643 (R) | 76 1004 642 (L) |
| 76 1004 641 (R) | 79 1134 642 (L) |
| 79 1134 641 (R) | 79 1134 643 (ILS) |

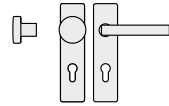

- | | |
|-----------------|-------------------|
| 12 1004 003 (N) | 72 1004 604 (L) |
| 72 1004 603 (R) | 76 1004 604 (L) |
| 76 1004 603 (R) | 79 1134 604 (L) |
| 79 1134 603 (R) | 79 1134 605 (ILS) |

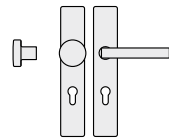

- | | |
|-----------------|-------------------|
| 12 1004 023 (N) | 72 1004 624 (L) |
| 72 1004 623 (R) | 76 1004 624 (L) |
| 76 1004 623 (R) | 79 1134 624 (L) |
| 79 1134 623 (R) | 79 1134 625 (ILS) |

WC sets

Broad backplate sets available upon request;
for flush-fitted roses, see page 536 f.

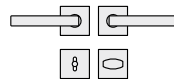

- | | |
|-----------------|-----------------|
| 12 1004 045 (N) | 72 1004 646 (L) |
| 72 1004 645 (R) | |

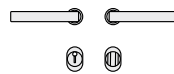

- | |
|-----------------|
| 15 1004 019 (N) |
|-----------------|

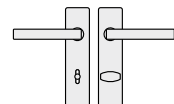

- | | |
|-----------------|-----------------|
| 12 1004 005 (N) | 72 1004 606 (L) |
| 72 1004 605 (R) | |

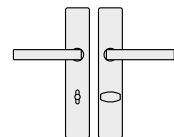

- | | |
|-----------------|-----------------|
| 12 1004 025 (N) | 72 1004 626 (L) |
| 72 1004 625 (R) | |

Window handles

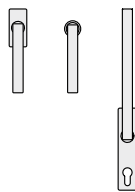

- 34 1004 09032 (rose 27 × 62 × 10)
- 34 1004 09040 (rose 32.5 × 70 × 10)
- 34 1004 09036 (rose 25.5 × 60.5 flush-fitted)
- 34 1004 180 (lock adaptor RC 1–6)
- 34 1004 086 (lock adaptor with push-button RC 1–6)
- 34 1004 711 (plug-in handle for timber/metal profiles, Ø 30)
- 34 1004 751 (plug-in handle for PVC profiles, Ø 30)
- 34 1004 021 (lifting/sliding door handle)

N = non-handed
 prv = lever handle with privacy function
 R = DIN RH, opening inwards
 L = DIN LH, opening inwards
 ILS = inactive-leaf set

Female handles
 Plug-in handle for doors
 FSB ASL®

FSB AGL®
 FS heavy-duty fitting
 EN 179 heavy-duty fitting

For bearings, see page 52 ff.

There are a plethora of wedge-shaped handles around. Almost every company makes its own version of this basic shape. The original design of this lever handle is most probably attributable to Professor Max Burchartz. The FSB 1005 design by Johannes Potente is characterised by its slender proportions.

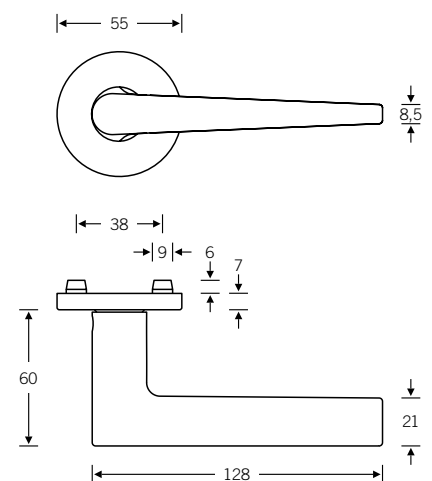

Design: Johannes Potente

Other variants:
 – square roses
 – oval/angular backplates

Lever handle with privacy function

12 1005

Push-button lock, see page 526 ff.

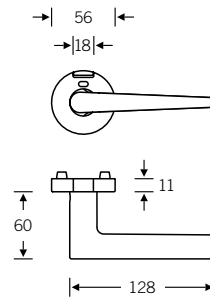

Plug-in handle for doors

15 1005

4

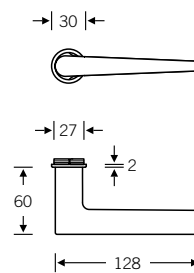

Window handle

Plug-in handle for windows

34 1005

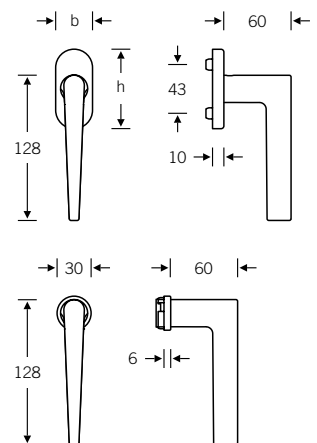

Custom-coordinated lifting/sliding door handle available upon request, see page 10

Lever handles for narrow-stile doors

09 1005 (in-line)

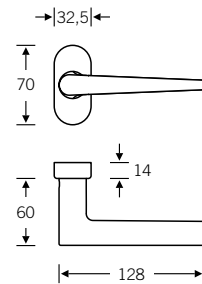

Doorknob for narrow-stile doors

07 0809 (cranked)

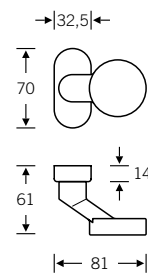

Glass door fitting

13 4220 with 12 1005

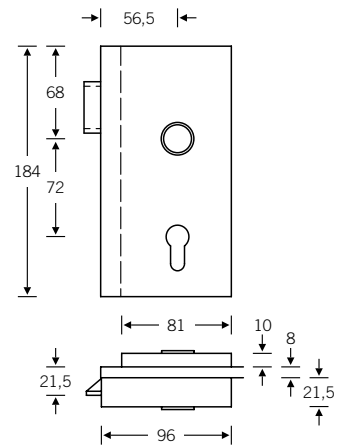

4

Lever/knob sets

Doorknob for flush doors

Knob backplates

- Aluminium $\varnothing = 50$
- Stainless steel $\varnothing = 55$
- Bronze $\varnothing = 50$

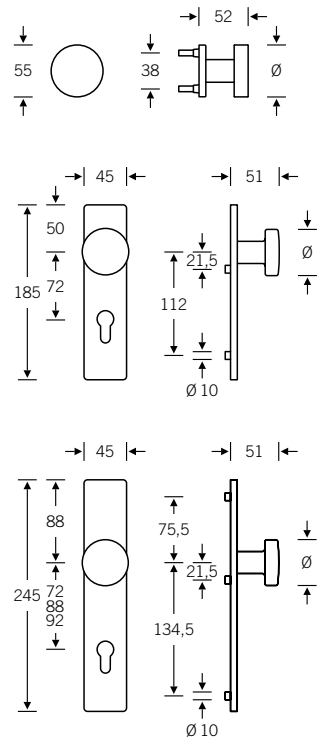

Product codes for the lever/knob sets can be found on the following pages; for individual components, see page 328 ff.

FSB 1005

Lever/lever sets

Broad backplate sets available upon request;
for flush-fitted roses, see page 386 f.

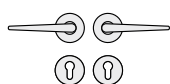

➤ 12 1005 013 (N)

➤ 12 1005 047 (prv)

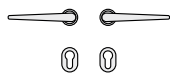

➤ 15 1005 013 (N)

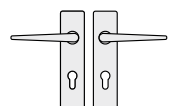

➤ 12 1005 001 (N)

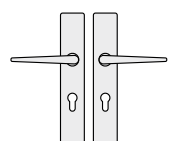

➤ 12 1005 021 (N)

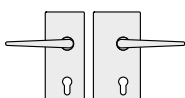

➤ 13 4220 041 (R) with
10 1005 00500 (N)

➤ 13 4220 051 (L) with
10 1005 00500 (N)

➤ 13 4220 042 (R) with
12 1005 013 (N)

➤ 13 4220 052 (L) with
12 1005 013 (N)

Sets for narrow-stile doors



➤ 09 1005 111

➤ 09 1005 112 (refit to ILS possible)



➤ 07 0809 228 (fixed; aluminium and stainless steel)

➤ 07 0809 228 (fixed; stainless steel and bronze)

➤ 07 0809 428 (fixed; aluminium)



17 1757

Lever/knob sets

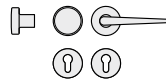

12 1005 017 (N)

Broad backplate sets available upon request

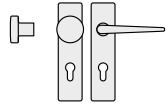

12 1005 003 (N)

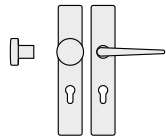

12 1005 023 (N)

WC sets

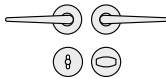

12 1005 019 (N)

Broad backplate sets available upon request;
for flush-fitted roses, see page 386 f.

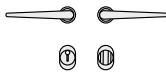

15 1005 019 (N)

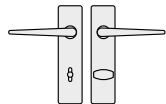

12 1005 005 (N)

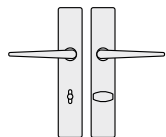

12 1005 025 (N)

Window handles



Custom-coordinated lifting/sliding door
handle available upon request, see page 10

- 34 1005 09030 (rose 27 × 62 × 10)
- 34 1005 09039 (rose 32.5 × 70 × 10)
- 34 1005 09034 (rose 25.5 × 60.5 flush-fitted)
- 34 1005 170 (lock adaptor RC 1–6)
- 34 1005 076 (lock adaptor with push-button RC 1–6)
- 34 1005 711 (plug-in handle for timber/metal profiles, Ø 30)
- 34 1005 751 (plug-in handle for PVC profiles, Ø 30)

N = non-handed
prv = lever handle with privacy function
R = DIN RH, opening inwards
L = DIN LH, opening inwards
ILS = inactive-leaf set

♀ Female handles
♂ Plug-in handle for doors
♂ FSB ASL®

♂ FSB AGL®
♂ FS heavy-duty fitting
♂ EN 179 heavy-duty fitting

For bearings, see page 52 ff.

We suspect that the underlying shape of the FSB 1015 originated in the 1930s, conceived by a company called Wehag. This version by Johannes Potente is a very clean-lined affair that is particularly sought after in the Netherlands.

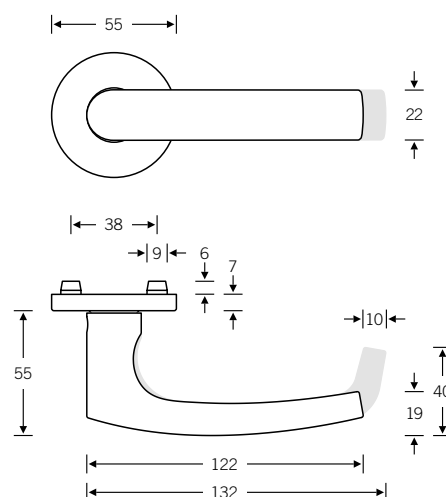

Design: Johannes Potente

 EN 179 model: FSB 1045
 Lever handle with return-to-door

Other variants:
 – square roses
 – oval/angular backplates

Lever handle with privacy function

12 1015

Push-button lock, see page 526 ff.

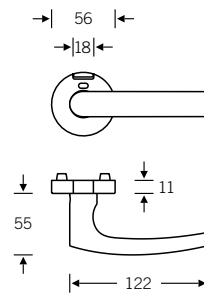

Plug-in handle for doors

15 1015

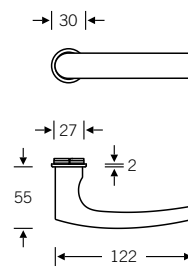

Window handle

Plug-in handle for windows

34 1015

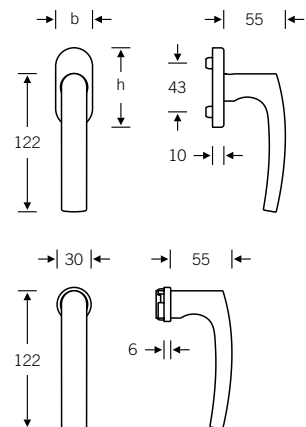

Custom-coordinated lifting/sliding door handle available upon request, see page 10

Lever handles for narrow-stile doors

09 1015 (in-line)
06 1015 (cranked)

Option with return-to-door:
09 1045 (in-line, EN 179)
06 1045 (cranked, EN 179)
See page 132

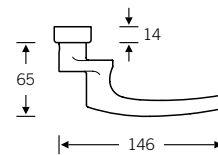
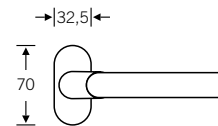
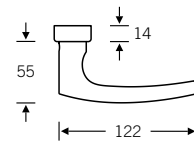
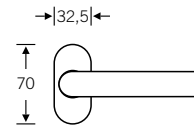

Doorknob for narrow-stile doors

07 0809 (cranked)

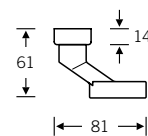
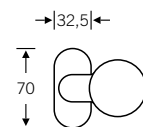

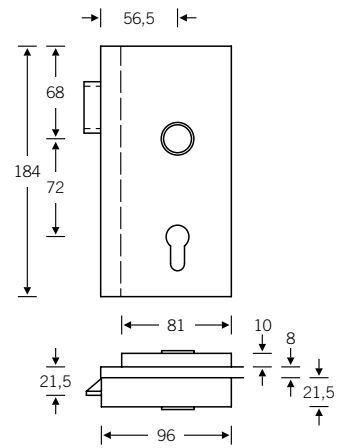

Lever/knob sets

Doorknob for flush doors

Knob backplates

- Aluminium $\varnothing = 50$
- Stainless steel $\varnothing = 55$
- Bronze $\varnothing = 50$

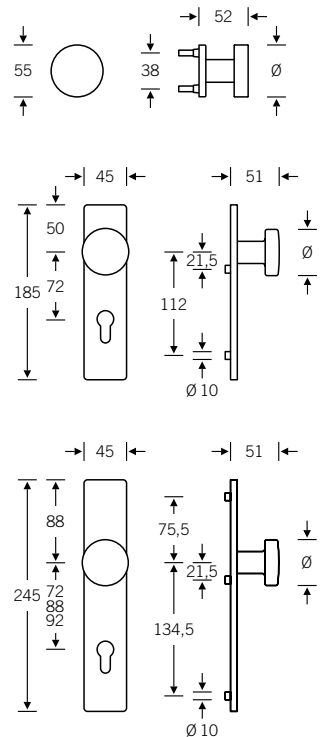

Product codes for the lever/knob sets can be found on the following pages; for individual components, see page 328 ff.

Lever/lever sets

Broad backplate sets available upon request; for flush-fitted roses, see page 536 f.

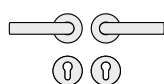

- 12 1015 013 (N)
- 72 1015 613 (R)
- 76 1015 613 (R)
- 79 1045 613 (R)

- 12 1015 047 (prv)
- 72 1015 614 (L)
- 76 1015 614 (L)
- 79 1045 614 (L)

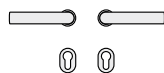

- 15 1015 013 (N)

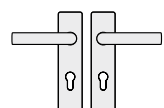

- 12 1015 001 (N)
- 72 1015 601 (R)
- 76 1015 601 (R)
- 79 1045 601 (R)

- 72 1015 602 (L)
- 76 1015 602 (L)
- 79 1045 602 (L)

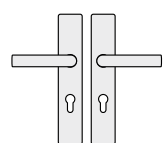

- 12 1015 021 (N)
- 72 1015 621 (R)
- 76 1015 621 (R)
- 79 1045 621 (R)

- 72 1015 622 (L)
- 76 1015 622 (L)
- 79 1045 622 (L)

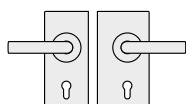

- 13 4220 041 (R) with 10 1015 00500 (N)
- 13 4220 042 (R) with 12 1015 013 (N)
- 13 4220 042 (R) with 72 1015 613 (R)
- 13 4220 090* with 76 1015 613 (R)
- 13 4220 090* with 79 1045 913 (N)

- 13 4220 051 (L) with 10 1015 00500 (N)
- 13 4220 052 (L) with 12 1015 013 (N)
- 13 4220 052 (L) with 72 1015 614 (L)
- 13 4220 090* with 76 1015 614 (L)

Sets for narrow-stile doors

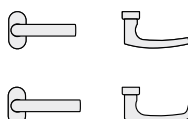

- 09 1015 111
- 09 1015 112 (refit to ILS possible)
- 09 1045 111
- 09 1045 112 (refit to ILS possible)

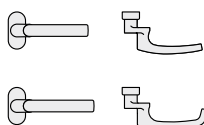

- 06 1015 011
- 06 1015 012
- 06 1045 011
- 06 1045 012
- 06 1015 023 (ILS)
- 06 1045 023 (ILS)



- 07 0809 228 (fixed; aluminium and stainless steel)
- 07 0809 228 (fixed; stainless steel)
- 07 0809 428 (fixed; aluminium)

For set in bronze with knob 07 0846, see page 481



- 17 1757

* Fire safety and EN 179 variants available only in stainless steel; for variants, see page 508

Lever/knob sets

Broad backplate sets available upon request; for flush-fitted roses, see page 536 f.

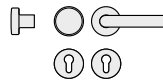

- | | |
|-------------------|-------------------|
| 12 1015 017 (N) | 72 1015 618 (L) |
| 72 1015 617 (R) | 76 1015 618 (L) |
| 76 1015 617 (R) | 79 1045 618 (L) |
| 79 1045 617 (R) | 79 1045 619 (ILS) |
| 79 1045 619 (ILS) | |

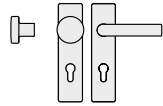

- | | |
|-------------------|-----------------|
| 12 1015 003 (N) | 72 1015 604 (L) |
| 72 1015 603 (R) | 76 1015 604 (L) |
| 76 1015 603 (R) | 79 1045 604 (L) |
| 79 1045 603 (R) | |
| 79 1045 605 (ILS) | |

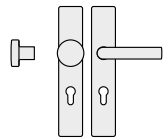

- | | |
|-------------------|-----------------|
| 12 1015 023 (N) | 72 1015 624 (L) |
| 72 1015 623 (R) | 76 1015 624 (L) |
| 76 1015 623 (R) | 79 1045 624 (L) |
| 79 1045 623 (R) | |
| 79 1045 625 (ILS) | |

WC sets

Broad backplate sets available upon request; for flush-fitted roses, see page 536 f.

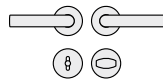

- | | |
|-----------------|-----------------|
| 12 1015 019 (N) | 72 1015 620 (L) |
| 72 1015 619 (R) | |

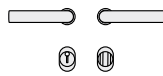

- | |
|-----------------|
| 15 1015 019 (N) |
|-----------------|

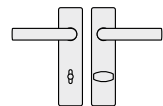

- | | |
|-----------------|-----------------|
| 12 1015 005 (N) | 72 1015 606 (L) |
| 72 1015 605 (R) | |

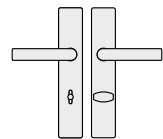

- | | |
|-----------------|-----------------|
| 12 1015 025 (N) | 72 1015 626 (L) |
| 72 1015 625 (R) | |

Window handles

Custom-coordinated lifting/sliding door handle available upon request, see page 10



- 34 1015 09030 (rose 27 × 62 × 10)
- 34 1015 09039 (rose 32.5 × 70 × 10)
- 34 1015 09034 (rose 25.5 × 60.5 flush-fitted)
- 34 1015 170 (lock adaptor RC 1–6)
- 34 1015 076 (lock adaptor with push-button RC 1–6)
- 34 1015 711 (plug-in handle for timber/metal profiles, Ø 30)
- 34 1015 751 (plug-in handle for PVC profiles, Ø 30)

N = non-handed
 prv = lever handle with privacy function
 R = DIN RH, opening inwards
 L = DIN LH, opening inwards
 ILS = inactive-leaf set

Female handles
 Plug-in handle for doors
 FSB ASL®

FSB ASL®
 FS heavy-duty fitting
 EN 179 heavy-duty fitting

For bearings, see page 52 ff.

The 1076 model FSB launched in 1990, a lever handle design with its roots in the 1920s, became the most copied lever handle of the century. The version shown here, the FSB 1016, is a more enclosed counterpart to it.

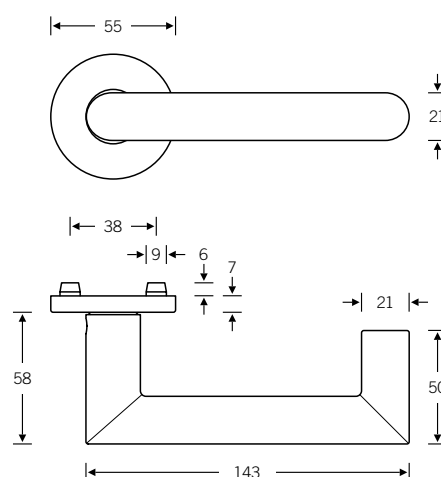

 EN 179 model:
Lever handle with return-to-door

Other variants:
 – square roses
 – oval/angular backplates

Lever handle with privacy function

12 1016

Push-button lock, see page 526 ff.

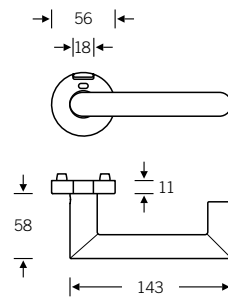

Plug-in handle for doors

15 1016

4

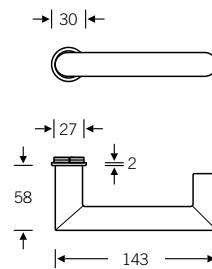

Window handle

Plug-in handle for windows

34 1076

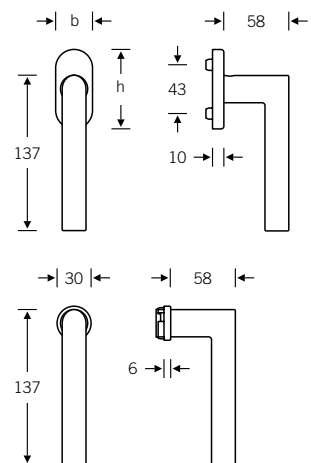

Lifting/sliding door handle

34 1016 011

For more variants, see page 443
For parallel slide/tilt fitting, see page 439

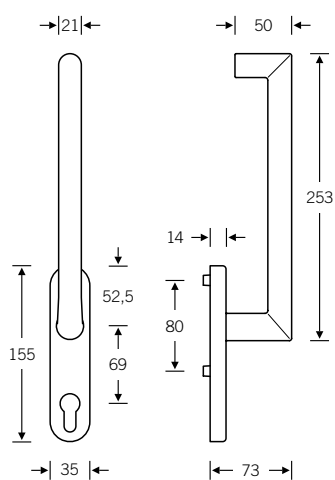

Lever handles
for narrow-stile doors



09 1016 (in-line, EN 179)
06 1016 (cranked, EN 179)

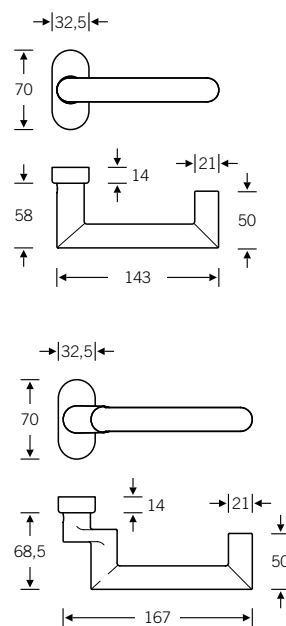

Doorknob
for narrow-stile doors

07 0809 (cranked)

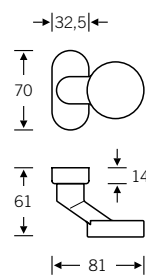

Glass door fitting

13 4220 with 72 1016

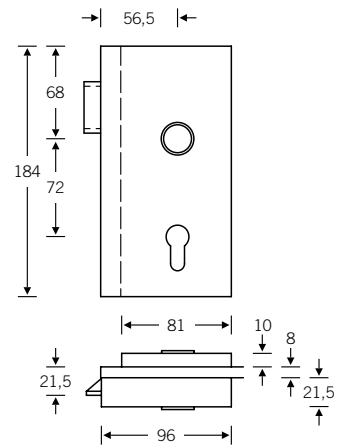

Lever/knob sets

Doorknob for flush doors

Knob backplates

Aluminium $\varnothing = 50$
 Stainless steel $\varnothing = 55$
 Bronze $\varnothing = 50$

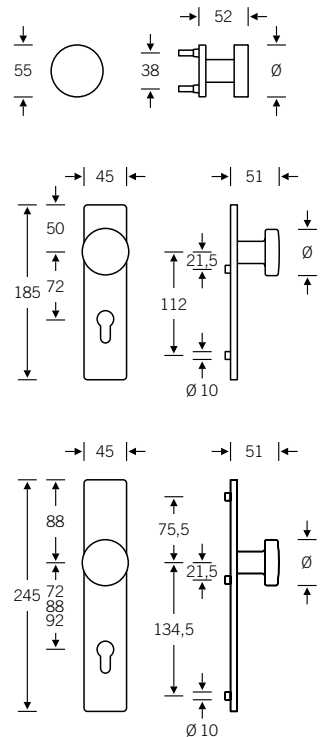

Product codes for the lever/knob sets can be found on the following pages; for individual components, see page 328 ff.

Lever/lever sets

Broad backplate sets available upon request;
for flush-fitted roses, see page 386 f.

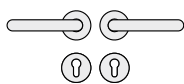

12 1016 013 (N)
 72 1016 613 (R)
 79 1016 613 (R)

12 1016 047 (prv)
 72 1016 614 (L)
 79 1016 614 (L)

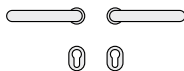

15 1016 013 (N)

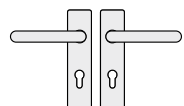

12 1016 001 (N)
 72 1016 601 (R)
 79 1016 601 (R)

72 1016 602 (L)
 79 1016 602 (L)

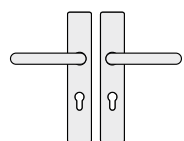

12 1016 021 (N)
 72 1016 621 (R)
 79 1016 621 (R)

72 1016 622 (L)
 79 1016 622 (L)

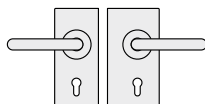

13 4220 041 (R) with
 10 1016 00500 (N)
 13 4220 042 (R) with
 12 1016 013 (N)
 13 4220 042 (R) with
 72 1016 613 (R)*
 13 4220 090* with
 79 1016 913 (N)

13 4220 051 (L) with
 10 1016 00500 (N)
 13 4220 052 (L) with
 12 1016 013 (N)
 13 4220 052 (L) with
 72 1016 614 (L)*

Sets for narrow-stile doors



09 1016 111
 09 1016 112 (refit to ILS possible)

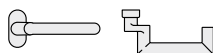

06 1016 011
 06 1016 012
 06 1016 023 (ILS)



07 0809 228 (fixed; aluminium and stainless steel)
 07 0809 228 (fixed; stainless steel)
 07 0809 428 (fixed; aluminium)



17 1757

* Fire safety and EN 179 variants available
only in stainless steel;
for variants, see page 508

Lever/knob sets

Broad backplate sets available upon request

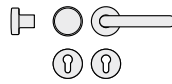

- 12 1016 017 (N)
- 72 1016 617 (R)
- 79 1016 617 (R)
- 79 1016 619 (ILS)
- 72 1016 618 (L)
- 79 1016 618 (L)

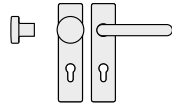

- 12 1016 003 (N)
- 72 1016 603 (R)
- 79 1016 603 (R)
- 79 1016 605 (ILS)
- 72 1016 604 (L)
- 79 1016 604 (L)

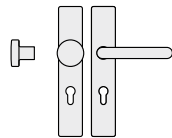

- 12 1016 023 (N)
- 72 1016 623 (R)
- 79 1016 623 (R)
- 79 1016 625 (ILS)
- 72 1016 624 (L)
- 79 1016 624 (L)

WC sets

Broad backplate sets available upon request;
for flush-fitted roses, see page 386 f.

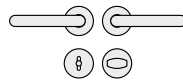

- 12 1016 019 (N)
- 72 1016 619 (R)
- 72 1016 620 (L)

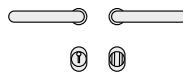

- 15 1016 019 (N)

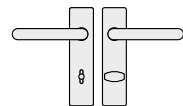

- 12 1016 005 (N)
- 72 1016 605 (R)
- 72 1016 606 (L)

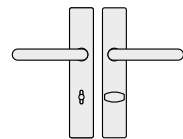

- 12 1016 025 (N)
- 72 1016 625 (R)
- 72 1016 626 (L)

Window handles

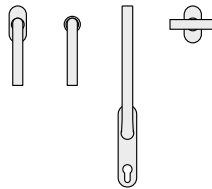

- 34 1076 09030 (rose 27 × 62 × 10)
- 34 1076 09039 (rose 32.5 × 70 × 10)
- 34 1076 09034 (rose 25.5 × 60.5 flush-fitted)
- 34 1076 170 (lock adaptor RC 1–6)
- 34 1076 076 (lock adaptor with push-button RC 1–6)
- 34 1076 711 (plug-in handle, timber/metal profiles, Ø 30)
- 34 1076 751 (plug-in handle for PVC profiles, Ø 30)
- 34 1076 714 (plug-in handle, lock adaptor RC 1–6)
- 34 1076 717 (plug-in handle with push-button RC 1–6)
- 34 3403 (tee handle for window)
- 34 1016 011 (lifting/sliding door handle)

N = non-handed
 prv = lever handle with privacy function
 R = DIN RH, opening inwards
 L = DIN LH, opening inwards
 ILS = inactive-leaf set

Female handles
 Plug-in handle for doors
 FSB ASL®

FSB AGL®
 FS heavy-duty fitting
 EN 179 heavy-duty fitting

For bearings, see page 52 ff.

Catalogue No. 6 published by the S. A. Loevy bronzeware factory in the 1930s contained a variety of door fittings by Rachlis, Grenander, Behrens, Wagenfeld and Paul, where a circular neck was combined with a flat grip section. The FSB 1021 is an equally timeless variation on this design principle.

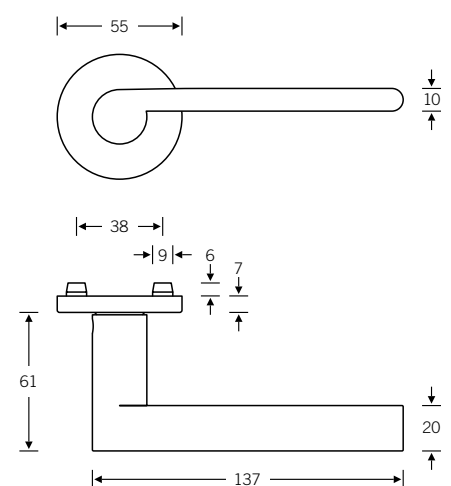

Pictured: right-hand model

Other variants:
 – square roses
 – oval/angular backplates

Lever handle with privacy function

12 1021

Push-button lock, see page 526 ff.

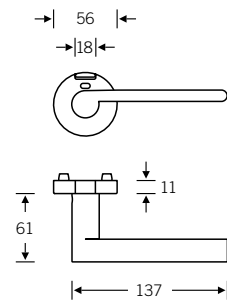

Plug-in handle for doors

15 1021

4

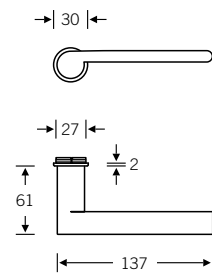

Window handle

34 1021

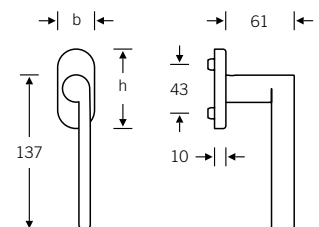

FSB 1021

Lever/lever sets

Broad backplate sets available upon request;
for flush-fitted roses, see page 386 f.

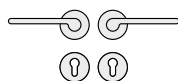

➤ 12 1021 013 (N)

➤ 12 1021 047 (prv)

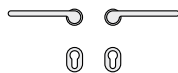

➤ 15 1021 013 (N)

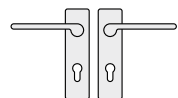

➤ 12 1021 001 (N)

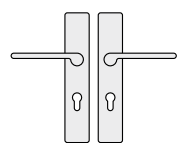

➤ 12 1021 021 (N)

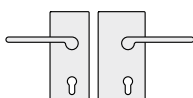

➤ 13 4224 042 (R) with
10 1021 00500 (N)

➤ 13 4224 052 (L) with
10 1021 00500 (N)

Lever/knob sets

Broad backplate sets available upon request;
for associated knobs, see page 328 f.

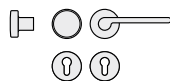

➤ 12 1021 017 (R)

➤ 12 1021 018 (L)

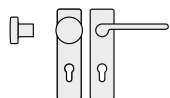

➤ 12 1021 003 (R)

➤ 12 1021 004 (L)

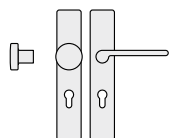

➤ 12 1021 023 (R)

➤ 12 1021 024 (L)

WC sets

Broad backplate sets available upon request;
for flush-fitted roses, see page 386 f.

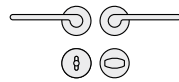

 12 1021 019 (N)

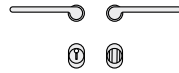

 15 1021 019 (N)

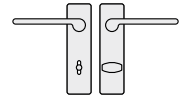

 12 1021 005 (N)

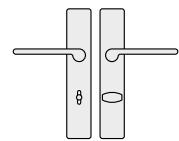



 12 1021 025 (N)



Window handles



34 1021 49039 (R) | 59039 (L) (rose 32.5×70×10)
34 1021 470 (R) | 570 (L) (lock adaptor RC 1–6)
34 1021 476 (R) | 576 (L) (lock adaptor with push-button RC 1–6)

N = non-handed
prv = lever handle with privacy function
R = DIN RH, opening inwards
L = DIN LH, opening inwards
ILS = inactive-leaf set

 Female handles
 Plug-in handle for doors
 FSB ASL®

 FSB AGL®
 FS heavy-duty fitting
 EN 179 heavy-duty fitting

For bearings, see page 52 ff.

In the 1950s, the Swiss architect, sculptor and designer Max Bill got together with Ernst Moeckel to fashion a door handle that made design history as the 'Ulm handle'. It, in turn, prompted Johannes Potente to produce the FSB 1023, which has long served as an alternative to the common U-shaped models.

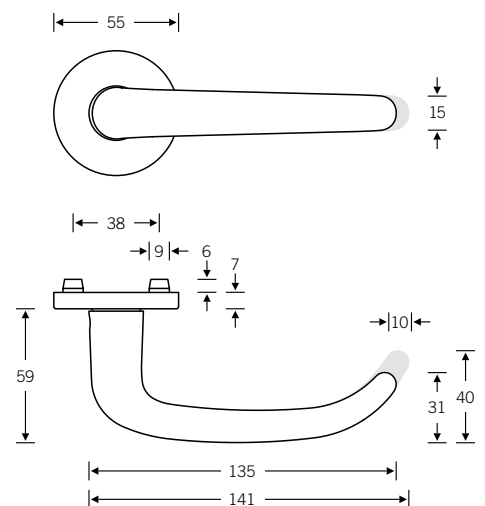

Design: Johannes Potente

 EN 179 model: FSB 1053
 Lever handle with return-to-door

Other variants:
 – square roses
 – oval/angular backplates

Lever handle with privacy function

12 1023

Push-button lock, see page 526 ff.

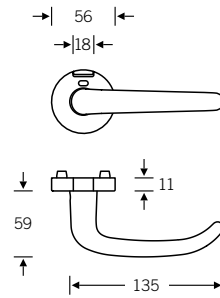

Plug-in handle for doors

15 1023

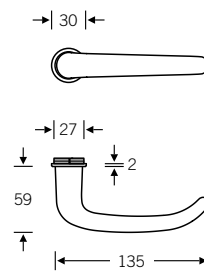

Window handle

Plug-in handle for windows

34 1023

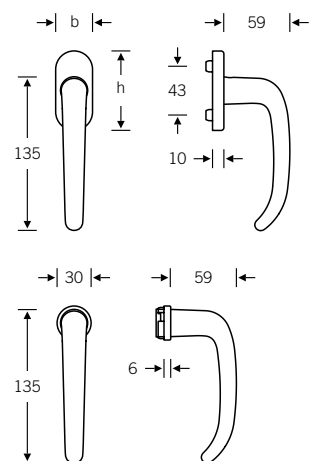

Custom-coordinated lifting/sliding door handle available upon request, see page 10

Lever handles for narrow-stile doors

09 1053 (in-line, EN 179)
06 1053 (cranked, EN 179)

Option without return-to-door:
09 1023 (in-line)
06 1023 (cranked)

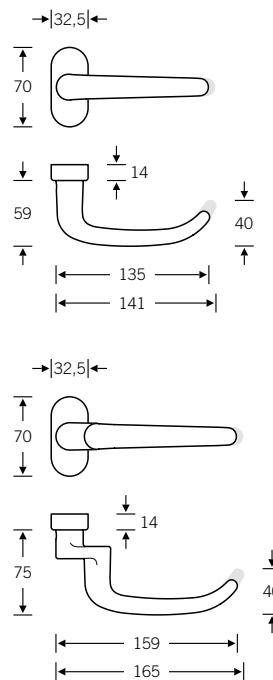

Doorknob for narrow-stile doors

07 0846 (cranked)

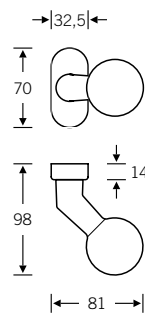

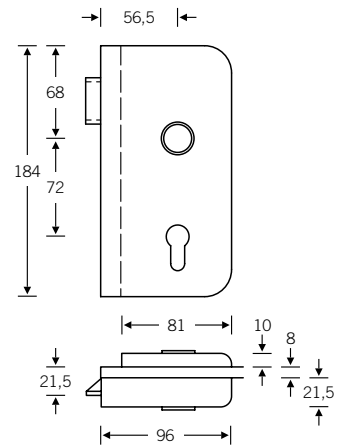

Lever/knob sets

Doorknob for flush doors

Knob backplates

- Aluminium X = 77 mm
- Stainless steel X = 73 mm
- Bronze X = 72 mm

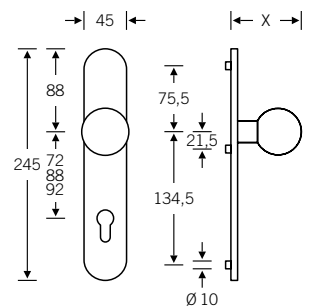
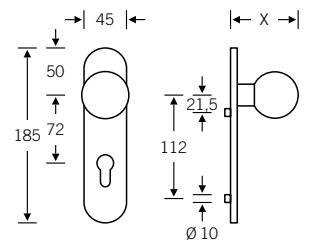
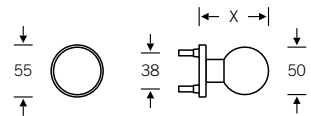
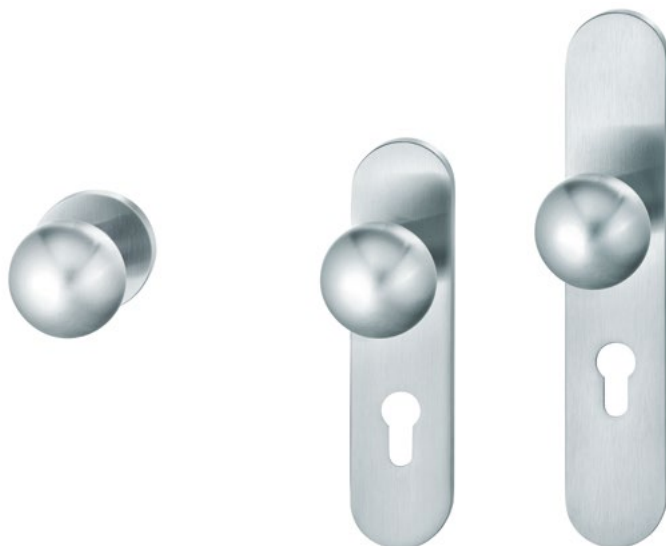

Product codes for the lever/knob sets can be found on the following pages; for individual components, see page 328 ff.

Lever/lever sets

Broad backplate sets available upon request; for flush-fitted roses, see page 536 f.

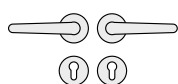

- 🔑 12 1023 013 (N)
- 🔑 72 1023 613 (R)
- 🔑 76 1023 613 (R)
- 🔑 79 1053 613 (R)

- 🔑 12 1023 047 (prv)
- 🔑 72 1023 614 (L)
- 🔑 76 1023 614 (L)
- 🔑 79 1053 614 (L)

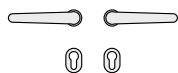

- 🔑 15 1023 013 (N)

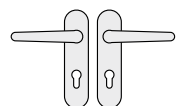

- 🔑 12 1023 007 (N)
- 🔑 72 1023 607 (R)
- 🔑 76 1023 607 (R)
- 🔑 79 1053 607 (R)

- 🔑 72 1023 608 (L)
- 🔑 76 1023 608 (L)
- 🔑 79 1053 608 (L)

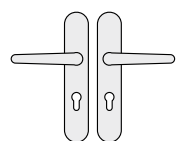

- 🔑 12 1023 027 (N)
- 🔑 72 1023 627 (R)
- 🔑 76 1023 627 (R)
- 🔑 79 1053 627 (R)

- 🔑 72 1023 628 (L)
- 🔑 76 1023 628 (L)
- 🔑 79 1053 628 (L)

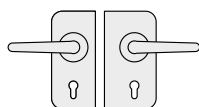

- 🔑 13 4223 041 (R) with 10 1023 00500 (N)
- 🔑 13 4223 042 (R) with 12 1023 013 (N)
- 🔑 13 4223 042 (R) with 72 1023 613 (R)

- 🔑 13 4223 051 (L) with 10 1023 00500 (N)
- 🔑 13 4223 052 (L) with 12 1023 013 (N)
- 🔑 13 4223 052 (L) with 72 1023 614 (L)

Sets for narrow-stile doors



- 🔑 09 1023 111
- 🔑 09 1023 112 (refit to ILS possible)
- 🔑 09 1053 112 (refit to ILS possible)

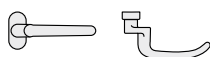

- 🔑 06 1023 011
- 🔑 06 1023 012
- 🔑 06 1053 012

- 🔑 06 1023 023 (ILS)
- 🔑 06 1053 023 (ILS)



- 07 0846 228 (fixed; aluminium, stainless steel and bronze)
- 🔑 07 0846 228 (fixed; stainless steel and bronze)
- 🔑 07 0846 428 (fixed; aluminium)



- 17 1757

Lever/knob sets

Broad backplate sets available upon request; for flush-fitted roses, see page 536 f.

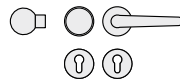

- | | |
|-----------------|-------------------|
| 12 1023 015 (N) | 72 1023 616 (L) |
| 72 1023 615 (R) | 76 1023 615 (R) |
| 76 1023 615 (R) | 79 1053 615 (R) |
| 79 1053 615 (R) | 79 1053 619 (ILS) |

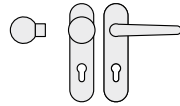

- | | |
|-----------------|-------------------|
| 12 1023 009 (N) | 72 1023 610 (L) |
| 72 1023 609 (R) | 76 1023 609 (R) |
| 76 1023 609 (R) | 79 1053 609 (R) |
| 79 1053 609 (R) | 79 1053 611 (ILS) |

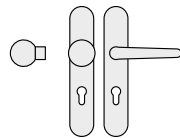

- | | |
|-----------------|-------------------|
| 12 1023 029 (N) | 72 1023 630 (L) |
| 72 1023 629 (R) | 76 1023 629 (R) |
| 76 1023 629 (R) | 79 1053 629 (R) |
| 79 1053 629 (R) | 79 1053 631 (ILS) |

WC sets

Broad backplate sets available upon request; for flush-fitted roses, see page 536 f.

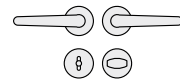

- | | |
|-----------------|-----------------|
| 12 1023 019 (N) | 72 1023 620 (L) |
| 72 1023 619 (R) | |

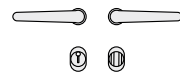

- | |
|-----------------|
| 15 1023 019 (N) |
|-----------------|

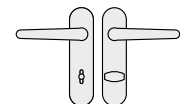

- | | |
|-----------------|-----------------|
| 12 1023 011 (N) | 72 1023 612 (L) |
| 72 1023 611 (R) | |

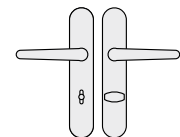

- | | |
|-----------------|-----------------|
| 12 1023 031 (N) | 72 1023 632 (L) |
| 72 1023 631 (R) | |

Window handles

Custom-coordinated lifting/sliding door handle available upon request, see page 10



- 34 1023 09030 (rose 27 × 62 × 10)
- 34 1023 09039 (rose 32.5 × 70 × 10)
- 34 1023 09034 (rose 25.5 × 60.5 flush-fitted)
- 34 1023 170 (lock adaptor RC 1–6)
- 34 1023 076 (lock adaptor with push-button RC 1–6)
- 34 1023 711 (plug-in handle for timber/metal profiles, Ø 30)
- 34 1023 751 (plug-in handle for PVC profiles, Ø 30)

N = non-handed
 prv = lever handle with privacy function
 R = DIN RH, opening inwards
 L = DIN LH, opening inwards
 ILS = inactive-leaf set

Female handles
 Plug-in handle for doors
 FSB ASL®

FSB AGL®
 FS heavy-duty fitting
 EN 179 heavy-duty fitting

For bearings, see page 52 ff.

In the autumn of 1996, Düsseldorf-based interior designer Heike Falkenberg asked FSB to recreate an old handle design for a renovation job. Using the sketch she submitted, FSB's developers milled a prototype out of the FSB 1076 handle. It was recently reinterpreted by giving it a square rose.

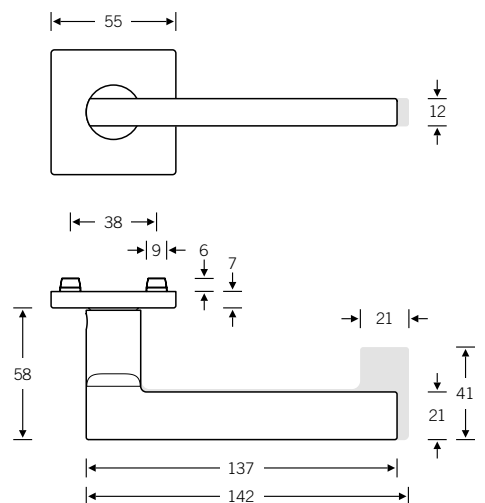
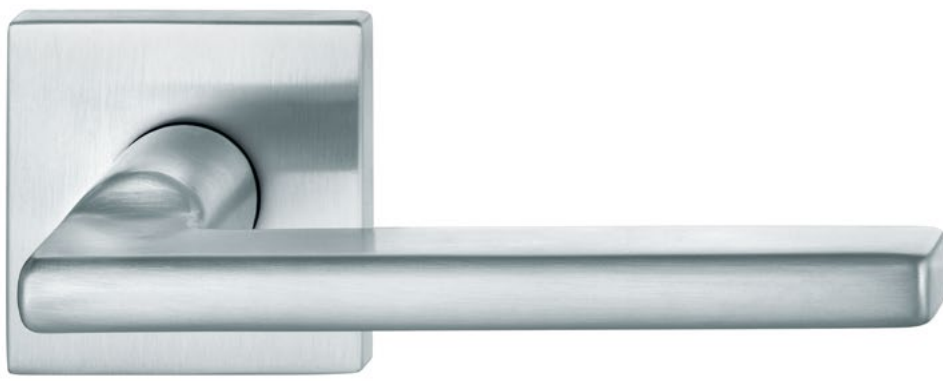

Design: Heike Falkenberg

EN 179 model: FSB 1031
Lever handle with return-to-door

Other variants:
– round roses
– oval/angular backplates

Lever handle with privacy function

12 1035

Push-button lock, see page 526 ff.

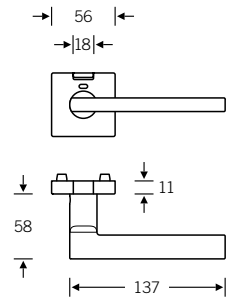

Plug-in handle for doors

15 1035

4

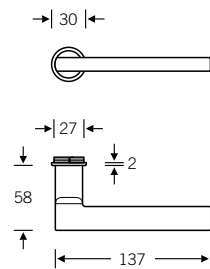

Window handle

Plug-in handle for windows

34 1035

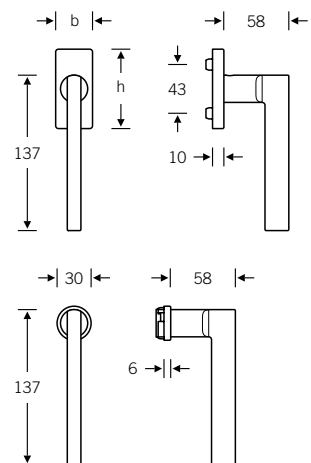

Custom-coordinated lifting/sliding door handle available upon request, see page 10

Lever handles for narrow-stile doors

09 1031 (in-line, EN 179)
06 1031 (cranked, EN 179)

Option without return-to-door:
09 1035 (in-line)
06 1035 (cranked)



Model 09 1031



Model 09 1035



Model 06 1031



Model 06 1035

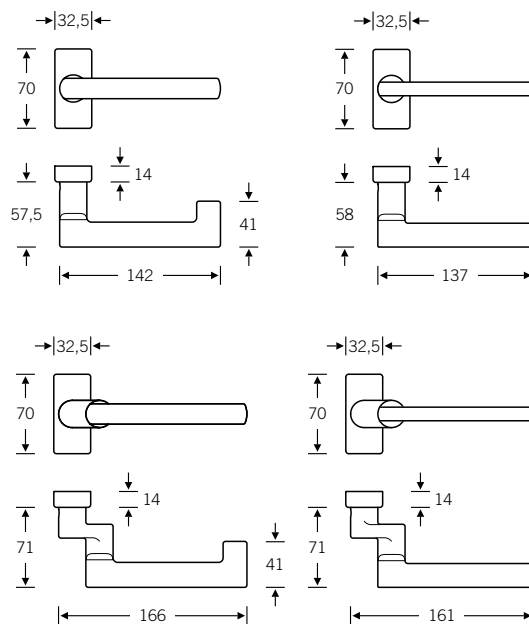

Doorknob for narrow-stile doors

07 0812 (cranked)

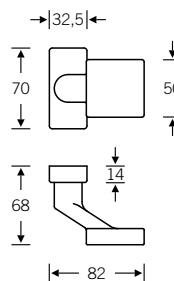

Glass door fitting

13 4220 with 10 1035

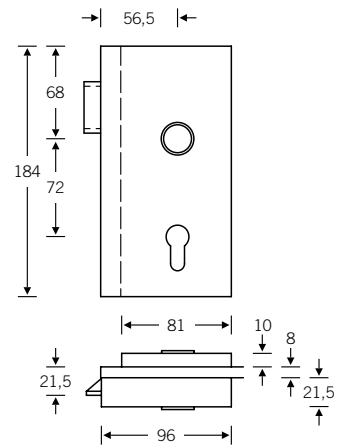

4

Lever/knob sets

Doorknob for flush doors

Knob backplates

Aluminium $\varnothing = 50$
Stainless steel $\varnothing = 55$

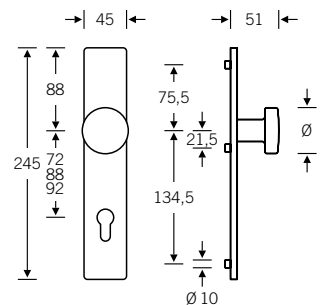
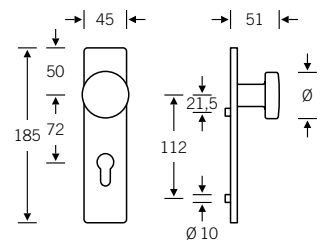
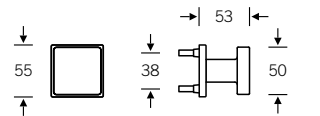

Product codes for the lever/knob sets can be found on the following pages; for individual components, see page 328 ff.

Lever/lever sets

Broad backplate sets available upon request; for flush-fitted roses, see page 536 f.

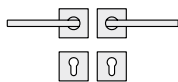

- 12 1035 041 (N)
- 72 1035 641 (R)
- 76 1035 639 (R)*
- 79 1031 639 (R)

- 12 1035 047 (prv)
- 72 1035 642 (L)
- 76 1035 640 (L)*
- 79 1031 640 (L)

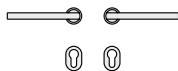

- 15 1035 013 (N)

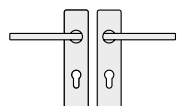

- 12 1035 001 (N)
- 72 1035 601 (R)
- 76 1035 601 (R)*
- 79 1031 601 (R)

- 72 1035 602 (L)
- 76 1035 602 (L)*
- 79 1031 602 (L)

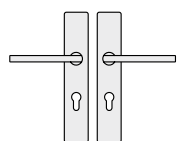

- 12 1035 021 (N)
- 72 1035 621 (R)
- 76 1035 621 (R)*
- 79 1031 621 (R)

- 72 1035 622 (L)
- 76 1035 622 (L)*
- 79 1031 622 (L)

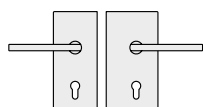

- 13 4220 041 (R) with 10 1035 00500 (N)
- 13 4220 042 (R) with 12 1035 041 (N)
- 13 4220 042 (R) with 72 1035 641 (R)
- 13 4220 090** with 76 1035 639 (R)
- 13 4220 090** with 79 1031 939 (N)

- 13 4220 051 (L) with 10 1035 00500 (N)
- 13 4220 052 (L) with 12 1035 041 (N)
- 13 4220 052 (L) with 72 1035 642 (L)
- 13 4220 090** with 76 1035 640 (L)

Sets for narrow-stile doors

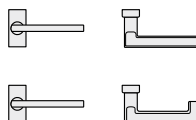

- 09 1035 171
- 09 1035 172 (refit to ILS possible)*
- 09 1031 172 (refit to ILS possible)

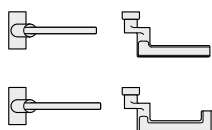

- 06 1035 071
- 06 1035 072*
- 06 1031 072
- 06 1035 073 (ILS)*
- 06 1031 073 (ILS)



- 07 0812 229 (fixed; aluminium and stainless steel)
- 07 0812 229 (fixed; stainless steel)
- 07 0812 429 (fixed; aluminium)



- 17 1778

* In stainless steel only; for ÖNORM compliance also in aluminium

** Fire safety and EN 179 variants available only in stainless steel; for variants, see page 508

Lever/knob sets

Broad backplate sets available upon request;
for flush-fitted roses, see page 536 f.



- 12 1035 043 (N)
- 72 1035 643 (R)
- 76 1035 641 (R)*
- 79 1031 641 (R)
- 79 1031 643 (ILS)
- 72 1035 644 (L)
- 76 1035 642 (L)*
- 79 1031 642 (L)

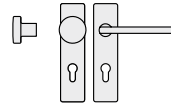

- 12 1035 003 (N)
- 72 1035 603 (R)
- 76 1035 603 (R)*
- 79 1031 603 (R)
- 79 1031 605 (ILS)
- 72 1035 604 (L)
- 76 1035 604 (L)*
- 79 1031 604 (L)

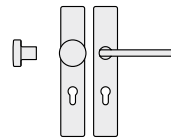

- 12 1035 023 (N)
- 72 1035 623 (R)
- 76 1035 623 (R)*
- 79 1031 623 (R)
- 79 1031 625 (ILS)
- 72 1035 624 (L)
- 76 1035 624 (L)*
- 79 1031 624 (L)

WC sets

Broad backplate sets available upon request;
for flush-fitted roses, see page 536 f.

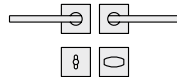

- 12 1035 045 (N)
- 72 1035 645 (R)
- 72 1035 646 (L)

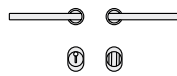

- 15 1035 019 (N)

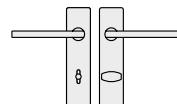

- 12 1035 005 (N)
- 72 1035 605 (R)
- 72 1035 606 (L)

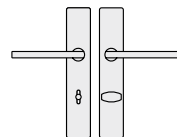

- 12 1035 025 (N)
- 72 1035 625 (R)
- 72 1035 626 (L)

Window handles

Custom-coordinated lifting/sliding door
handle available upon request, see page 10

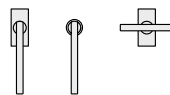

- 34 1035 09032 (rose 27 × 62 × 10)
- 34 1035 09040 (rose 32.5 × 70 × 10)
- 34 1035 09036 (rose 25.5 × 60.5 flush-fitted)
- 34 1035 180 (lock adaptor RC 1–6)
- 34 1035 086 (lock adaptor with push-button RC 1–6)
- 34 1035 711 (plug-in handle for timber/metal profiles, Ø 30)
- 34 1035 751 (plug-in handle for PVC profiles, Ø 30)
- 34 3784 (tee handle for window)

N = non-handed
prv = lever handle with privacy function
R = DIN RH, opening inwards
L = DIN LH, opening inwards
ILS = inactive-leaf set

Female handles
Plug-in handle for doors
FSB ASL®

FSB AGL®
FS heavy-duty fitting
EN 179 heavy-duty fitting

For bearings, see page 52 ff.

The FSB 1045 is based on the FSB 1015 model, which was conceived in the 1930s by a company called Wehag. Given the unceasing use of the FSB 1015 model in commercial buildings, we have supplemented it with a variant featuring a return-to-door that conforms to EN 179.

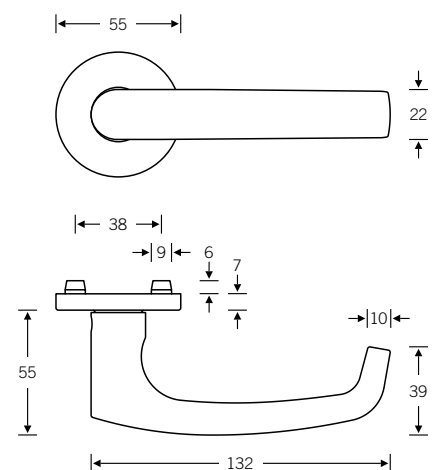

 EN 179 model:
Lever handle with return-to-door

Other variants:
 – square roses
 – oval/angular backplates

Lever handle with privacy function

12 1045

Push-button lock, see page 526 ff.

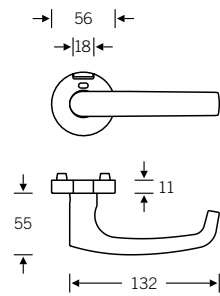

Plug-in handle for doors

15 1045

4

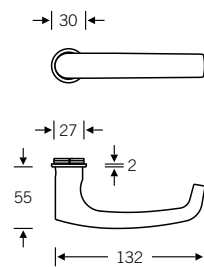

Window handle

Plug-in handle for windows

34 1015

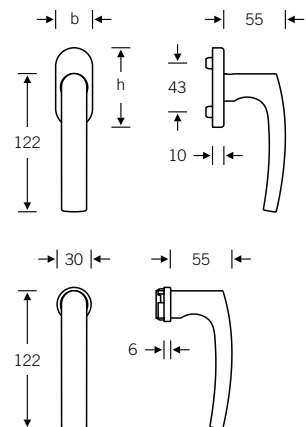

Lever handles for narrow-stile doors

09 1045 (in-line, EN 179)
06 1045 (cranked, EN 179)

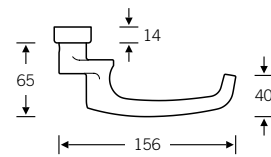
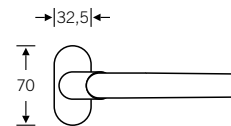
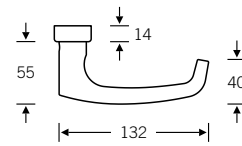
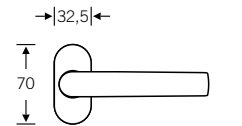

Doorknob for narrow-stile doors

07 0809 (cranked)

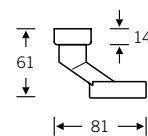
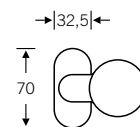

Glass door fitting

13 4223 with 72 1045

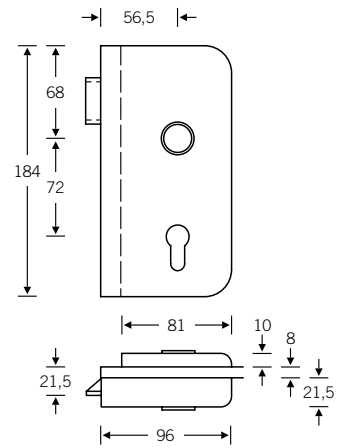

4

Lever/knob sets

Doorknob for flush doors

Knob backplates

- Aluminium $\varnothing = 50$
- Stainless steel $\varnothing = 55$
- Bronze $\varnothing = 50$

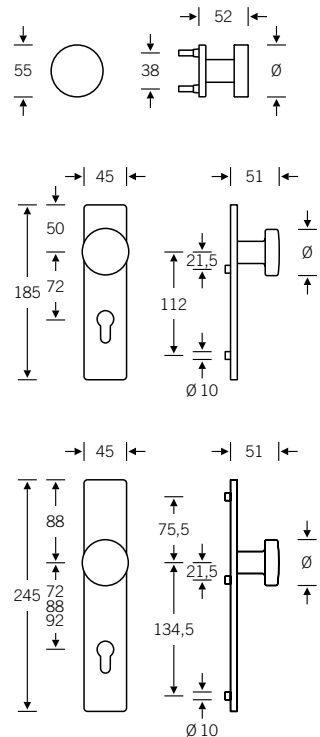

Product codes for the lever/knob sets can be found on the following pages; for individual components, see page 328 ff.

FSB 1045

Lever/lever sets

Broad backplate sets available upon request; for flush-fitted roses, see page 536 f.

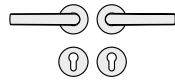

- 🔑 12 1045 013 (N)
- 🔑 72 1045 613 (R)
- 🔑 79 1045 613 (R)

- 🔑 12 1045 047 (prv)
- 🔑 72 1045 614 (L)
- 🔑 79 1045 614 (L)

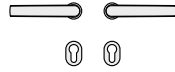

- 🔑 15 1045 013 (N)

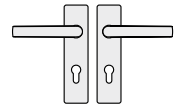

- 🔑 12 1045 001 (N)
- 🔑 72 1045 601 (R)
- 🔑 79 1045 601 (R)

- 🔑 72 1045 602 (L)
- 🔑 79 1045 602 (L)

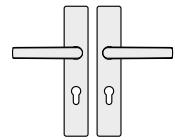

- 🔑 12 1045 021 (N)
- 🔑 72 1045 621 (R)
- 🔑 79 1045 621 (R)

- 🔑 72 1045 622 (L)
- 🔑 79 1045 622 (L)

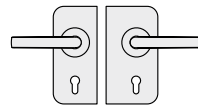

- 🔑 13 4223 041 (R) with 10 1045 00500 (N)
- 🔑 13 4223 042 (R) with 12 1045 013 (N)
- 🔑 13 4223 042 (R) with 72 1045 613 (R)

- 🔑 13 4223 051 (L) with 10 1045 00500 (N)
- 🔑 13 4223 052 (L) with 12 1045 013 (N)
- 🔑 13 4223 052 (L) with 12 1045 614 (L)

Sets for narrow-stile doors



- 🔑 09 1045 111
- 🔑 09 1045 112 (refit to ILS possible)

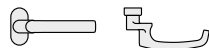

- 🔑 06 1045 011
- 🔑 06 1045 012

- 🔑 06 1045 023 (ILS)



- 07 0809 228 (fixed; aluminium and stainless steel)
- 🔑 07 0809 228 (fixed; stainless steel)
- 🔑 07 0809 428 (fixed; aluminium)

For set in bronze with knob 07 0846, see page 481



- 17 1757

Lever/knob sets

Broad backplate sets available upon request;
for flush-fitted roses, see page 536 f.

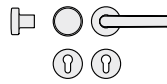

- 12 1045 017 (N)
- 72 1045 617 (R)
- 79 1045 617 (R)
- 79 1045 619 (ILS)
- 72 1045 618 (L)
- 79 1045 618 (L)

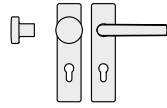

- 12 1045 003 (N)
- 72 1045 603 (R)
- 79 1045 603 (R)
- 79 1045 605 (ILS)
- 72 1045 604 (L)
- 79 1045 604 (L)

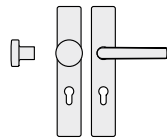

- 12 1045 023 (N)
- 72 1045 623 (R)
- 79 1045 623 (R)
- 79 1045 625 (ILS)
- 72 1045 624 (L)
- 79 1045 624 (L)

WC sets

Broad backplate sets available upon request;
for flush-fitted roses, see page 536 f.

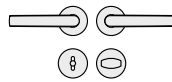

- 12 1045 019 (N)
- 72 1045 619 (R)
- 72 1045 620 (L)

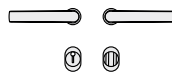

- 15 1045 019 (N)

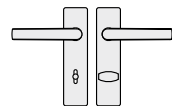

- 12 1045 005 (N)
- 72 1045 605 (R)
- 72 1045 606 (L)

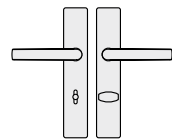

- 12 1045 025 (N)
- 72 1045 625 (R)
- 72 1045 626 (L)

Window handles



- 34 1015 09030 (rose 27 × 62 × 10)
- 34 1015 09039 (rose 32.5 × 70 × 10)
- 34 1015 09034 (rose 25.5 × 60.5 flush-fitted)
- 34 1015 170 (lock adaptor RC 1–6)
- 34 1015 076 (lock adaptor with push-button RC 1–6)
- 34 1015 711 (plug-in handle for timber/metal profiles, Ø 30)
- 34 1015 751 (plug-in handle for PVC profiles, Ø 30)

N = non-handed
prv = lever handle with privacy function
R = DIN RH, opening inwards
L = DIN LH, opening inwards
ILS = inactive-leaf set

Female handles
 Plug-in handle for doors
 FSB ASL®

FSB AGL®
 FS heavy-duty fitting
 EN 179 heavy-duty fitting

For bearings, see page 52 ff.

The FSB 1051 lever handle model has come to epitomise FSB. The 'Schneider Handle' was one of Johannes Potente's supreme creation and a market leader in the 1960s. It exudes great harmony with its moulded-to-the-hand styling. The FSB 1051 is one of four models designed by Johannes Potente now on permanent display at the MoMA in New York.

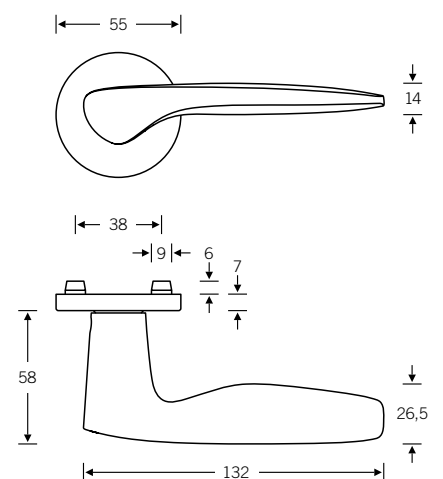

Design: Johannes Potente
 Pictured: right-hand model

Other variants:
 – square roses
 – oval/angular backplates

Lever handle with privacy function

12 1051

Push-button lock, see page 526 ff.

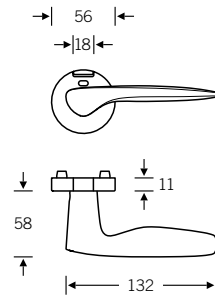

Plug-in handle for doors

15 1051

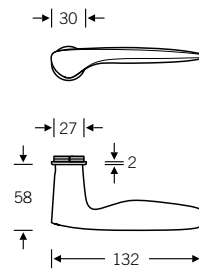

Window handle

Plug-in handle for windows

34 1058

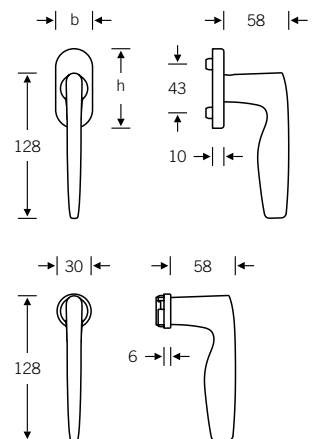

Lever/lever sets

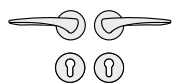

➤ 12 1051 013 (N)

➤ 12 1051 047 (prv)

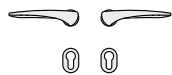

➤ 15 1051 013 (N)

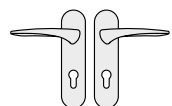

➤ 12 1051 007 (N)

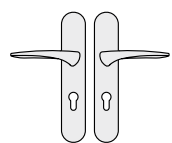

➤ 12 1051 027 (N)

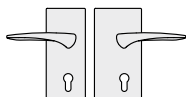

➤ 13 4224 042 (R) with
10 1051 00500 (N)

➤ 13 4224 052 (L) with
10 1051 00500 (N)

Lever/knob sets

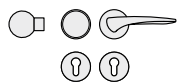

➤ 12 1051 015 (R)

➤ 12 1051 016 (L)

For associated knobs, see page 328 f.

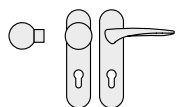

➤ 12 1051 009 (R)

➤ 12 1051 010 (L)

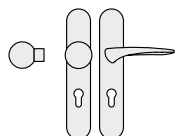

➤ 12 1051 029 (R)

➤ 12 1051 030 (L)

WC sets

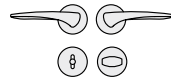

 12 1051 019 (N)

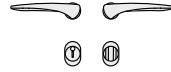

 15 1051 019 (N)

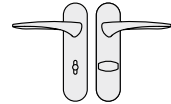

 12 1051 011 (N)

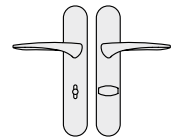



 12 1051 031 (N)



Window handles



- 34 1058 09030 (rose 27 × 62 × 10)
- 34 1058 09039 (rose 32.5 × 70 × 10)
- 34 1058 170 (lock adaptor RC 1–6)
- 34 1058 076 (lock adaptor with push-button RC 1–6)
- 34 1058 711 (plug-in handle for timber/metal profiles, Ø 30)
- 34 1058 751 (plug-in handle for PVC profiles, Ø 30)

N = non-handed
 prv = lever handle with privacy function
 R = DIN RH, opening inwards
 L = DIN LH, opening inwards
 ILS = inactive-leaf set

 Female handles
 Plug-in handle for doors
 FSB ASL®

 FSB AGL®
 FS heavy-duty fitting
 EN 179 heavy-duty fitting

For bearings, see page 52 ff.

The FSB 1058 was Johannes Potente's own personal favourite. It is not known why, only two years after designing his superlative FSB 1051, he followed it up with this redesign. The FSB 1058 is one of four models designed by Johannes Potente now on permanent display at the MoMA in New York.

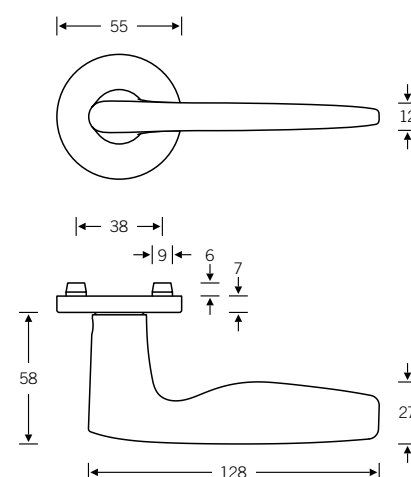

Design: Johannes Potente

Other variants:
– square roses
– oval/angular backplates

Lever handle with privacy function

12 1058

Push-button lock, see page 526 ff.

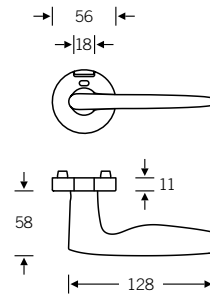

Plug-in handle for doors

15 1058

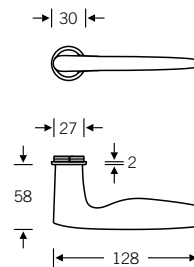

Window handle

Plug-in handle for windows

34 1058

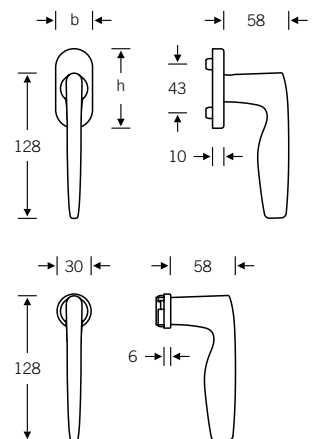

Lever/lever sets

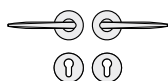

➤ 12 1058 013 (N)

➤ 12 1058 047 (prv)

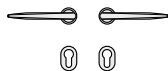

➤ 15 1058 013 (N)

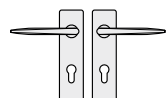

➤ 12 1058 001 (N)

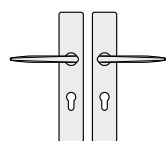

➤ 12 1058 021 (N)

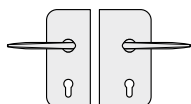

➤ 13 4223 041 (R) with
10 1058 00500 (N)

➤ 13 4223 042 (R) with
12 1058 013 (N)

➤ 13 4223 051 (L) with
10 1058 00500 (N)

➤ 13 4223 052 (L) with
12 1058 013 (N)

Lever/knob sets

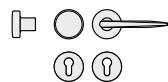

➤ 12 1058 017 (N)

For associated knobs, see page 328 f.

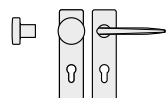

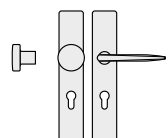

➤ 12 1058 003 (N)



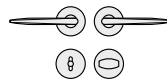

➤ 12 1058 023 (N)

WC sets

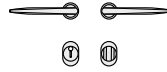

 12 1058 019 (N)



 15 1058 019 (N)

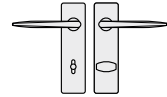

 12 1058 005 (N)

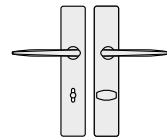



 12 1058 025 (N)



Window handles



- 34 1058 09030 (rose 27 × 62 × 10)
- 34 1058 09039 (rose 32.5 × 70 × 10)
- 34 1058 170 (lock adaptor RC 1–6)
- 34 1058 076 (lock adaptor, with push-button RC 1–6)
- 34 1058 711 (plug-in handle for timber/metal profiles, Ø 30)
- 34 1058 751 (plug-in handle for PVC profiles, Ø 30)

N = non-handed
 prv = lever handle with privacy function
 R = DIN RH, opening inwards
 L = DIN LH, opening inwards
 ILS = inactive-leaf set

 Female handles
 Plug-in handle for doors
 FSB ASL®

 FSB AGL®
 FS heavy-duty fitting
 EN 179 heavy-duty fitting

For bearings, see page 52 ff.

This is a lever handle design that became 'really famous' during the heyday of colour in the 1970s. For many architects who were schoolchildren at the time, this handle epitomises the architecture of the age.

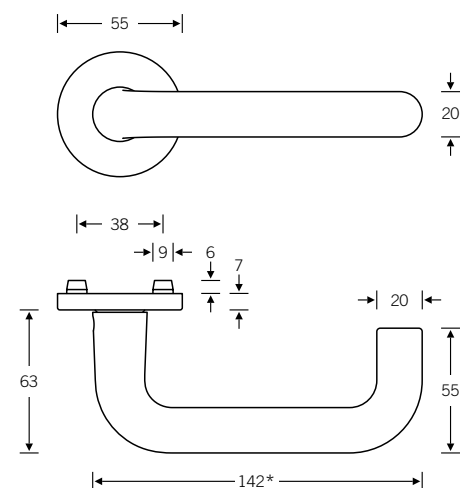

* Aluminium: 145 mm

 EN 179 model:
Lever handle with return-to-door

Other variants:
– square roses
– oval/angular backplates

Lever handle with privacy function

12 1070

Push-button lock, see page 526 ff.

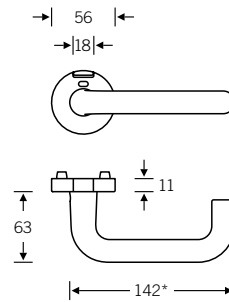

* Aluminium: 145 mm

Plug-in handle for doors

15 1070

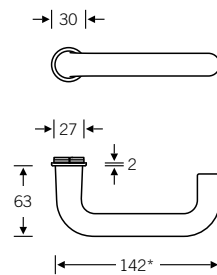

* Aluminium: 145 mm

Window handle

Plug-in handle for windows

34 1070

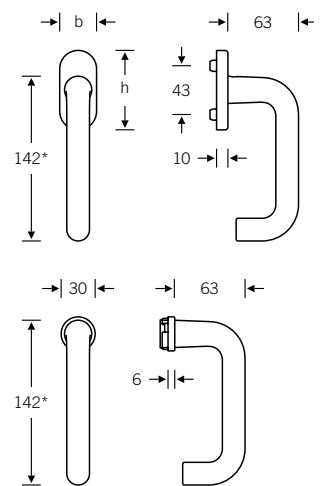

* Aluminium: 145 mm



Lever handles for narrow-stile doors

09 1070 (in-line, EN 179)
06 1070 (cranked, EN 179)

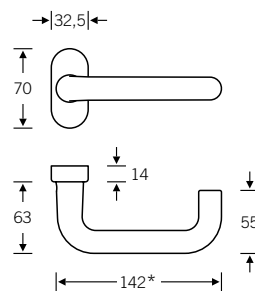

* Aluminium: 145 mm

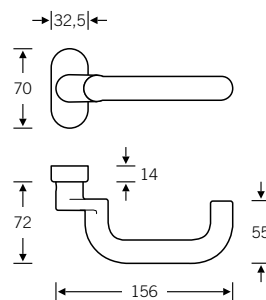

Doorknob for narrow-stile doors

07 0846 (cranked)

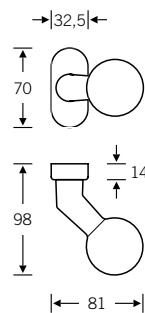

Glass door fitting

13 4223 with 72 1070

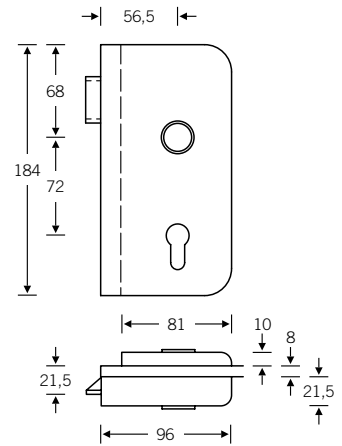

4

Lever/knob sets

Doorknob for flush doors

Knob backplates

Aluminium X = 77 mm
Stainless steel X = 73 mm

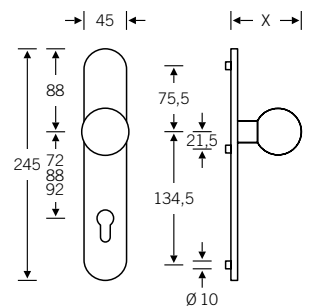
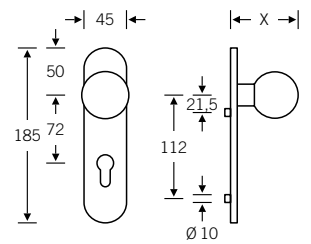
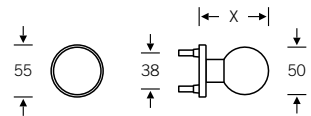
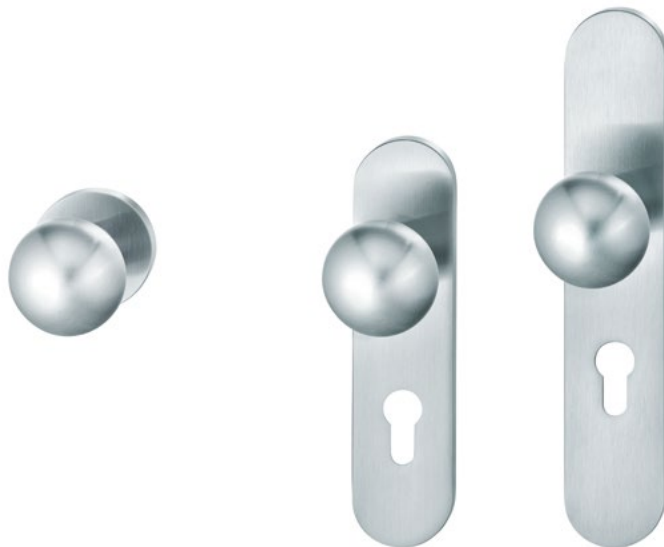

Product codes for the lever/knob sets can be found on the following pages; for individual components, see page 328 ff.

Lever/lever sets

Broad backplate sets available upon request; for flush-fitted roses, see page 386 f.

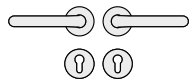

12 1070 013 (N)
 72 1070 613 (R)
 79 1070 613 (R)

12 1070 047 (prv)
 72 1070 614 (L)
 79 1070 614 (L)

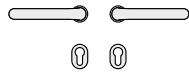

15 1070 013 (N)

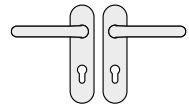

12 1070 007 (N)
 72 1070 607 (R)
 79 1070 607 (R)

72 1070 608 (L)
 79 1070 608 (L)

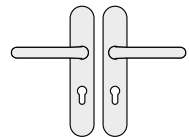

12 1070 027 (N)
 72 1070 627 (R)
 79 1070 627 (R)

72 1070 628 (L)
 79 1070 628 (L)

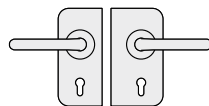

13 4223 041 (R) with
 10 1070 00500 (N)
 13 4223 042 (R) with
 12 1070 013 (N)
 13 4223 042 (R) with
 72 1070 613 (R)

13 4223 051 (L) with
 10 1070 00500 (N)
 13 4223 052 (L) with
 12 1070 013 (N)
 13 4223 052 (L) with
 72 1070 614 (L)

Sets for narrow-stile doors

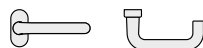

09 1070 111
 09 1070 112 (refit to ILS possible)

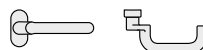

06 1070 011
 06 1070 012

06 1070 023 (ILS)



07 0846 228 (fixed; aluminium and stainless steel)
 07 0846 228 (fixed; stainless steel)
 07 0846 428 (fixed; aluminium)



17 1757

Lever/knob sets

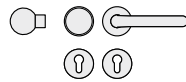

- 12 1070 015 (N)
- 72 1070 615 (R)
- 79 1070 615 (R)
- 79 1070 619 (ILS)
- 72 1070 616 (L)
- 79 1070 616 (L)

Broad backplate sets available upon request

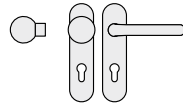

- 12 1070 009 (N)
- 72 1070 609 (R)
- 79 1070 609 (R)
- 79 1070 611 (ILS)
- 72 1070 610 (L)
- 79 1070 610 (L)

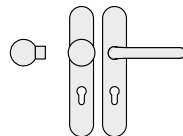

- 12 1070 029 (N)
- 72 1070 629 (R)
- 79 1070 629 (R)
- 79 1070 631 (ILS)
- 72 1070 630 (L)
- 79 1070 630 (L)

WC sets

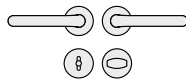

- 12 1070 019 (N)
- 72 1070 619 (R)
- 72 1070 620 (L)

Broad backplate sets available upon request;
for flush-fitted roses, see page 386 f.

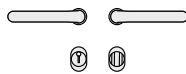

- 15 1070 019 (N)

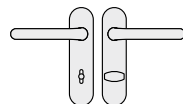

- 12 1070 011 (N)
- 72 1070 611 (R)
- 72 1070 612 (L)

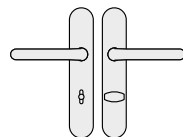

- 12 1070 031 (N)
- 72 1070 631 (R)
- 72 1070 632 (L)

Window handles



- 34 1070 09030 (rose 27 × 62 × 10)
- 34 1070 09039 (rose 32.5 × 70 × 10)
- 34 1070 09034 (rose 25.5 × 60.5 flush-fitted)
- 34 1070 170 (lock adaptor RC 1–6)
- 34 1070 076 (lock adaptor with push-button RC 1–6)
- 34 1070 711 (plug-in handle for timber/metal profiles, Ø 30)
- 34 1070 751 (plug-in handle for PVC profiles, Ø 30)

N = non-handed
 prv = lever handle with privacy function
 R = DIN RH, opening inwards
 L = DIN LH, opening inwards
 ILS = inactive-leaf set

Female handles
 Plug-in handle for doors
 FSB ASL®

FSB AGL®
 FS heavy-duty fitting
 EN 179 heavy-duty fitting

For bearings, see page 52 ff.

In the 1920s, Robert Mallet-Stevens mitred two sections of tubing together to create the FSB 1076. Ludwig Wittgenstein bent brass tubing for the FSB 1147. And Walter Gropius and Adolf Meyer married an angled spindle to a handle bushing to produce the FSB 1102. But to this day we still don't know who it was that picked up a saw and 'liberated' the FSB 1147 from its hemispherical tip.

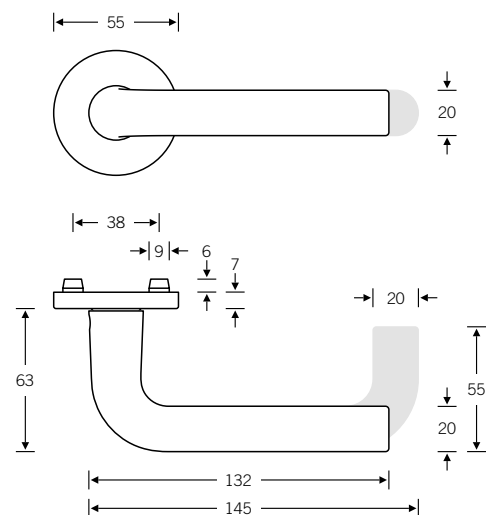

EN 179 model: FSB 1070
Lever handle with return-to-door

Other variants:
– square roses
– oval/angular backplates

Lever handle with privacy function

12 1075

Push-button lock, see page 526 ff.

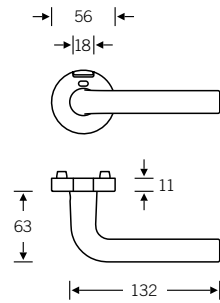

Plug-in handle for doors

15 1075

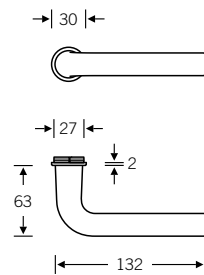

Window handle

Plug-in handle for windows

34 1075

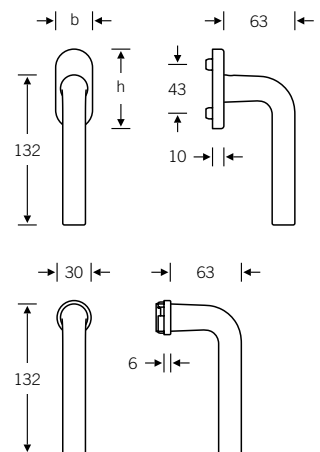

Custom-coordinated lifting/sliding door handle available upon request, see page 10

Lever/lever sets

Broad backplate sets available upon request; for flush-fitted roses, see page 386 f.

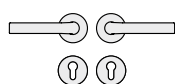

➤ 12 1075 013 (N)

➤ 12 1075 047 (prv)

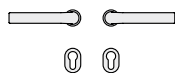

➤ 15 1075 013 (N)

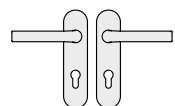

➤ 12 1075 007 (N)

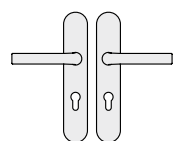

➤ 12 1075 027 (N)

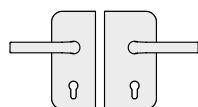

➤ 13 4223 041 (R) with
10 1075 00500 (N)

➤ 13 4223 042 (R) with
12 1075 013 (N)

➤ 13 4223 051 (L) with
10 1075 00500 (N)

➤ 13 4223 052 (L) with
12 1075 013 (N)

Lever/knob sets

Broad backplate sets available upon request; for associated knobs, see page 328 f.



➤ 12 1075 015 (N)

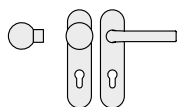

➤ 12 1075 009 (N)

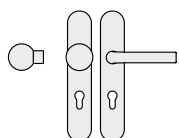

➤ 12 1075 029 (N)

WC sets

Broad backplate sets available upon request;
for flush-fitted roses, see page 386 f.

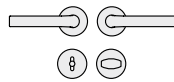

 12 1075 019 (N)

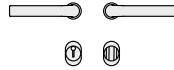

 15 1075 019 (N)

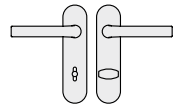

 12 1075 011 (N)

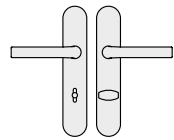

 12 1075 031 (N)



Window handles



Custom-coordinated lifting/sliding door
handle available upon request, see page 10



- 34 1075 09030 (rose 27 × 62 × 10)
- 34 1075 09039 (rose 32.5 × 70 × 10)
- 34 1075 09034 (rose 25.5 × 60.5 flush-fitted)
- 34 1075 170 (lock adaptor RC 1–6)
- 34 1075 076 (lock adaptor with push-button RC1–6)
- 34 1075 711 (plug-in handle for timber/metal profiles, Ø 30)
- 34 1075 751 (plug-in handle for PVC profiles, Ø 30)

N = non-handed
prv = lever handle with privacy function
R = DIN RH, opening inwards
L = DIN LH, opening inwards
ILS = inactive-leaf set

 Female handles
 Plug-in handle for doors
 FSB ASL®

 FSB AGL®
 FS heavy-duty fitting
 EN 179 heavy-duty fitting

For bearings, see page 52 ff.

It was the architect Robert Mallet-Stevens (1886–1945) who hit upon the idea of splitting a round tube in two and mitring the ends back together again at right angles. His creation is now known as the ‘Frankfurt model’. Rediscovered in Frankfurt when the architecture museum there was rebuilt, the handle proceeded to take the market by storm.

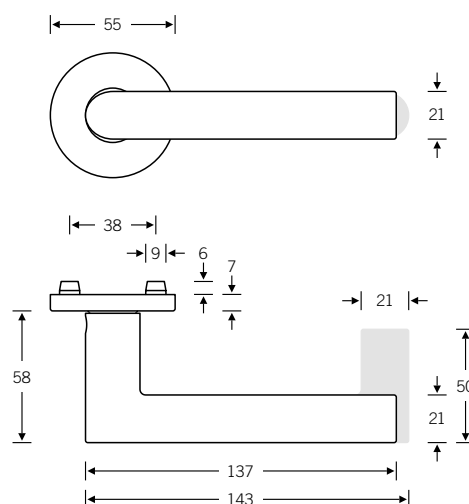

 EN 179 model: FSB 1016
 Lever handle with return-to-door

Other variants:
 – square roses
 – oval/angular backplates

Lever handle with privacy function

12 1076

Push-button lock, see page 526 ff.

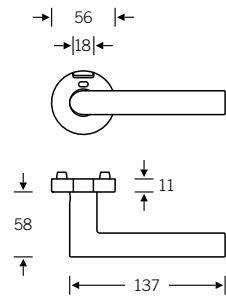

Plug-in handle for doors

15 1076

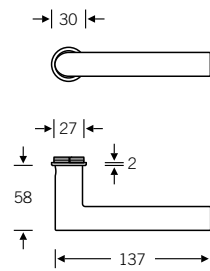

Window handle

Plug-in handle for windows

34 1076

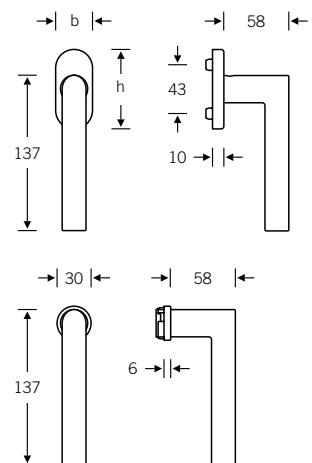

Lifting/sliding door handle

34 1076 011

For more variants, see page 444
For parallel slide/tilt fitting, see page 439

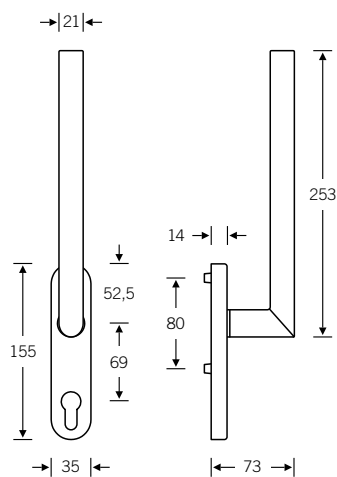

Lever handles
for narrow-stile doors



09 1076 (in-line)
06 1076 (cranked)

Option with return-to-door:
09 1016 (in-line, EN 179)
06 1016 (cranked, EN 179)
See page 110

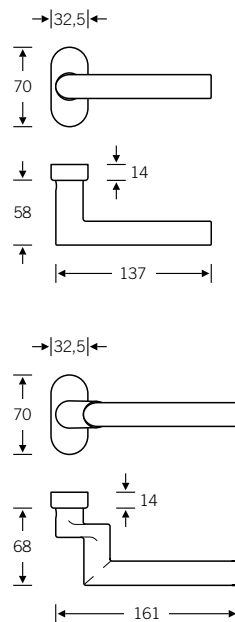

Doorknob
for narrow-stile doors

07 0809 (cranked)

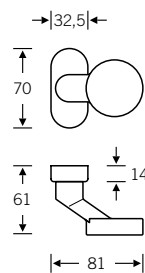

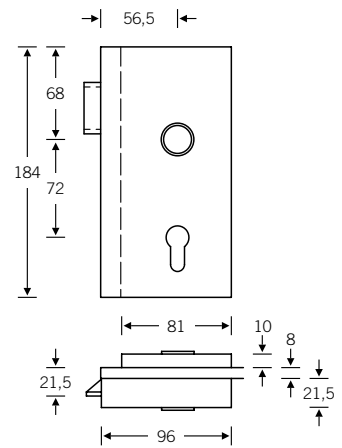

Lever/knob sets

Doorknob for flush doors

Knob backplates

- Aluminium $\varnothing = 50$
- Stainless steel $\varnothing = 55$
- Bronze $\varnothing = 50$

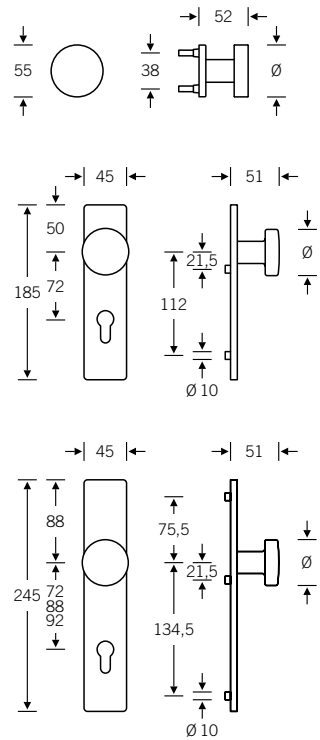

Product codes for the lever/knob sets can be found on the following pages; for individual components, see page 328 ff.

Lever/lever sets

Broad backplate sets available upon request; for flush-fitted roses, see page 536 f.

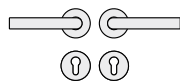

- 12 1076 013 (N)
- 72 1076 613 (R)
- 76 1076 613 (R)
- 79 1016 613 (R)

- 12 1076 047 (prv)
- 72 1076 614 (L)
- 76 1076 614 (L)
- 79 1016 614 (L)

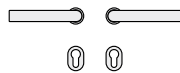

- 15 1076 013 (N)

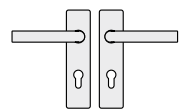

- 12 1076 001 (N)
- 72 1076 601 (R)
- 76 1076 601 (R)
- 79 1016 601 (R)

- 72 1076 602 (L)
- 76 1076 602 (L)
- 79 1016 602 (L)

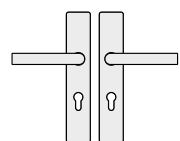

- 12 1076 021 (N)
- 72 1076 621 (R)
- 76 1076 621 (R)
- 79 1016 621 (R)

- 72 1076 622 (L)
- 76 1076 622 (L)
- 79 1016 622 (L)

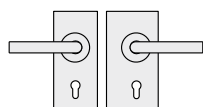

- 13 4220 041 (R) with 10 1076 00500 (N)
- 13 4220 042 (R) with 12 1076 013 (N)
- 13 4220 042 (R) with 72 1076 613 (R)
- 13 4220 090* with 76 1076 613 (R)
- 13 4220 090* with 79 1016 913 (N)

- 13 4220 051 (L) with 10 1076 00500 (N)
- 13 4220 052 (L) with 12 1076 013 (N)
- 13 4220 052 (L) with 72 1076 614 (L)
- 13 4220 090* with 76 1076 614 (L)

Sets for narrow-stile doors

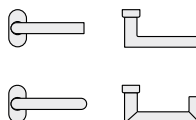

- 09 1076 111
- 09 1076 112 (refit to ILS possible)
- 09 1016 111
- 09 1016 112 (refit to ILS possible)

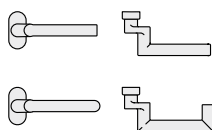

- 06 1076 011
- 06 1076 012
- 06 1016 011
- 06 1016 012
- 06 1076 023 (ILS)
- 06 1016 023 (ILS)



- 07 0809 228 (fixed; aluminium and stainless steel)
- 07 0809 228 (fixed; stainless steel)
- 07 0809 428 (fixed; aluminium)

For set in bronze with knob 07 0846, see page 481



- 17 1757

* Fire safety and EN 179 variants available only in stainless steel; for variants, see page 62

Lever/knob sets

Broad backplate sets available upon request;
for flush-fitted roses, see page 536 f.

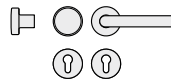

- | | |
|-------------------|-----------------|
| 12 1076 017 (N) | 72 1076 618 (L) |
| 72 1076 617 (R) | 76 1076 618 (L) |
| 76 1076 617 (R) | 79 1016 618 (L) |
| 79 1016 617 (R) | |
| 79 1016 619 (ILS) | |

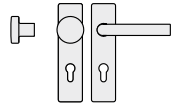

- | | |
|-------------------|-----------------|
| 12 1076 003 (N) | 72 1076 604 (L) |
| 72 1076 603 (R) | 76 1076 604 (L) |
| 76 1076 603 (R) | 79 1016 604 (L) |
| 79 1016 603 (R) | |
| 79 1016 605 (ILS) | |

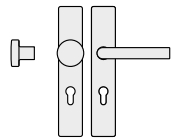

- | | |
|-------------------|-----------------|
| 12 1076 023 (N) | 72 1076 624 (L) |
| 72 1076 623 (R) | 76 1076 624 (L) |
| 76 1076 623 (R) | 79 1016 624 (L) |
| 79 1016 623 (R) | |
| 79 1016 625 (ILS) | |

WC sets

Broad backplate sets available upon request;
for flush-fitted roses, see page 536 f.

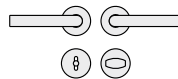

- | | |
|-----------------|-----------------|
| 12 1076 019 (N) | 72 1076 620 (L) |
| 72 1076 619 (R) | |

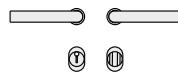

- | |
|-----------------|
| 15 1076 019 (N) |
|-----------------|

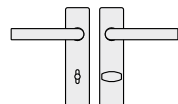

- | | |
|-----------------|-----------------|
| 12 1076 005 (N) | 72 1076 606 (L) |
| 72 1076 605 (R) | |

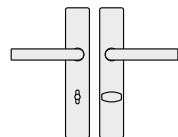

- | | |
|-----------------|-----------------|
| 12 1076 025 (N) | 72 1076 626 (L) |
| 72 1076 625 (R) | |

Window handles

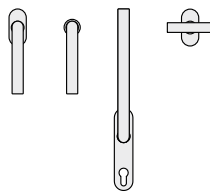

- 34 1076 09030 (rose 27 × 62 × 10)
- 34 1076 09039 (rose 32.5 × 70 × 10)
- 34 1076 09034 (rose 25.5 × 60.5 flush-fitted)
- 34 1076 170 (lock adaptor RC 1–6)
- 34 1076 076 (lock adaptor with push-button RC 1–6)
- 34 1076 711 (plug-in handle, timber/metal profiles, Ø 30)
- 34 1076 751 (plug-in handle for PVC profiles, Ø 30)
- 34 1076 714 (plug-in handle, lock adaptor RC 1–6)
- 34 1076 717 (plug-in handle with push-button RC 1–6)
- 34 3403 (tee handle for window)
- 34 1076 011 (lifting/sliding door handle)

N = non-handed
 prv = lever handle with privacy function
 R = DIN RH, opening inwards
 L = DIN LH, opening inwards
 ILS = inactive-leaf set

Female handles
 Plug-in handle for doors
 FSB ASL®

FSB AGL®
 FS heavy-duty fitting
 EN 179 heavy-duty fitting

For bearings, see page 52 ff.

Christoph Ingenhoven was inspired by the quintessential classic, the FSB 1076, which he reinterpreted both in the mitring and the grip section. What's so especially pleasing about this FSB 1078 model is the formal transition from a round neck to a grip section that is flat at the top and bottom. The companion variant with a return-to-door supplements the open model with a closed design conforming to EN 179.

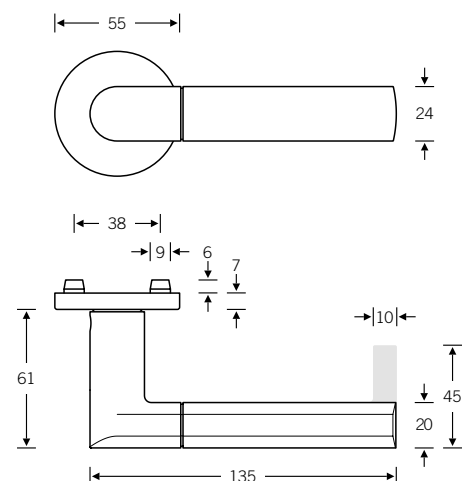

Design: Christoph Ingenhoven

 EN 179 model: FSB 1088
 Lever handle with return-to-door

Other variants:
 – square roses
 – oval/angular backplates

Lever handle with privacy function

12 1078

Push-button lock, see page 526 ff.

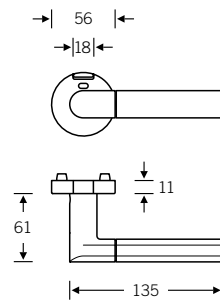

Plug-in handle for doors

15 1078

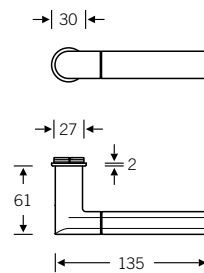

Window handle

Plug-in handle for windows

34 1078

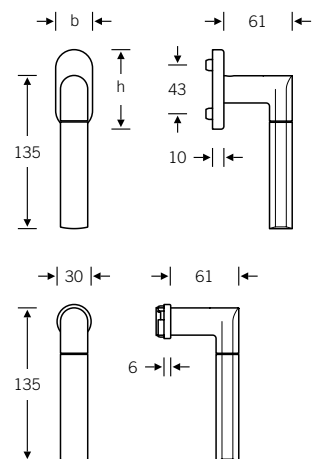

Lever handles for narrow-stile doors

09 1088 (in-line, EN 179)
06 1088 (cranked, EN 179)

Option without return-to-door:
09 1078 (in-line)
06 1078 (cranked)

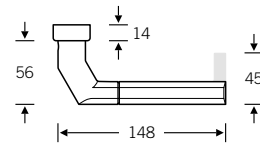
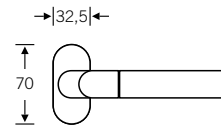
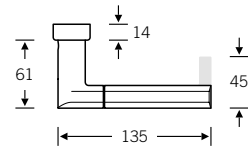
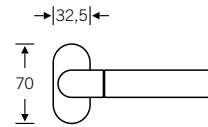

Doorknob for narrow-stile doors

07 0809 (cranked)

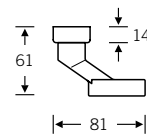
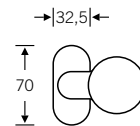

Glass door fitting

13 4220 with 10 1078

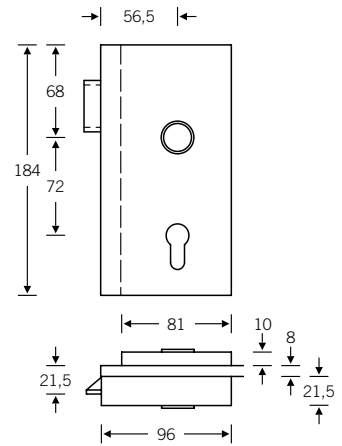

4

Lever/knob sets

Doorknob for flush doors

Knob backplates

Aluminium $\varnothing = 50$
Stainless steel $\varnothing = 55$

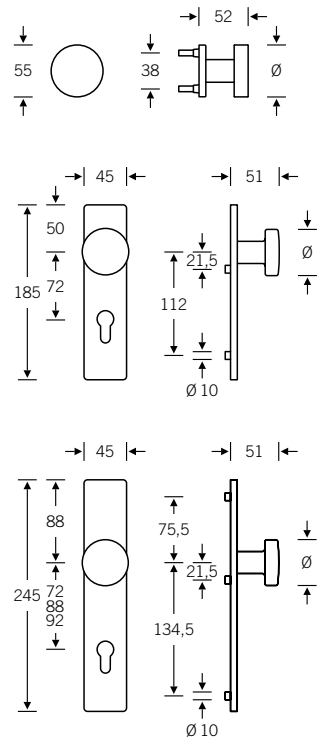

Product codes for the lever/knob sets can be found on the following pages; for individual components, see page 328 ff.

Lever/lever sets

Broad backplate sets available upon request; for flush-fitted roses, see page 536 f.

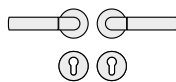

- 🔑 12 1078 013 (N)
- 🔑 72 1078 613 (R)
- 🔑 76 1078 613 (R)
- 🔑 79 1088 613 (R)

- 🔑 12 1078 047 (prv)
- 🔑 72 1078 614 (L)
- 🔑 76 1078 614 (L)
- 🔑 79 1088 614 (L)

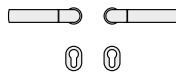

- 🔑 15 1078 013 (N)

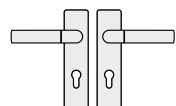

- 🔑 12 1078 001 (N)
- 🔑 72 1078 601 (R)
- 🔑 76 1078 601 (R)
- 🔑 79 1088 601 (R)

- 🔑 72 1078 602 (L)
- 🔑 76 1078 602 (L)
- 🔑 79 1088 602 (L)

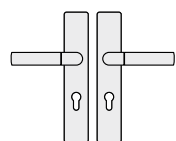

- 🔑 12 1078 021 (N)
- 🔑 72 1078 621 (R)
- 🔑 76 1078 621 (R)
- 🔑 79 1088 621 (R)

- 🔑 72 1078 622 (L)
- 🔑 76 1078 622 (L)
- 🔑 79 1088 622 (L)

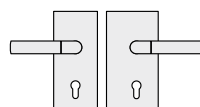

- 🔑 13 4220 041 (R) with 10 1078 00500 (N)
- 🔑 13 4220 042 (R) with 12 1078 013 (N)
- 🔑 13 4220 042 (R) with 72 1078 613 (R)
- 🔑 13 4220 090* with 76 1078 613 (R)
- 🔑 13 4220 090* with 79 1088 913 (N)

- 🔑 13 4220 051 (L) with 10 1078 00500 (N)
- 🔑 13 4220 052 (L) with 12 1078 013 (N)
- 🔑 13 4220 052 (L) with 72 1078 614 (L)
- 🔑 13 4220 090* with 76 1078 614 (L)

Sets for narrow-stile doors

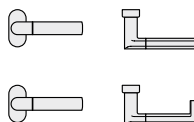

- 🔑 09 1078 111
- 🔑 09 1078 112 (refit to ILS possible)
- 🔑 09 1088 112 (refit to ILS possible)

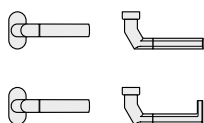

- 🔑 06 1078 011
- 🔑 06 1078 012
- 🔑 06 1088 012

- 🔑 06 1078 023 (ILS)
- 🔑 06 1088 023 (ILS)



- 🔑 07 0809 228 (fixed; aluminium and stainless steel)
- 🔑 07 0809 228 (fixed; stainless steel)
- 🔑 07 0809 428 (fixed; aluminium)



- 🔑 17 1757

* Fire safety and EN 179 variants available only in stainless steel; for variants, see page 508

Lever/knob sets

Broad backplate sets available upon request; for flush-fitted roses, see page 536 f.

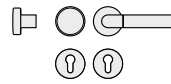

- | | |
|-------------------|-----------------|
| 12 1078 017 (N) | 72 1078 618 (L) |
| 72 1078 617 (R) | 76 1078 618 (L) |
| 76 1078 617 (R) | 79 1088 618 (L) |
| 79 1088 617 (R) | |
| 79 1088 619 (ILS) | |

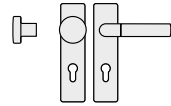

- | | |
|-------------------|-----------------|
| 12 1078 003 (N) | 72 1078 604 (L) |
| 72 1078 603 (R) | 76 1078 604 (L) |
| 76 1078 603 (R) | 79 1088 604 (L) |
| 79 1088 603 (R) | |
| 79 1088 605 (ILS) | |

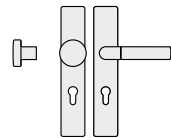

- | | |
|-------------------|-----------------|
| 12 1078 023 (N) | 72 1078 624 (L) |
| 72 1078 623 (R) | 76 1078 624 (L) |
| 76 1078 623 (R) | 79 1088 624 (L) |
| 79 1088 623 (R) | |
| 79 1088 625 (ILS) | |

WC sets

Broad backplate sets available upon request; for flush-fitted roses, see page 536 f.

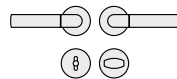

- | | |
|-----------------|-----------------|
| 12 1078 019 (N) | 72 1078 620 (L) |
| 72 1078 619 (R) | |

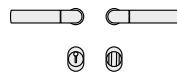

- | |
|-----------------|
| 15 1078 019 (N) |
|-----------------|

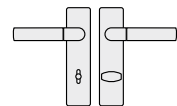

- | | |
|-----------------|-----------------|
| 12 1078 005 (N) | 72 1078 606 (L) |
| 72 1078 605 (R) | |

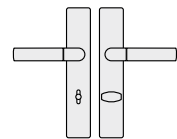

- | | |
|-----------------|-----------------|
| 12 1078 025 (N) | 72 1078 626 (L) |
| 72 1078 625 (R) | |

Window handles



- 34 1078 09030 (rose 27 × 62 × 10)
- 34 1078 09039 (rose 32.5 × 70 × 10)
- 34 1078 09034 (rose 25.5 × 60.5 flush-fitted)
- 34 1078 170 (lock adaptor RC 1–6)
- 34 1078 076 (lock adaptor with push-button RC 1–6)
- 34 1078 711 (plug-in handle for timber/metal profiles, Ø 30)
- 34 1078 751 (plug-in handle for PVC profiles, Ø 30)
- 34 1078 714 (plug-in handle, lock adaptor RC 1–6)
- 34 1078 717 (plug-in handle with push-button RC 1–6)

N = non-handed
 prv = lever handle with privacy function
 R = DIN RH, opening inwards
 L = DIN LH, opening inwards
 ILS = inactive-leaf set

Female handles
 Plug-in handle for doors
 FSB ASL®

FSB AGL®
 FS heavy-duty fitting
 EN 179 heavy-duty fitting

For bearings, see page 52 ff.

Helmut Jahn and Yorgo Lykouria came to door handle design without any preconceptions whatsoever. Freeing their minds of the constraints of industrial production processes, they sought a shape combining geometrical and ergonomic elements. The upshot is a genuine innovation of the moulded-to-the-hand concept.

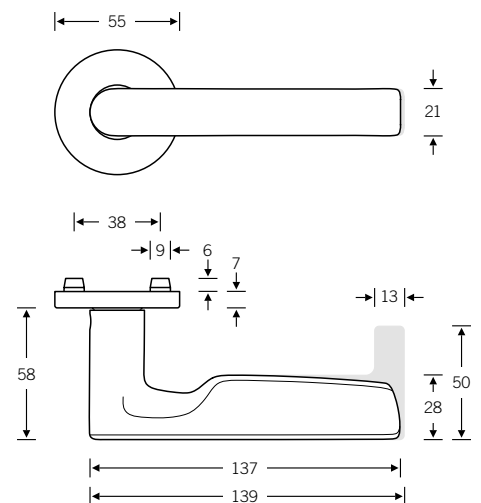

Design: Helmut Jahn, Yorgo Lykouria

 EN 179 model: FSB 1094
 Lever handle with return-to-door

Other variants:
 – square roses
 – oval/angular backplates

Lever handle with privacy function

12 1093

Push-button lock, see page 526 ff.

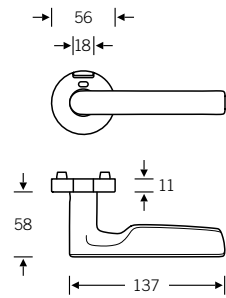

Plug-in handle for doors

15 1093

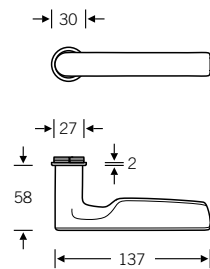

Window handle

Plug-in handle for windows

34 1093

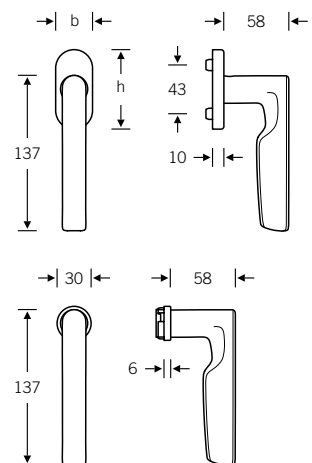

Lever handles for narrow-stile doors

09 1094 (in-line, EN 179)
06 1094 (cranked, EN 179)

Option without return-to-door:
09 1093 (in-line)
06 1093 (cranked)

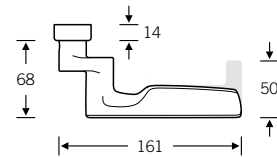
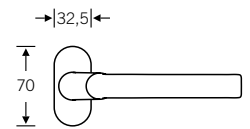
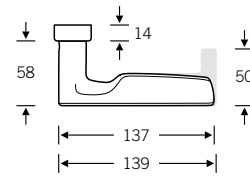
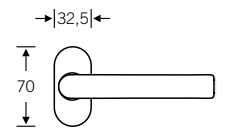

Doorknob for narrow-stile doors

07 0846 (cranked)

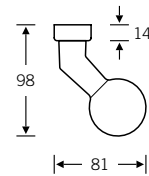
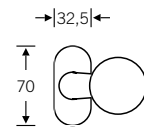

Glass door fitting

13 4223 with 72 1093

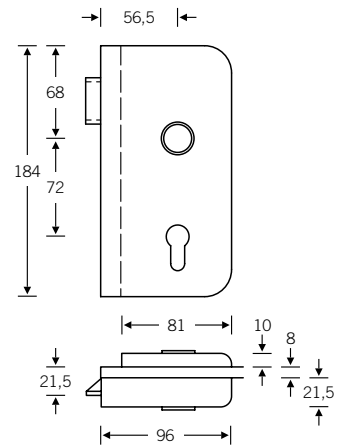

4

Lever/knob sets

Doorknob for flush doors

Knob backplates

Aluminium X = 77 mm
Stainless steel X = 73 mm

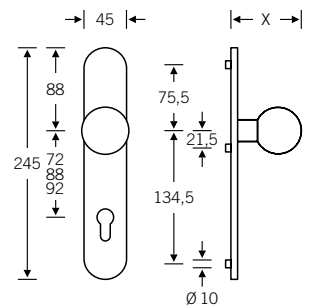
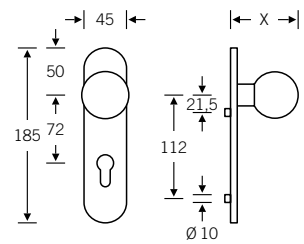
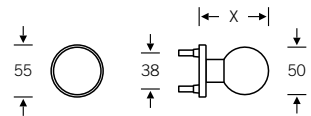

Product codes for the lever/knob sets can be found on the following pages; for individual components, see page 328 ff.

Lever/lever sets

Broad backplate sets available upon request; for flush-fitted roses, see page 386 f.

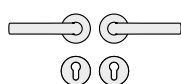

- 12 1093 013 (N)
- 72 1093 613 (R)
- 76 1093 613 (R)
- 79 1094 613 (R)

- 12 1093 047 (prv)
- 72 1093 614 (L)
- 76 1093 614 (L)
- 79 1094 614 (L)

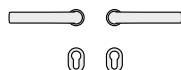

- 15 1093 013 (N)

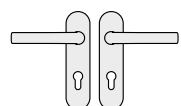

- 12 1093 007 (N)
- 72 1093 607 (R)
- 76 1093 607 (R)
- 79 1094 607 (R)

- 72 1093 608 (L)
- 76 1093 608 (L)
- 79 1094 608 (L)

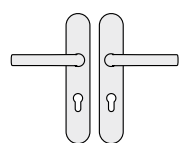

- 12 1093 027 (N)
- 72 1093 627 (R)
- 76 1093 627 (R)
- 79 1094 627 (R)

- 72 1093 628 (L)
- 76 1093 628 (L)
- 79 1094 628 (L)

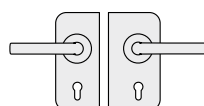

- 13 4223 041 (R) with 10 1093 00500 (N)
- 13 4223 042 (R) with 12 1093 013 (N)
- 13 4223 042 (R) with 72 1093 613 (R)

- 13 4223 051 (L) with 10 1093 00500 (N)
- 13 4223 052 (L) with 12 1093 013 (N)
- 13 4223 052 (L) with 72 1093 614 (L)

Sets for narrow-stile doors

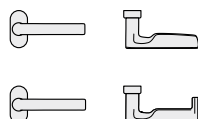

- 09 1093 111
- 09 1093 112 (refit to ILS possible)
- 09 1094 112 (refit to ILS possible)

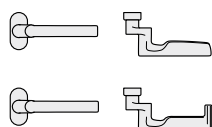

- 06 1093 011
- 06 1093 012
- 06 1094 012

- 06 1093 023 (ILS)
- 06 1094 023 (ILS)



- 07 0846 228 (fixed; aluminium and stainless steel)
- 07 0846 228 (fixed; stainless steel)
- 07 0846 428 (fixed; aluminium)



- 17 1757

Lever/knob sets

Broad backplate sets available upon request

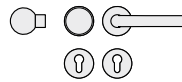

- 12 1093 015 (N)
- 72 1093 615 (R)
- 76 1093 615 (R)
- 79 1094 615 (R)
- 79 1094 619 (ILS)
- 72 1093 616 (L)
- 76 1093 616 (L)
- 79 1094 616 (L)

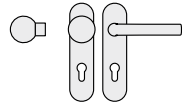

- 12 1093 009 (N)
- 72 1093 609 (R)
- 76 1093 609 (R)
- 79 1094 609 (R)
- 79 1094 611 (ILS)
- 72 1093 610 (L)
- 76 1093 610 (L)
- 79 1094 610 (L)

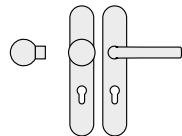

- 12 1093 029 (N)
- 72 1093 629 (R)
- 76 1093 629 (R)
- 79 1094 629 (R)
- 79 1094 631 (ILS)
- 72 1093 630 (L)
- 76 1093 630 (L)
- 79 1094 630 (L)

WC sets

Broad backplate sets available upon request;
for flush-fitted roses, see page 386 f.

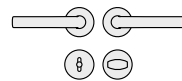

- 12 1093 019 (N)
- 72 1093 619 (R)
- 72 1093 620 (L)

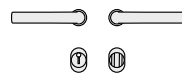

- 15 1093 019 (N)

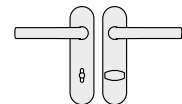

- 12 1093 011 (N)
- 72 1093 611 (R)
- 72 1093 612 (L)

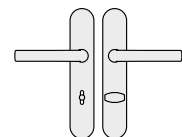

- 12 1093 031 (N)
- 72 1093 631 (R)
- 72 1093 632 (L)

Window handles



- 34 1093 09030 (rose 27 × 62 × 10)
- 34 1093 09039 (rose 32.5 × 70 × 10)
- 34 1093 09034 (rose 25.5 × 60.5 flush-fitted)
- 34 1093 170 (lock adaptor RC 1–6)
- 34 1093 076 (lock adaptor with push-button RC 1–6)
- 34 1093 711 (plug-in handle for timber/metal profiles, Ø 30)
- 34 1093 751 (plug-in handle for PVC profiles, Ø 30)
- 34 1093 714 (plug-in handle, lock adaptor RC 1–6)
- 34 1093 717 (plug-in handle with push-button RC 1–6)

N = non-handed
 prv = lever handle with privacy function
 R = DIN RH, opening inwards
 L = DIN LH, opening inwards
 ILS = inactive-leaf set

Female handles
 Plug-in handle for doors
 FSB ASL®

FSB AGL®
 FS heavy-duty fitting
 EN 179 heavy-duty fitting

For bearings, see page 52 ff.

The FSB 1102 model is rooted in Alessandro Mendini's redesign of the celebrated Gropius lever handle, which he refashioned by using a different material and adding a groove. The remodel was one of his submissions to FSB's Design Workshop held in 1986. We now supply the FSB 1102 in three materials but would recommend using the stainless steel or bronze variants on heavily used doors.

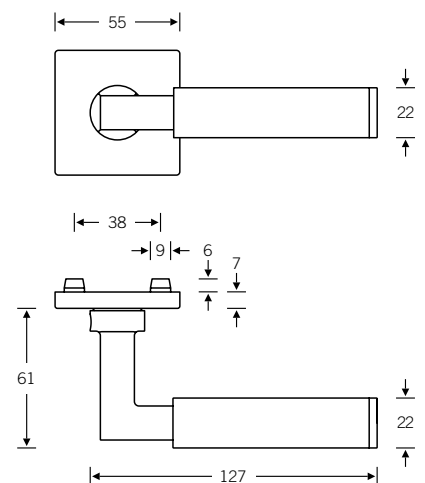
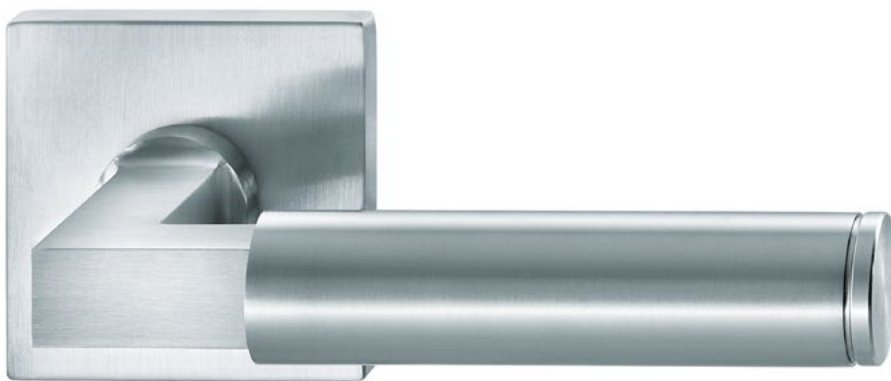

Design: Alessandro Mendini

* Only aluminium 0105 and bronze 7615 available

Other variants:
 – round roses
 – oval/angular backplates

Grip section also available in black blasted aluminium in combination with stainless steel and aluminium

Lever handle with privacy function

12 1102

Push-button lock, see page 526 ff.

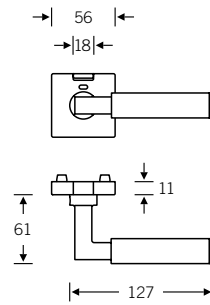
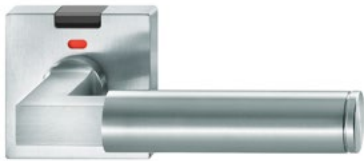

Plug-in handle for doors

15 1102

4

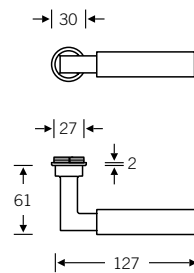

Window handle

Plug-in handle for windows

34 1102

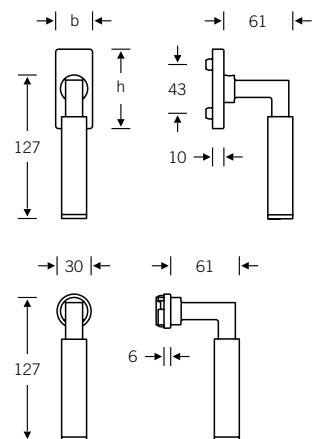

Lifting/sliding door handle

34 1102 021

For more variants, see page 446

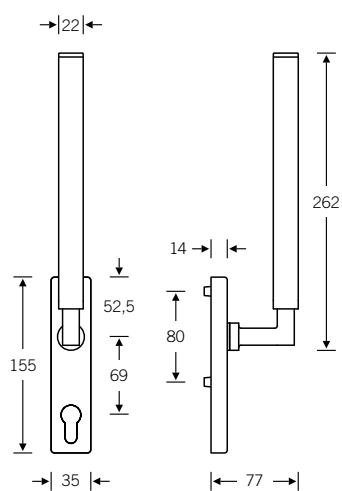

Lever handles
for narrow-stile doors

09 1102 (in-line)

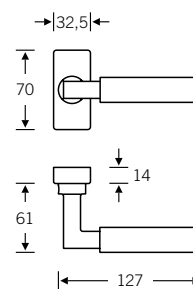

Doorknob
for narrow-stile doors

07 0812 (cranked)

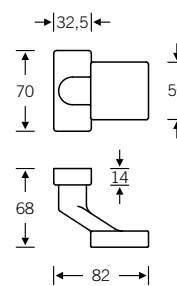

Glass door fitting

13 4220 with 10 1102

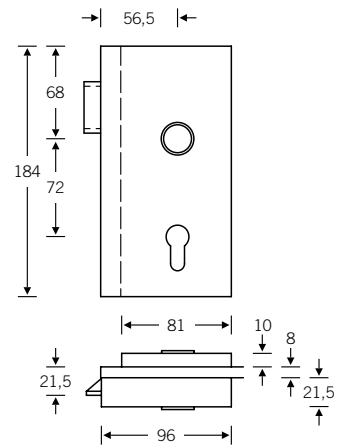

4

Lever/knob sets

Doorknob for flush doors

Knob backplates

- Aluminium $\varnothing = 50$
- Stainless steel $\varnothing = 55$
- Bronze $\varnothing = 50$

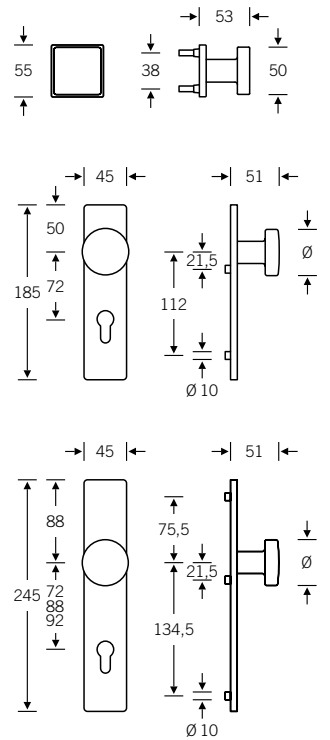

Product codes for the lever/knob sets can be found on the following pages; for individual components, see page 328 ff.

Lever/lever sets

Broad backplate sets available upon request; for flush-fitted roses, see page 536 f.

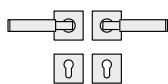

- 🔑 12 1102 041 (N)
- 🔑 72 1102 641 (R)
- 🔑 76 1102 639 (R)

- 🔑 12 1102 049 (prv)
- 🔑 72 1102 642 (L)
- 🔑 76 1102 640 (L)

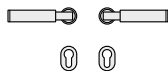

- 🔑 15 1102 013 (N)

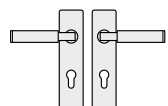

- 🔑 12 1102 001 (N)
- 🔑 72 1102 601 (R)
- 🔑 76 1102 601 (R)

- 🔑 72 1102 602 (L)
- 🔑 76 1102 602 (L)

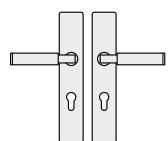

- 🔑 12 1102 021 (N)
- 🔑 72 1102 621 (R)
- 🔑 76 1102 621 (R)

- 🔑 72 1102 622 (L)
- 🔑 76 1102 622 (L)

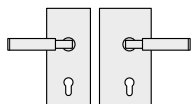

- 🔑 13 4220 041 (R) with 10 1102 00500 (N)
- 🔑 13 4220 042 (R) with 12 1102 041 (N)
- 🔑 13 4220 042 (R) with 72 1102 641 (R)
- 🔑 13 4220 090* with 76 1102 639 (R)

- 🔑 13 4220 052 (L) with 10 1102 00500 (N)
- 🔑 13 4220 052 (L) with 12 1102 041 (N)
- 🔑 13 4220 052 (L) with 72 1102 642 (L)
- 🔑 13 4220 090* with 76 1102 640 (L)

Sets for narrow-stile doors

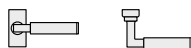

- 🔑 09 1102 171
- 🔑 09 1102 172 (refit to ILS possible)



- 07 0812 229 (fixed; aluminium, stainless steel and bronze)
- 🔑 07 0812 229 (fixed; stainless steel and bronze)
- 🔑 07 0812 429 (fixed; aluminium)



- 17 1778

* Fire safety variant available only in stainless steel; for variants, see page 508

Heavy-duty, fire safety fittings only in stainless steel and bronze

Lever/knob sets

Broad backplate sets available upon request;
for flush-fitted roses, see page 536 f.



- 12 1102 043 (N)
- 72 1102 643 (R)
- 76 1102 641 (R)
- 72 1102 644 (L)
- 76 1102 642 (L)

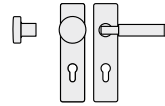

- 12 1102 003 (N)
- 72 1102 603 (R)
- 76 1102 603 (R)
- 72 1102 604 (L)
- 76 1102 604 (L)

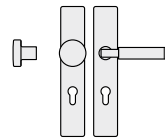

- 12 1102 023 (N)
- 72 1102 623 (R)
- 76 1102 623 (R)
- 72 1102 624 (L)
- 76 1102 624 (L)

WC sets

Broad backplate sets available upon request;
for flush-fitted roses, see page 536 f.

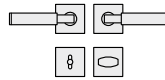

- 12 1102 045 (N)
- 72 1102 645 (R)
- 72 1102 646 (L)

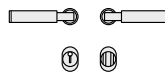

- 15 1102 019 (N)

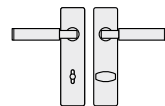

- 12 1102 005 (N)
- 72 1102 605 (R)
- 72 1102 606 (L)

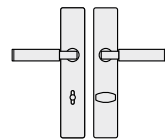

- 12 1102 025 (N)
- 72 1102 625 (R)
- 72 1102 626 (L)

Window handles

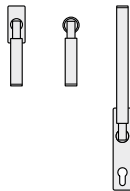

- 34 1102 09032 (rose 27 × 62 × 10)
- 34 1102 09040 (rose 32.5 × 70 × 10)
- 34 1102 09036 (rose 25.5 × 60.5 flush-fitted)
- 34 1102 180 (lock adaptor RC 1–6)
- 34 1102 086 (lock adaptor with push-button RC 1–6)
- 34 1102 711 (plug-in handle for timber/metal profiles, Ø 30)
- 34 1102 751 (plug-in handle for PVC profiles, Ø 30)
- 34 1102 021 (lifting/sliding door handle)

N = non-handed
 prv = lever handle with privacy function
 R = DIN RH, opening inwards
 L = DIN LH, opening inwards
 ILS = inactive-leaf set

Female handles
 Plug-in handle for doors
 FSB ASL®

FSB AGL®
 FS heavy-duty fitting
 EN 179 heavy-duty fitting

For bearings, see page 52 ff.

The FSB 1106 is characterised by the way it marries traditional styling to a wide range of classic hardware materials. It echoes the formal properties of its little brother, the FSB 1135. Technically speaking, though, it has had an FSB compensating bearing added in order to meet the requirements for FSB AGL® and FSB AGL® FS heavy-duty fittings.

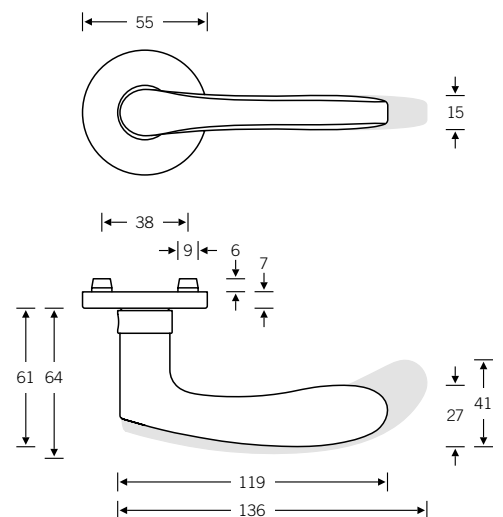

Design: Christoph Mäckler

EN 179 model: FSB 1043
Lever handle with return-to-door

Other variants:
– square roses
– oval/angular backplates

Lever handle with privacy function

12 1106

Push-button lock, see page 526 ff.

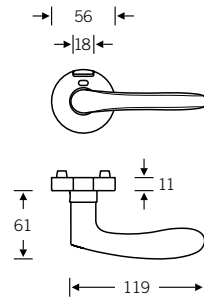

Plug-in handle for doors

15 1106

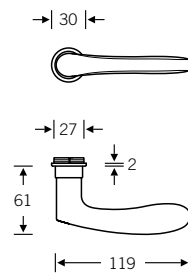

Window handle

Plug-in handle for windows

34 1106

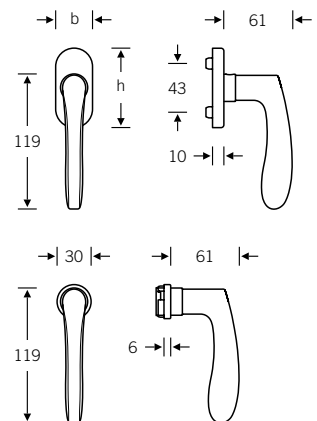

Lever handles for narrow-stile doors

09 1043 (in-line, EN 179)
06 1043 (cranked, EN 179)

Option without return-to-door:
09 1106 (in-line)

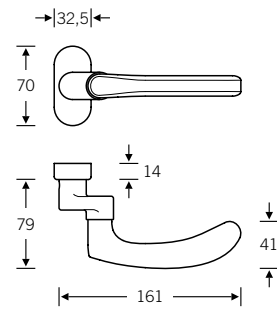
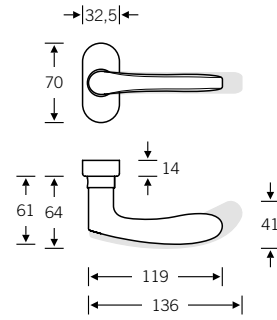

Doorknob for narrow-stile doors

07 0846 (cranked)

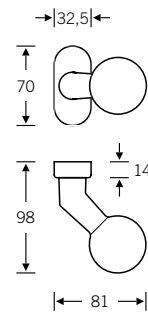

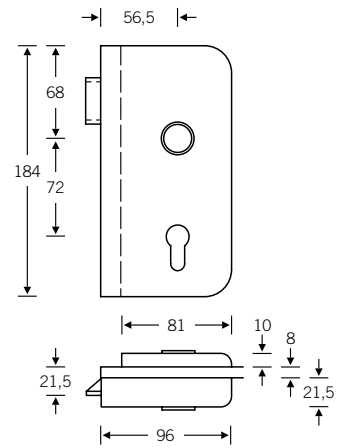

Lever/knob sets

Doorknob for flush doors

Knob backplates

- Aluminium X = 77 mm
- Stainless steel X = 73 mm
- Bronze X = 72 mm

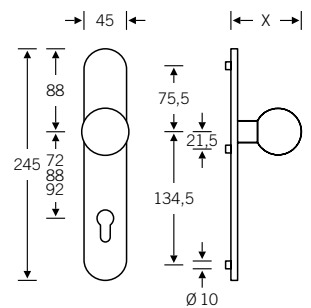
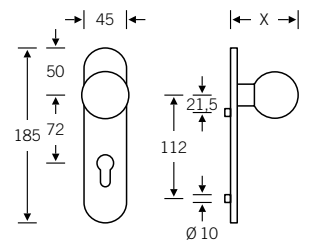
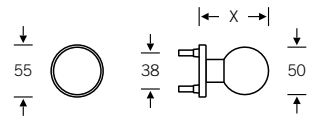

Product codes for the lever/knob sets can be found on the following pages; for individual components, see page 328 ff.

Lever/lever sets

Broad backplate sets available upon request; for flush-fitted roses, see page 536 f.

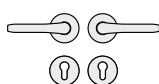

- 🔑 12 1106 013 (N)
- 🔑 72 1106 613 (R)
- 🔑 76 1106 613 (R)
- 🔑 79 1043 613 (R)

- 🔑 12 1106 047 (prv)
- 🔑 72 1106 614 (L)
- 🔑 76 1106 614 (L)
- 🔑 79 1043 614 (L)

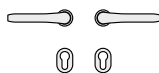

- 🔑 15 1106 013 (N)

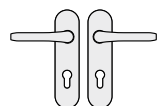

- 🔑 12 1106 007 (N)
- 🔑 72 1106 607 (R)
- 🔑 76 1106 607 (R)
- 🔑 79 1043 607 (R)

- 🔑 72 1106 608 (L)
- 🔑 76 1106 608 (L)
- 🔑 79 1043 608 (L)

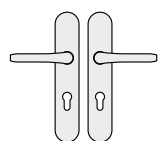

- 🔑 12 1106 027 (N)
- 🔑 72 1106 627 (R)
- 🔑 76 1106 627 (R)
- 🔑 79 1043 627 (R)

- 🔑 72 1106 628 (L)
- 🔑 76 1106 628 (L)
- 🔑 79 1043 628 (L)

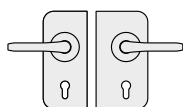

- 🔑 13 4223 041 (R) with 10 1106 00500 (N)
- 🔑 13 4223 042 (R) with 12 1106 013 (N)
- 🔑 13 4223 042 (R) with 72 1106 613 (R)

- 🔑 13 4223 051 (L) with 10 1106 00500 (N)
- 🔑 13 4223 052 (L) with 12 1106 013 (N)
- 🔑 13 4223 052 (L) with 72 1106 614 (L)

Sets for narrow-stile doors

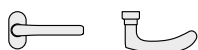

- 🔑 09 1106 111
- 🔑 09 1106 112 (refit to ILS possible)
- 🔑 09 1043 112 (refit to ILS possible)

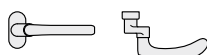

- 🔑 06 1043 012

- 🔑 06 1043 023 (ILS)



- 07 0846 228 (fixed; aluminium, stainless steel and bronze)
- 🔑 07 0846 228 (fixed; stainless steel and bronze)
- 🔑 07 0846 428 (fixed; aluminium)



- 17 1757

Lever/knob sets

Broad backplate sets available upon request; for flush-fitted roses, see page 536 f.

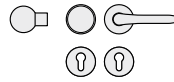

- 12 1106 015 (N)
- 72 1106 615 (R)
- 76 1106 615 (R)
- 79 1043 615 (R)
- 79 1043 619 (ILS)
- 72 1106 616 (L)
- 76 1106 616 (L)
- 79 1043 616 (L)

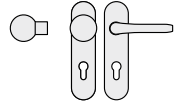

- 12 1106 009 (N)
- 72 1106 609 (R)
- 76 1106 609 (R)
- 79 1043 609 (R)
- 79 1043 611 (ILS)
- 72 1106 610 (L)
- 76 1106 610 (L)
- 79 1043 610 (L)

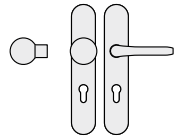

- 12 1106 029 (N)
- 72 1106 629 (R)
- 76 1106 629 (R)
- 79 1043 629 (R)
- 79 1043 631 (ILS)
- 72 1106 630 (L)
- 76 1106 630 (L)
- 79 1043 630 (L)

WC sets

Broad backplate sets available upon request; for flush-fitted roses, see page 536 f.

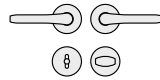

- 12 1106 019 (N)
- 72 1106 619 (R)
- 72 1106 620 (L)

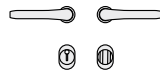

- 15 1106 019 (N)

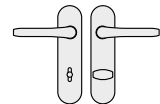

- 12 1106 011 (N)
- 72 1106 611 (R)
- 72 1106 612 (L)

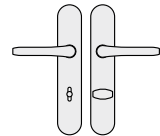

- 12 1106 031 (N)
- 72 1106 631 (R)
- 72 1106 632 (L)

Window handles



- 34 1106 09030 (rose 27 × 62 × 10)
- 34 1106 09039 (rose 32.5 × 70 × 10)
- 34 1106 09034 (rose 25.5 × 60.5 flush-fitted)
- 34 1106 170 (lock adaptor RC 1–6)
- 34 1106 076 (lock adaptor with push-button RC 1–6)
- 34 1106 711 (plug-in handle for timber/metal profiles, Ø 30)
- 34 1106 751 (plug-in handle for PVC profiles, Ø 30)

N = non-handed
 prv = lever handle with privacy function
 R = DIN RH, opening inwards
 L = DIN LH, opening inwards
 ILS = inactive-leaf set

Female handles
 Plug-in handle for doors
 FSB ASL®

FSB AGL®
 FS heavy-duty fitting
 EN 179 heavy-duty fitting

For bearings, see page 52 ff.

The FSB 1107 is related to the FSB 1108. FSB's in-house designer Hartmut Weise has imbued his 'Brakel Lightweight' with the curve of a door in motion. His lever handles for narrow-stile doors were soon joined by the FSB 1177 variant with a return-to-door.

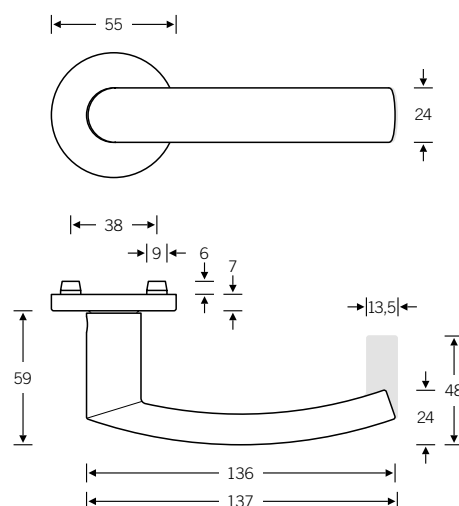

Design: Hartmut Weise

 EN 179 model: FSB 1177
Lever handle with return-to-door

Other variants:
– square roses
– oval/angular backplates

Lever handle with privacy function

12 1107

Push-button lock, see page 526 ff.

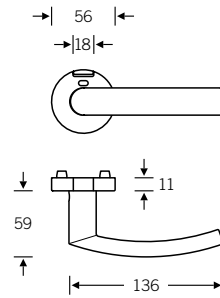

Plug-in handle for doors

15 1107

4

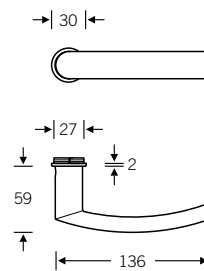

Window handle

Plug-in handle for windows

34 1107

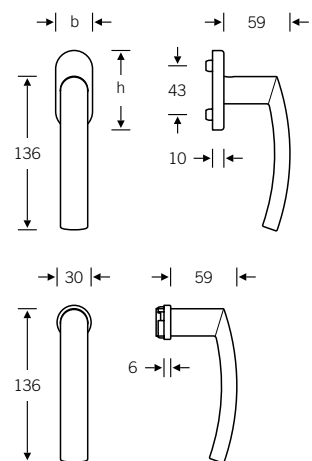
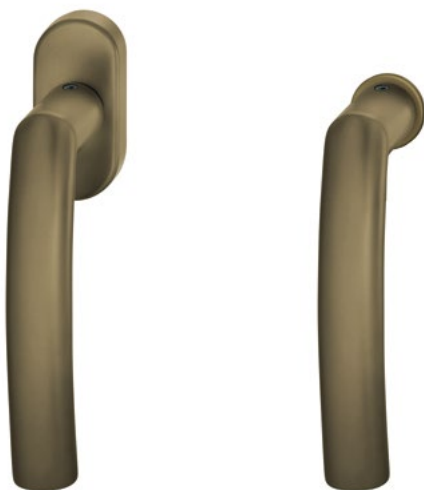

Lever handles for narrow-stile doors

09 1177 (in-line, EN 179)
06 1177 (cranked, EN 179)

Option without return-to-door:
09 1107 (in-line)
06 1107 (cranked)

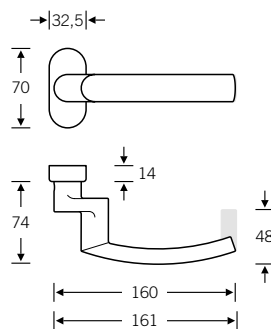
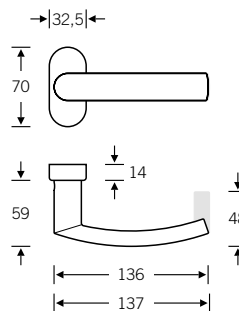

Doorknob for narrow-stile doors

07 0846 (cranked)

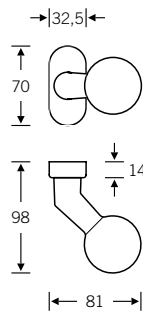

Glass door fitting

13 4223 with 72 1107

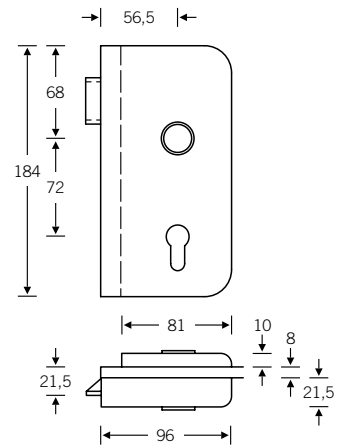

4

Lever/knob sets

Doorknob for flush doors

Knob backplates

Aluminium X = 77 mm
Stainless steel X = 73 mm

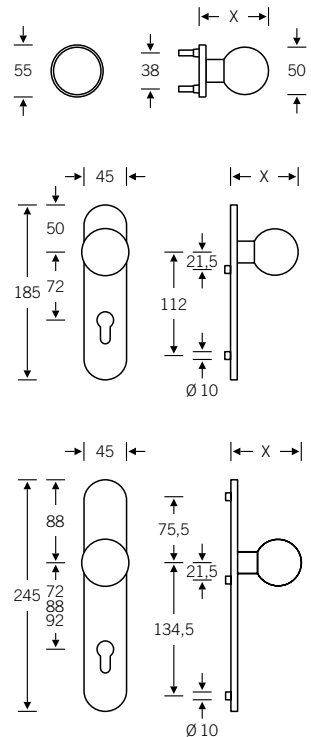
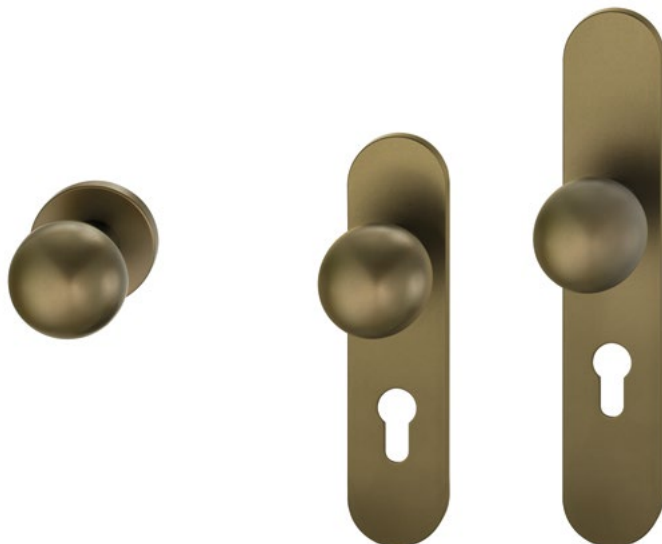

Product codes for the lever/knob sets can be found on the following pages; for individual components, see page 328 ff.

Lever/lever sets

Broad backplate sets available upon request; for flush-fitted roses, see page 536 f.

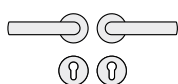

- 🔑 12 1107 013 (N)
- 🔑 72 1107 613 (R)
- 🔑 76 1107 613 (R)
- 🔑 79 1177 613 (R)

- 🔑 12 1107 047 (prv)
- 🔑 72 1107 614 (L)
- 🔑 76 1107 614 (L)
- 🔑 79 1177 614 (L)

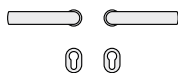

- 🔑 15 1107 013 (N)

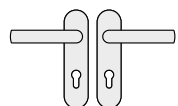

- 🔑 12 1107 007 (N)
- 🔑 72 1107 607 (R)
- 🔑 76 1107 607 (R)
- 🔑 79 1177 607 (R)

- 🔑 72 1107 608 (L)
- 🔑 76 1107 608 (L)
- 🔑 79 1177 608 (L)

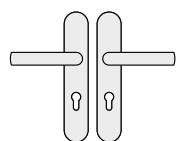

- 🔑 12 1107 027 (N)
- 🔑 72 1107 627 (R)
- 🔑 76 1107 627 (R)
- 🔑 79 1177 627 (R)

- 🔑 72 1107 628 (L)
- 🔑 76 1107 628 (L)
- 🔑 79 1177 628 (L)

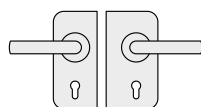

- 🔑 13 4223 041 (R) with 10 1107 00500 (N)
- 🔑 13 4223 042 (R) with 12 1107 013 (N)
- 🔑 13 4223 042 (R) with 72 1107 613 (R)

- 🔑 13 4223 051 (L) with 10 1107 00500 (N)
- 🔑 13 4223 052 (L) with 12 1107 013 (N)
- 🔑 13 4223 052 (L) with 72 1107 614 (L)

Sets for narrow-stile doors

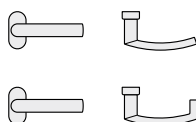

- 🔑 09 1107 111
- 🔑 09 1107 112 (refit to ILS possible)
- 🔑 09 1177 112 (refit to ILS possible)

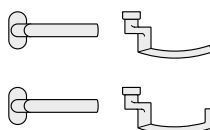

- 🔑 06 1107 011
- 🔑 06 1107 012
- 🔑 06 1177 012

- 🔑 06 1107 023 (ILS)
- 🔑 06 1177 023 (ILS)



- 07 0846 228 (fixed; aluminium and stainless steel)
- 🔑 07 0846 228 (fixed; stainless steel)
- 🔑 07 0846 428 (fixed; aluminium)



- 17 1757

Lever/knob sets

Broad backplate sets available upon request; for flush-fitted roses, see page 536 f.

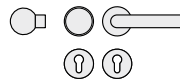

- | | |
|-----------------|-------------------|
| 12 1107 015 (N) | 72 1107 616 (L) |
| 72 1107 615 (R) | 76 1107 615 (R) |
| 76 1107 615 (R) | 79 1177 615 (R) |
| 79 1177 615 (R) | 79 1177 619 (ILS) |
| | 72 1107 616 (L) |
| | 76 1107 616 (L) |
| | 79 1177 616 (L) |

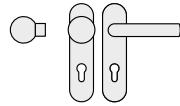

- | | |
|-----------------|-------------------|
| 12 1107 009 (N) | 72 1107 610 (L) |
| 72 1107 609 (R) | 76 1107 609 (R) |
| 76 1107 609 (R) | 79 1177 609 (R) |
| 79 1177 609 (R) | 79 1177 611 (ILS) |
| | 72 1107 610 (L) |
| | 76 1107 610 (L) |
| | 79 1177 610 (L) |

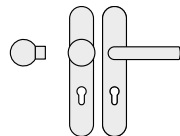

- | | |
|-----------------|-------------------|
| 12 1107 029 (N) | 72 1107 630 (L) |
| 72 1107 629 (R) | 76 1107 629 (R) |
| 76 1107 629 (R) | 79 1177 629 (R) |
| 79 1177 629 (R) | 79 1177 631 (ILS) |
| | 72 1107 630 (L) |
| | 76 1107 630 (L) |
| | 79 1177 630 (L) |

WC sets

Broad backplate sets available upon request; for flush-fitted roses, see page 536 f.

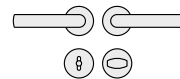

- | | |
|-----------------|-----------------|
| 12 1107 019 (N) | 72 1107 620 (L) |
| 72 1107 619 (R) | |

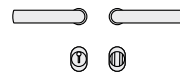

- | |
|-----------------|
| 15 1107 019 (N) |
|-----------------|

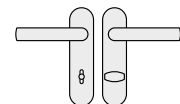

- | | |
|-----------------|-----------------|
| 12 1107 011 (N) | 72 1107 612 (L) |
| 72 1107 611 (R) | |

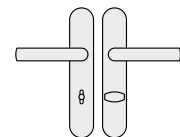

- | | |
|-----------------|-----------------|
| 12 1107 031 (N) | 72 1107 632 (L) |
| 72 1107 631 (R) | |

Window handles



- 34 1107 09030 (rose 27 × 62 × 10)
- 34 1107 09039 (rose 32.5 × 70 × 10)
- 34 1107 09034 (rose 25.5 × 60.5 flush-fitted)
- 34 1107 170 (lock adaptor RC 1–6)
- 34 1107 076 (lock adaptor with push-button RC 1–6)
- 34 1107 711 (plug-in handle for timber/metal profiles, Ø 30)
- 34 1107 751 (plug-in handle for PVC profiles, Ø 30)

N = non-handed
 prv = lever handle with privacy function
 R = DIN RH, opening inwards
 L = DIN LH, opening inwards
 ILS = inactive-leaf set

Female handles
 Plug-in handle for doors
 FSB ASL®

FSB AGL®
 FS heavy-duty fitting
 EN 179 heavy-duty fitting

For bearings, see page 52 ff.

Our in-house designer Hartmut Weise was musing over what it is that gives the 'Frankfurt model' and 'Wittgenstein's handle' their particular appeal. It was their 'unpretentious look,' he concluded. He then set out to offer the market an unostentatious design that was at the very least on a par with them. The upshot was the FSB 1108 – a round tube coupled with a mitred grip section with an oval cross-section. Could this be the 'Brakel model'?

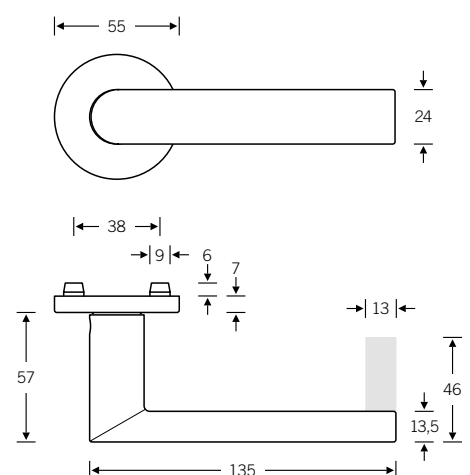

Design: Hartmut Weise

EN 179 model: FSB 1178
Lever handle with return-to-door

Other variants:
– square roses
– oval/angular backplates

Lever handle with privacy function

12 1108

Push-button lock, see page 526 ff.

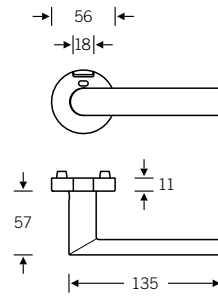

Plug-in handle for doors

15 1108

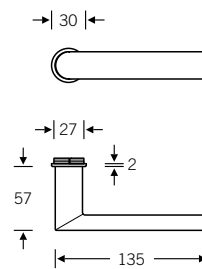

Window handle

Plug-in handle for windows

34 1108

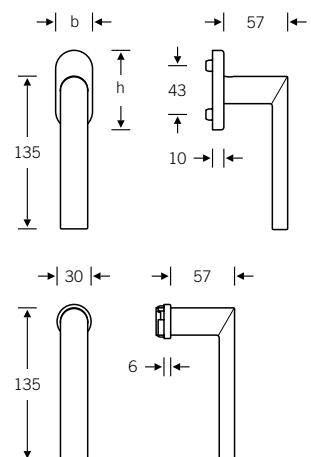

Custom-coordinated lifting/sliding door handle available upon request, see page 10

Lever handles for narrow-stile doors

09 1178 (in-line, EN 179)
06 1178 (cranked, EN 179)

Option without return-to-door:
09 1108 (in-line)
06 1108 (cranked)

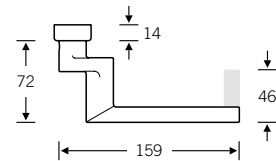
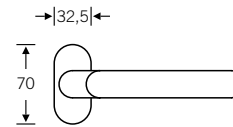
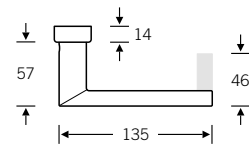
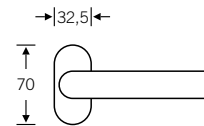

Doorknob for narrow-stile doors

07 0846 (cranked)

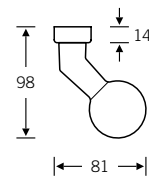
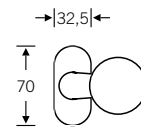

Glass door fitting

13 4223 with 72 1108

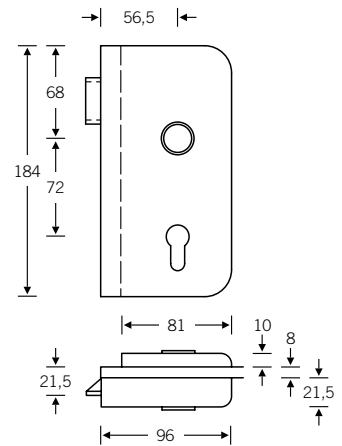

4

Lever/knob sets

Doorknob for flush doors

Knob backplates

Aluminium X = 77 mm
Stainless steel X = 73 mm

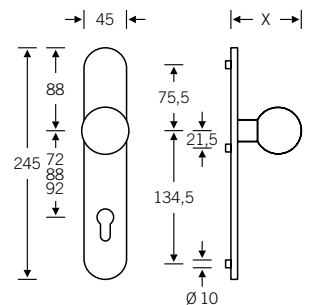
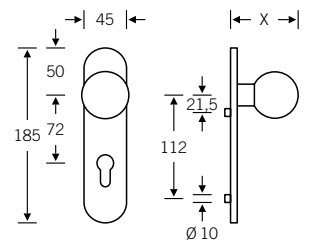
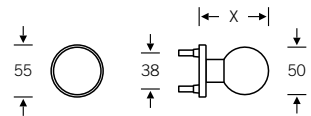

Product codes for the lever/knob sets can be found on the following pages; for individual components, see page 328 ff.

Lever/lever sets

Broad backplate sets available upon request; for flush-fitted roses, see page 536 f.

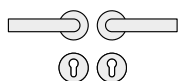

- 12 1108 013 (N)
- 72 1108 613 (R)
- 76 1108 613 (R)
- 79 1178 613 (R)

- 12 1108 047 (prv)
- 72 1108 614 (L)
- 76 1108 614 (L)
- 79 1178 614 (L)

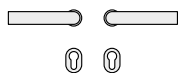

- 15 1108 013 (N)

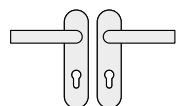

- 12 1108 007 (N)
- 72 1108 607 (R)
- 76 1108 607 (R)
- 79 1178 607 (R)

- 72 1108 608 (L)
- 76 1108 608 (L)
- 79 1178 608 (L)

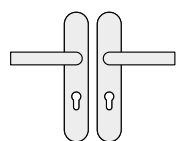

- 12 1108 021 (N)
- 72 1108 627 (R)
- 76 1108 627 (R)
- 79 1178 627 (R)

- 72 1108 628 (L)
- 76 1108 628 (L)
- 79 1178 628 (L)

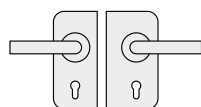

- 13 4223 041 (R) with 10 1108 00500 (N)
- 13 4223 042 (R) with 12 1108 013 (N)
- 13 4223 042 (R) with 72 1108 613 (R)

- 13 4223 051 (L) with 10 1108 00500 (N)
- 13 4223 052 (L) with 12 1108 013 (N)
- 13 4223 052 (L) with 72 1108 614 (L)

Sets for narrow-stile doors

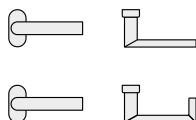

- 09 1108 111
- 09 1108 112 (refit to ILS possible)
- 09 1178 112 (refit to ILS possible)

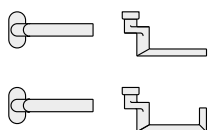

- 06 1108 011
- 06 1108 012
- 06 1178 012
- 06 1108 023 (ILS)
- 06 1178 023 (ILS)



- 07 0846 228 (fixed; aluminium and stainless steel)
- 07 0846 228 (fixed; stainless steel)
- 07 0846 428 (fixed; aluminium)



- 17 1757

Lever/knob sets

Broad backplate sets available upon request; for flush-fitted roses, see page 536 f.

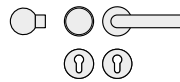

- | | |
|-----------------|-------------------|
| 12 1108 015 (N) | 72 1108 616 (L) |
| 72 1108 615 (R) | 76 1108 615 (R) |
| 76 1108 615 (R) | 79 1178 615 (R) |
| 79 1178 615 (R) | 79 1178 619 (ILS) |

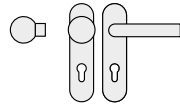

- | | |
|-----------------|-------------------|
| 12 1108 009 (N) | 72 1108 610 (L) |
| 72 1108 609 (R) | 76 1108 609 (R) |
| 76 1108 609 (R) | 79 1178 609 (R) |
| 79 1178 609 (R) | 79 1178 611 (ILS) |

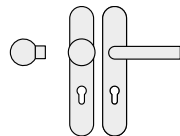

- | | |
|-----------------|-------------------|
| 12 1108 029 (N) | 72 1108 630 (L) |
| 72 1108 629 (R) | 76 1108 629 (R) |
| 76 1108 629 (R) | 79 1178 629 (R) |
| 79 1178 629 (R) | 79 1178 631 (ILS) |

WC sets

Broad backplate sets available upon request; for flush-fitted roses, see page 536 f.

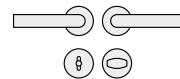

- | | |
|-----------------|-----------------|
| 12 1108 019 (N) | 72 1108 620 (L) |
| 72 1108 619 (R) | |

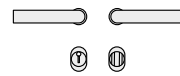

- | |
|-----------------|
| 15 1108 019 (N) |
|-----------------|

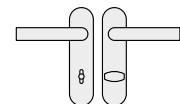

- | | |
|-----------------|-----------------|
| 12 1108 011 (N) | 72 1108 612 (L) |
| 72 1108 611 (R) | |

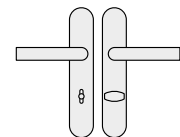

- | | |
|-----------------|-----------------|
| 12 1108 031 (N) | 72 1108 632 (L) |
| 72 1108 631 (R) | |

Window handles

Custom-coordinated lifting/sliding door handle available upon request, see page 10



- 34 1108 09030 (rose 27 × 62 × 10)
- 34 1108 09039 (rose 32.5 × 70 × 10)
- 34 1108 09034 (rose 25.5 × 60.5 flush-fitted)
- 34 1108 170 (lock adaptor RC 1–6)
- 34 1108 076 (lock adaptor with push-button RC 1–6)
- 34 1108 711 (plug-in handle for timber/metal profiles, Ø 30)
- 34 1108 751 (plug-in handle for PVC profiles, Ø 30)
- 34 1108 714 (plug-in handle, lock adaptor RC 1–6)
- 34 1108 717 (plug-in handle with push-button RC 1–6)

N = non-handed
 prv = lever handle with privacy function
 R = DIN RH, opening inwards
 L = DIN LH, opening inwards
 ILS = inactive-leaf set

Female handles
 Plug-in handle for doors
 FSB ASL®

FSB AGL®
 FS heavy-duty fitting
 EN 179 heavy-duty fitting

For bearings, see page 52 ff.

The FSB 1119 incorporates insights gained by FSB in cooperation with the Fraunhofer institute (FSB 1155). Whereas the utmost importance was given to the rigorous implementation of ergonomic parameters for the FSB 1155, considerations of style predominated in the case of the FSB 1119.

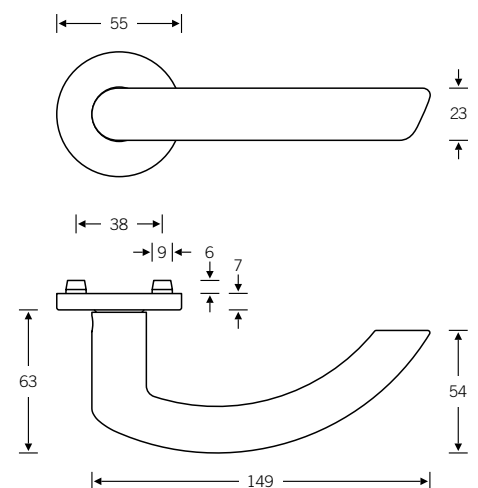

Design: Hartmut Weise
 Pictured: right-hand model

 EN 179 model:
 Lever handle with return-to-door

Other variants:
 – square roses
 – oval/angular backplates

Lever handle with privacy function

12 1119

Push-button lock, see page 526 ff.

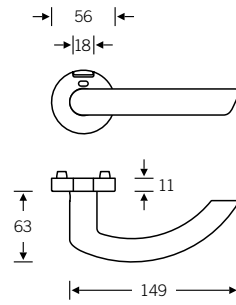

Plug-in handle for doors

15 1119

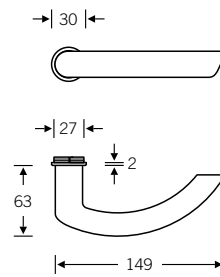

Window handle

Plug-in handle for windows

34 1107

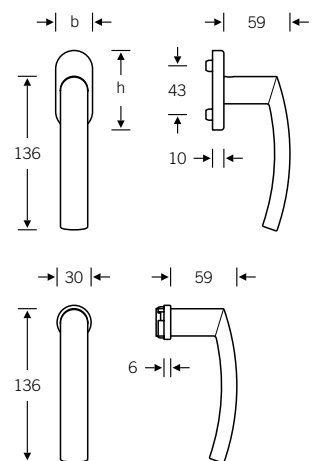

Lever handles for narrow-stile doors

09 1119 (in-line, EN 179)
06 1119 (cranked, EN 179)

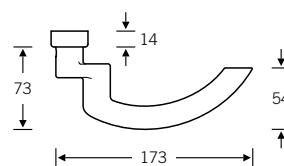
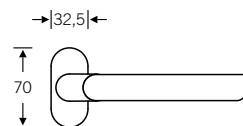
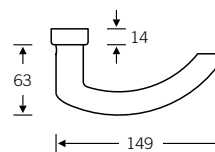
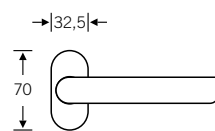

Doorknob for narrow-stile doors

07 0846 (cranked)

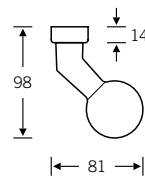
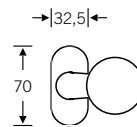

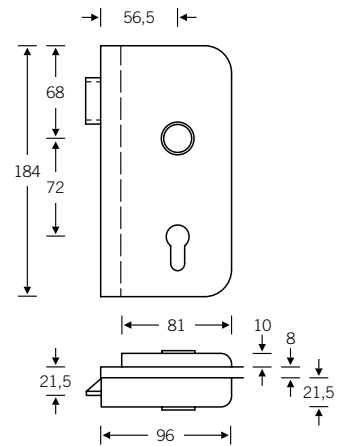

Lever/knob sets

Doorknob for flush doors

Knob backplates

- Aluminium X = 77 mm
- Stainless steel X = 73 mm
- Bronze X = 72 mm

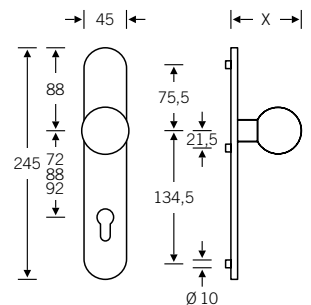
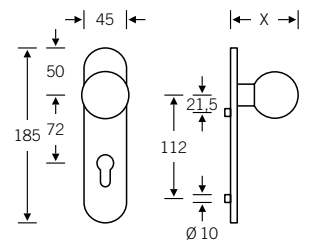
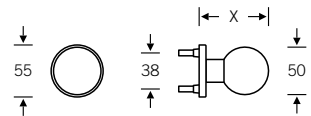





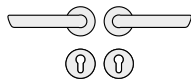

Product codes for the lever/knob sets can be found on the following pages; for individual components, see page 328 ff.

Lever/lever sets

Broad backplate sets available upon request;
for flush-fitted roses, see page 386 f.





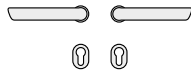

 12 1119 013 (N)
 72 1119 613 (R)
 79 1119 613 (R)

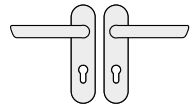

 12 1119 047 (prv)
 72 1119 614 (L)
 79 1119 614 (L)







 15 1119 013 (N)



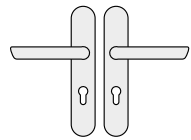

 12 1119 007 (N)
 72 1119 607 (R)
 79 1119 607 (R)



 72 1119 608 (L)
 79 1119 608 (L)



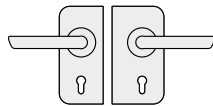

 12 1119 027 (N)
 72 1119 627 (R)
 79 1119 627 (R)

 72 1119 628 (L)
 79 1119 628 (L)









 13 4223 041 (R) with
10 1119 00500 (N)
 13 4223 042 (R) with
12 1119 013 (N)
 13 4223 042 (R) with
72 1119 613 (R)

 13 4223 051 (L) with
10 1119 00500 (N)
 13 4223 052 (L) with
12 1119 013 (N)
 13 4223 052 (L) with
72 1119 614 (L)



Sets for narrow-stile doors





 09 1119 11144 (R)
 09 1119 11264 (R)*
 09 1119 12364 (ILS, R)



 09 1119 11145 (L)
 09 1119 11265 (L)*
 09 1119 12365 (ILS, L)



 06 1119 01144 (R)
 06 1119 01264 (R)
 06 1119 02364 (ILS, R)

 06 1119 01145 (L)
 06 1119 01265 (L)
 06 1119 02365 (ILS, L)



 07 0846 228 (fixed; aluminium, stainless steel and
bronze)
 07 0846 228 (fixed; stainless steel and bronze)
 07 0846 428 (fixed; aluminium)



17 1757

* Refit to ILS possible

Lever/knob sets

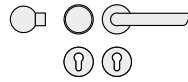

12 1119 015 (R)
 72 1119 615 (R)
 79 1119 615 (R)
 79 1119 619 (ILS)

12 1119 016 (L)
 72 1119 616 (L)
 79 1119 616 (L)

Broad backplate sets available upon request

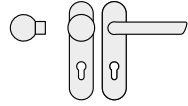

12 1119 009 (R)
 72 1119 609 (R)
 79 1119 609 (R)
 79 1119 611 (ILS)

12 1119 010 (L)
 72 1119 610 (L)
 79 1119 610 (L)

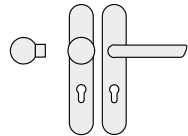

12 1119 029 (R)
 72 1119 629 (R)
 79 1119 629 (R)
 79 1119 631 (ILS)

12 1119 030 (L)
 72 1119 630 (L)
 79 1119 630 (L)

WC sets

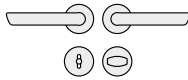

12 1119 019 (N)
 72 1119 619 (R)

72 1119 620 (L)

Broad backplate sets available upon request;
for flush-fitted roses, see page 386 f.

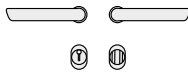

15 1119 019 (N)

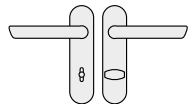

12 1119 011 (N)
 72 1119 611 (R)

72 1119 612 (L)

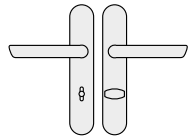

12 1119 031 (N)
 72 1119 631 (R)

72 1119 632 (L)

Window handles



34 1107 09030 (rose 27 × 62 × 10)
 34 1107 09039 (rose 32.5 × 70 × 10)
 34 1107 09034 (rose 25.5 × 60.5 flush-fitted)
 34 1107 170 (lock adaptor RC 1–6)
 34 1107 076 (lock adaptor with push-button RC 1–6)
 34 1107 711 (plug-in handle for timber/metal profiles,
 Ø 30)
 34 1107 751 (plug-in handle for PVC profiles, Ø 30)

N = non-handed
 prv = lever handle with privacy function
 R = DIN RH, opening inwards
 L = DIN LH, opening inwards
 ILS = inactive-leaf set

Female handles
 Plug-in handle for doors
 FSB ASL®

FSB AGL®
 FS heavy-duty fitting
 EN 179 heavy-duty fitting

For bearings, see page 52 ff.

What makes this door handle so appealing is its traditional style. Add the emphatically technical visuals of its backplate and you have a no-frills design solution for any door. A matching heavy-duty companion, the FSB 1106, is available in the classic FSB metals (see page 178).

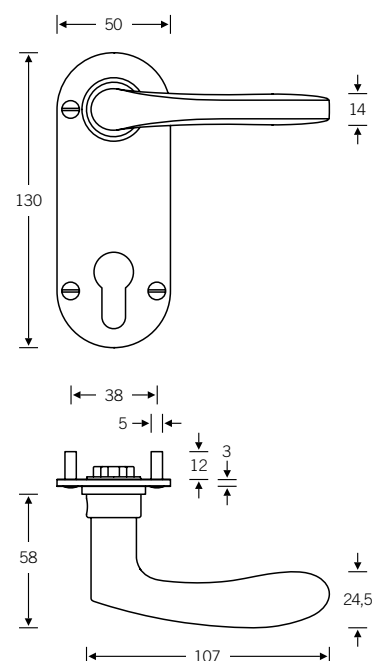

Design: Christoph Mäckler

Other variants:
– round roses
– square roses
– oval/angular backplates

Lever handle with privacy function

12 1106

Push-button lock, see page 526 ff.

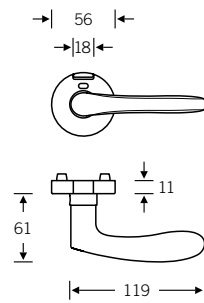

Plug-in handle for doors

15 1135

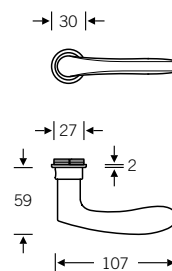

Window handle

Plug-in handle for windows

34 1135
34 1106

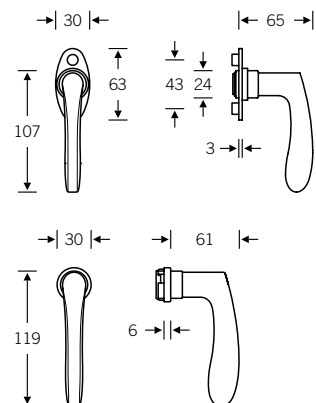

Lever/lever sets

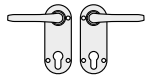

↶ 10 1135 | 14 1425 100 ↷ 12 1106 047 (prv)

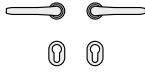

↶ 15 1135 013 (N)

Lever/knob sets

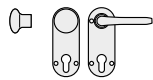

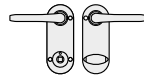

↶ 10 1135 | 14 1425 100 | 19 1925 000

WC sets

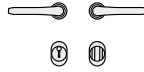

 10 1135 | 14 1425 17554





 15 1135 019 (N)



Window handles



34 1135 000 (flat oval rose)
34 1135 170 (lock adaptor RC 1–6)
34 1135 076 (lock adaptor, with push-button RC 1–6)
34 1106 711 (plug-in handle for timber/metal profiles,
Ø 30)
34 1106 751 (plug-in handle for PVC profiles, Ø 30)

N = non-handed
prv = lever handle with privacy function
R = DIN RH, opening inwards
L = DIN LH, opening inwards
ILS = inactive-leaf set

 Female handles
 Plug-in handle for doors
 FSB ASL®

 FSB AGL®
 FS heavy-duty fitting
 EN 179 heavy-duty fitting

For bearings, see page 52 ff.

The FSB 1144 door handle is just as pleasing to the eye as it is to the hand. Jasper Morrison designed this door handle to be instantly recognisable as a tool meant for the hand. Your eyes relax and your hand takes over. Your thumb falls into place, your forefinger finds its hollow and your hand finds something substantial to grasp. This is precisely what the 'Four-Point Guide to Good Grip' drawn up by FSB and Otl Aicher calls for.

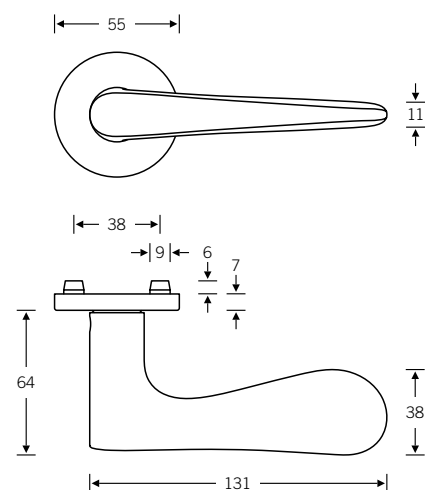

Design: Jasper Morrison

Other variants:
 – square roses
 – oval/angular backplates

Lever handle with privacy function

12 1144

Push-button lock, see page 526 ff.

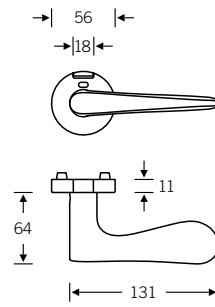

Plug-in handle for doors

15 1144

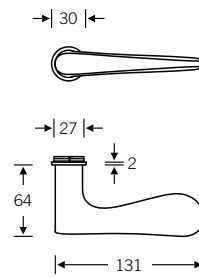

Window handle

Plug-in handle for windows

34 1144

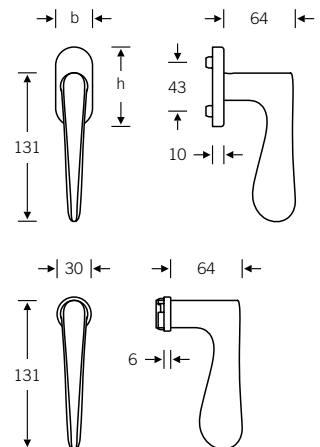

Lever handles for narrow-stile doors

09 1144 (in-line)
06 1144 (cranked)

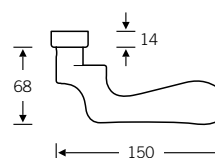
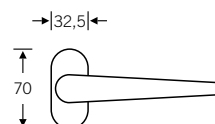
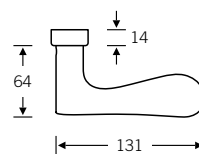
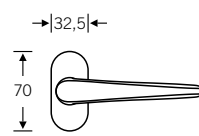

Doorknob for narrow-stile doors

07 0846 (cranked)

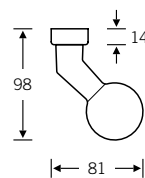
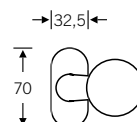

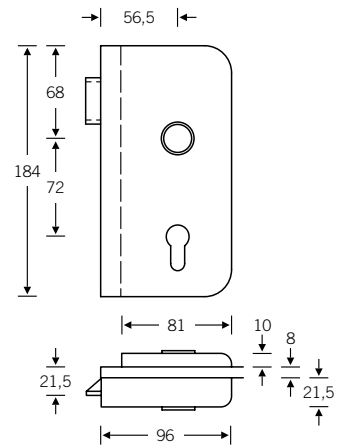

Lever/knob sets

Doorknob for flush doors

Knob backplates

Aluminium X = 77 mm
Stainless steel X = 73 mm

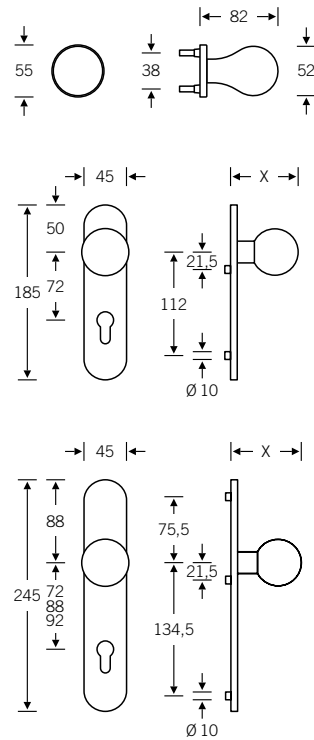

Product codes for the lever/knob sets can be found on the following pages; for individual components, see page 328 ff.

Lever/lever sets

Broad backplate sets available upon request; for flush-fitted roses, see page 536 f.

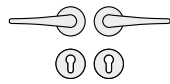

- 12 1144 013 (N)
- 72 1144 613 (R)
- 76 1144 613 (R)

- 12 1144 047 (prv)
- 72 1144 614 (L)
- 76 1144 614 (L)

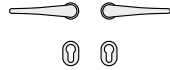

- 15 1144 013 (N)

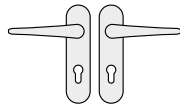

- 12 1144 007 (N)

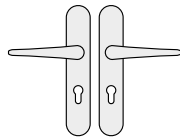

- 12 1144 027 (N)

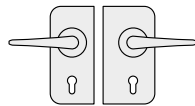

- 13 4223 041 (R) with 10 1144 00500 (N)
- 13 4223 042 (R) with 12 1144 013 (N)
- 13 4223 042 (R) with 72 1144 613 (R)

- 13 4223 051 (L) with 10 1144 00500 (N)
- 13 4223 052 (L) with 12 1144 013 (N)
- 13 4223 052 (L) with 72 1144 614 (L)

Sets for narrow-stile doors

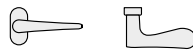

- 09 1144 111
- 09 1144 112 (refit to ILS possible)

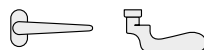

- 06 1144 011
- 06 1144 012
- 06 1144 023 (ILS)



- 07 0846 228 (fixed; aluminium and stainless steel)
- 07 0846 228 (fixed; stainless steel)
- 07 0846 428 (fixed; aluminium)





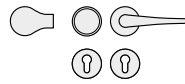

- 17 1757

Lever/knob sets

Broad backplate sets available upon request;
for flush-fitted roses, see page 536 f.



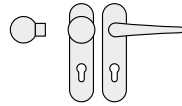

 12 1144 015 (N)
 72 1144 615 (R)
 76 1144 615 (R)

 72 1144 616 (L)
 76 1144 616 (L)

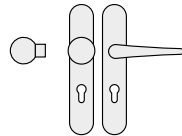

 12 1144 009 (N)





 12 1144 029 (N)

WC sets

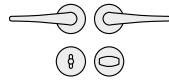
Broad backplate sets available upon request;
for flush-fitted roses, see page 536 f.



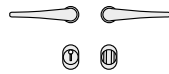

 12 1144 019 (N)
 72 1144 619 (R)

 72 1144 620 (L)

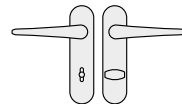

 15 1144 019 (N)



 12 1144 011 (N)

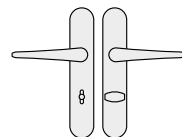



 12 1144 031 (N)



Window handles



34 1144 09030 (rose 27 × 62 × 10)
 34 1144 09039 (rose 32.5 × 70 × 10)
 34 1144 09034 (rose 25.5 × 60.5 flush-fitted)
 34 1144 170 (lock adaptor RC 1–6)
 34 1144 076 (lock adaptor with push-button RC 1–6)
 34 1144 711 (plug-in handle for timber/metal profiles,
 Ø 30)
 34 1144 751 (plug-in handle for PVC profiles, Ø 30)
 34 1144 714 (plug-in handle, lock adaptor RC 1–6)
 34 1144 717 (plug-in handle with push-button RC 1–6)

N = non-handed
 prv = lever handle with privacy function
 R = DIN RH, opening inwards
 L = DIN LH, opening inwards
 ILS = inactive-leaf set

 Female handles
 Plug-in handle for doors
 FSB ASL®

 FSB AGL®
 FS heavy-duty fitting
 EN 179 heavy-duty fitting

For bearings, see page 52 ff.

In the early 1990s, FSB felt the time had come to give the plain round styling of the stable-door handle a makeover. The neck was conically expanded and a hemispherical tip added to the bent end – two subtle but distinctive changes that have given the revamped FSB 1146 model a character all of its own.

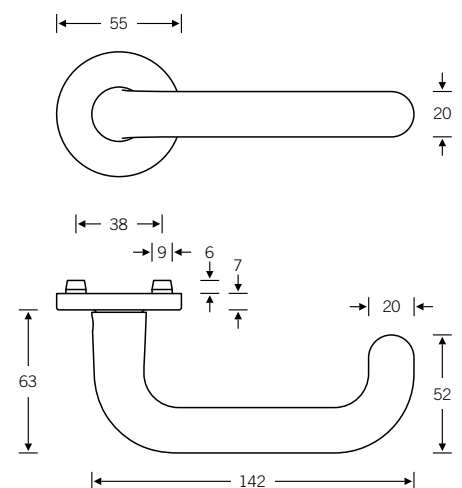

EN 179 model:
Lever handle with return-to-door

Other variants:
– square roses
– oval/angular backplates

Lever handle with privacy function

12 1146

Push-button lock, see page 526 ff.

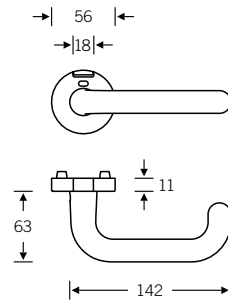

Plug-in handle for doors

15 1146

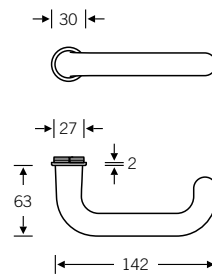

Window handle

Plug-in handle for windows

34 1146

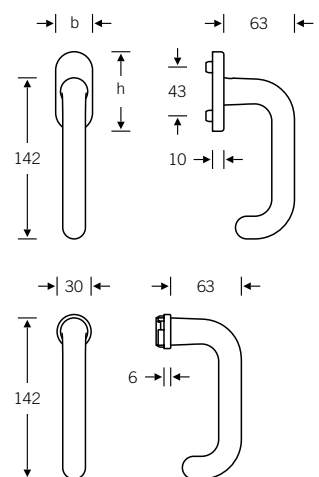

Lifting/sliding door handle

34 1146 011

For more variants, see page 447
For parallel slide/tilt fitting, see page 440

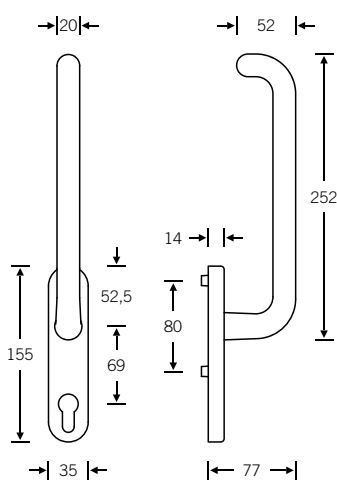

Lever handles
for narrow-stile doors

09 1146 (in-line, EN 179)
06 1146 (cranked, EN 179)

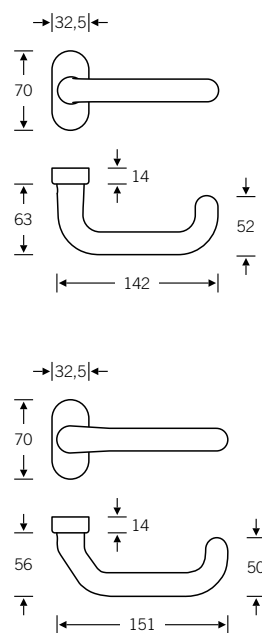

Doorknob
for narrow-stile doors

07 0846 (cranked)

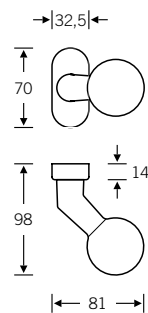

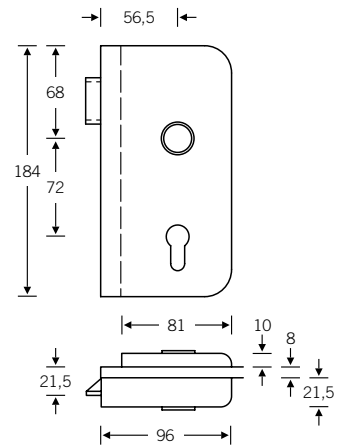

Lever/knob sets

Doorknob for flush doors

Knob backplates

Aluminium X = 77 mm
Stainless steel X = 73 mm

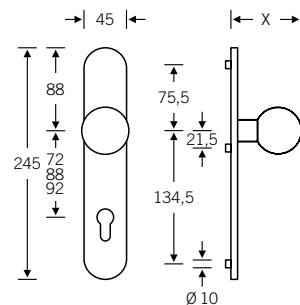
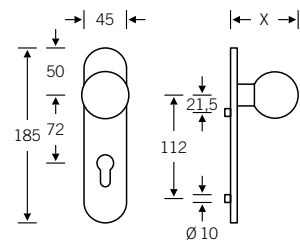
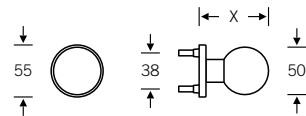





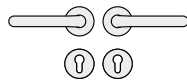

Product codes for the lever/knob sets can be found on the following pages; for individual components, see page 328 ff.

Lever/lever sets

Broad backplate sets available upon request; for flush-fitted roses, see page 536 f.





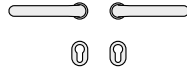

 12 1146 013 (N)
 72 1146 613 (R)
 79 1146 613 (R)

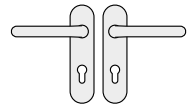

 12 1146 047 (prv)
 72 1146 614 (L)
 79 1146 614 (L)







 15 1146 013 (N)



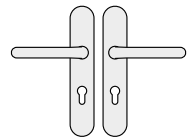

 12 1146 007 (N)
 72 1146 607 (R)
 79 1146 607 (R)



 72 1146 608 (L)
 79 1146 608 (L)



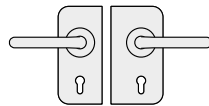

 12 1146 027 (N)
 72 1146 627 (R)
 79 1146 627 (R)

 72 1146 628 (L)
 79 1146 628 (L)





 13 4223 041 (R) with
 10 1146 00500 (N)
 13 4223 042 (R) with
 12 1146 013 (N)
 13 4223 042 (R) with
 72 1146 613 (R)



 13 4223 051 (L) with
 10 1146 00500 (N)
 13 4223 052 (L) with
 12 1146 013 (N)
 13 4223 052 (L) with
 72 1146 614 (L)

Sets for narrow-stile doors





 09 1146 111
 09 1146 112 (refit to ILS possible)



 06 1146 011
 06 1146 012

 06 1146 023 (ILS)



 07 0846 228 (fixed; aluminium and stainless steel)
 07 0846 228 (fixed; stainless steel)
 07 0846 428 (fixed; aluminium)



17 1757

Lever/knob sets

Broad backplate sets available upon request;
for flush-fitted roses, see page 536 f.

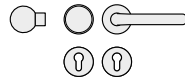

- 12 1146 015 (N)
- 72 1146 615 (R)
- 79 1146 615 (R)
- 79 1146 619 (ILS)

- 72 1146 616 (L)
- 79 1146 616 (L)

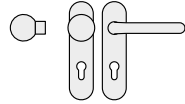

- 12 1146 009 (N)
- 72 1146 609 (R)
- 79 1146 609 (R)
- 79 1146 611 (ILS)

- 72 1146 610 (L)
- 79 1146 610 (L)

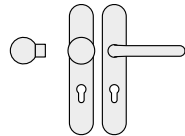

- 12 1146 029 (N)
- 72 1146 629 (R)
- 79 1146 629 (R)
- 79 1146 631 (ILS)

- 72 1146 630 (L)
- 79 1146 630 (L)

WC sets

Broad backplate sets available upon request;
for flush-fitted roses, see page 536 f.

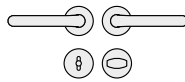

- 12 1146 019 (N)
- 72 1146 619 (R)

- 72 1146 620 (L)

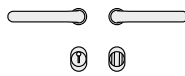

- 15 1146 019 (N)

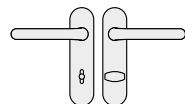

- 12 1146 011 (N)
- 72 1146 611 (R)

- 72 1146 612 (L)

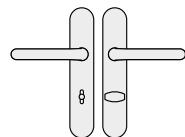

- 12 1146 031 (N)
- 72 1146 631 (R)

- 72 1146 632 (L)

Window handles

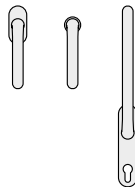

- 34 1146 09030 (rose 27 × 62 × 10)
- 34 1146 09039 (rose 32.5 × 70 × 10)
- 34 1146 09034 (rose 25.5 × 60.5 flush-fitted)
- 34 1146 170 (lock adaptor RC 1–6)
- 34 1146 076 (lock adaptor with push-button RC 1–6)
- 34 1146 711 (plug-in handle for timber/metal profiles, Ø 30)
- 34 1146 751 (plug-in handle for PVC profiles, Ø 30)
- 34 1146 011 (lifting/sliding door handle)

N = non-handed
prv = lever handle with privacy function
R = DIN RH, opening inwards
L = DIN LH, opening inwards
ILS = inactive-leaf set

Female handles
 Plug-in handle for doors
 FSB ASL®

FSB AGL®
 FS heavy-duty fitting
 EN 179 heavy-duty fitting

For bearings, see page 52 ff.

The FSB logo echoes a lever handle designed by Austrian philosopher Ludwig Wittgenstein in mid-1920s Vienna. This is the original upon which all similar door handle shapes are based. By adding a conical neck and spherical tip we aimed to set ourselves apart from the many other variants of this lever handle on the market.

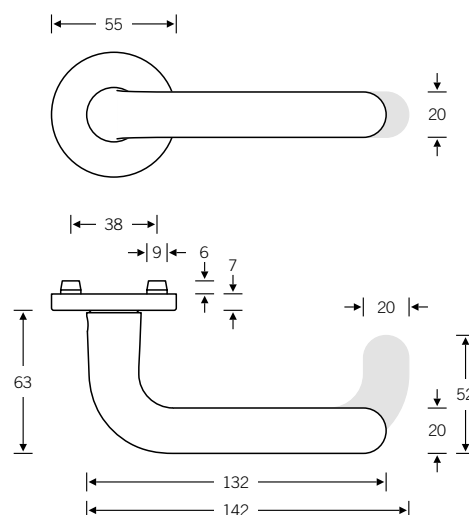

 EN 179 model: FSB 1146
 Lever handle with return-to-door

Other variants:
 – square roses
 – oval/angular backplates

Lever handle with privacy function

12 1147

Push-button lock, see page 526 ff.

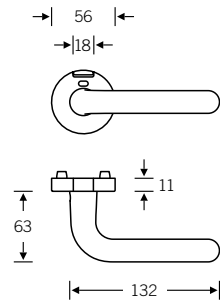

Plug-in handle for doors

15 1147

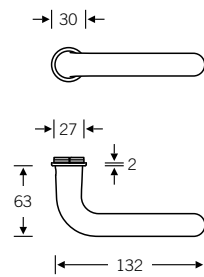

Window handle

Plug-in handle for windows

34 1147

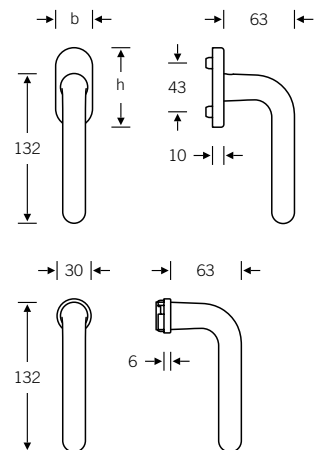

Lifting/sliding door handle

34 1146 011

For more variants, see page 447

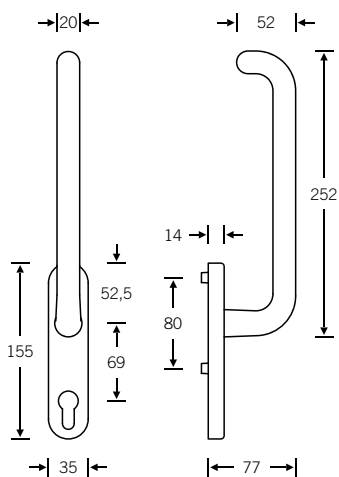

Lever handles
for narrow-stile doors



09 1147 (in-line)

Option with return-to-door:
09 1146 (in-line, EN 179)
06 1146 (cranked, EN 179)
See page 208

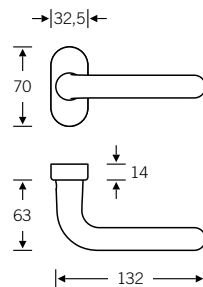

Doorknob
for narrow-stile doors



07 0846 (cranked)

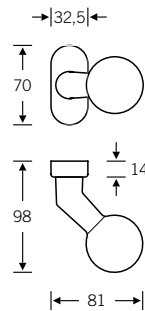

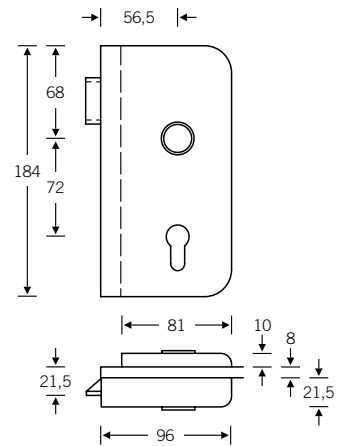

Lever/knob sets

Doorknob for flush doors

Knob backplates

Aluminium X = 77 mm
Stainless steel X = 73 mm

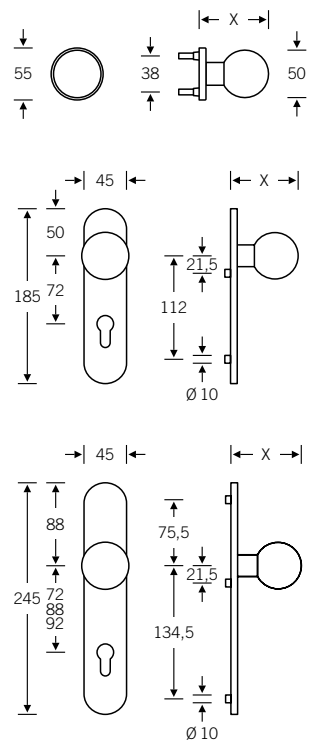

Product codes for the lever/knob sets can be found on the following pages; for individual components, see page 328 ff.

Lever/lever sets

Broad backplate sets available upon request; for flush-fitted roses, see page 536 f.

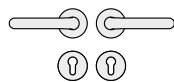

- 12 1147 013 (N)
- 72 1147 613 (R)
- 76 1147 613 (R)
- 79 1146 613 (R)

- 12 1147 047 (prv)
- 72 1147 614 (L)
- 76 1147 614 (L)
- 79 1146 614 (L)

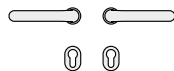

- 15 1147 013 (N)

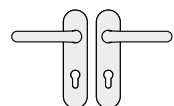

- 12 1147 007 (N)
- 72 1147 607 (R)
- 76 1147 607 (R)
- 79 1146 607 (R)

- 72 1147 608 (L)
- 76 1147 608 (L)
- 79 1146 608 (L)

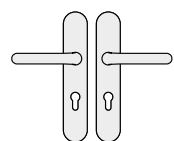

- 12 1147 027 (N)
- 72 1147 627 (R)
- 76 1147 627 (R)
- 79 1146 627 (R)

- 72 1147 628 (L)
- 76 1147 628 (L)
- 79 1146 628 (L)

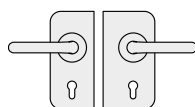

- 13 4223 041 (R) with 10 1147 00500 (N)
- 13 4223 042 (R) with 12 1147 013 (N)
- 13 4223 042 (R) with 72 1147 613 (R)

- 13 4223 051 (L) with 10 1147 00500 (N)
- 13 4223 052 (L) with 12 1147 013 (N)
- 13 4223 052 (L) with 72 1147 614 (L)

Sets for narrow-stile doors



- 09 1147 111
- 09 1147 112 (refit to ILS possible)
- 09 1146 111
- 09 1146 112 (refit to ILS possible)



- 06 1146 011
- 06 1146 012
- 06 1146 023 (ILS)



- 07 0846 228 (fixed; aluminium and stainless steel)
- 07 0846 228 (fixed; stainless steel)
- 07 0846 428 (fixed; aluminium)



- 17 1757

Lever/knob sets

Broad backplate sets available upon request;
for flush-fitted roses, see page 536 f.

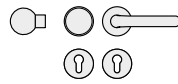

- 12 1147 015 (N)
- 72 1147 615 (R)
- 76 1147 615 (R)
- 79 1146 615 (R)
- 79 1146 619 (ILS)
- 72 1147 616 (L)
- 76 1147 616 (L)
- 79 1146 616 (L)

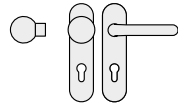

- 12 1147 009 (N)
- 72 1147 609 (R)
- 76 1147 609 (R)
- 79 1146 609 (R)
- 79 1146 611 (ILS)
- 72 1147 610 (L)
- 76 1147 610 (L)
- 79 1146 610 (L)

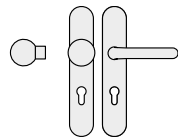

- 12 1147 029 (N)
- 72 1147 629 (R)
- 76 1147 629 (R)
- 79 1146 629 (R)
- 79 1146 631 (ILS)
- 72 1147 630 (L)
- 76 1147 630 (L)
- 79 1146 630 (L)

WC sets

Broad backplate sets available upon request;
for flush-fitted roses, see page 536 f.

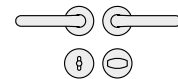

- 12 1147 019 (N)
- 72 1147 619 (R)
- 72 1147 620 (L)

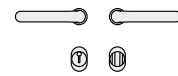

- 15 1147 019 (N)

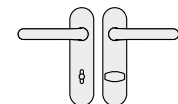

- 12 1147 011 (N)
- 72 1147 611 (R)
- 72 1147 612 (L)

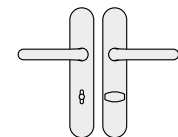

- 12 1147 031 (N)
- 72 1147 631 (R)
- 72 1147 632 (L)

Window handles

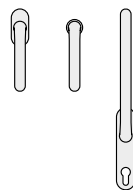

- 34 1147 09030 (rose 27 × 62 × 10)
- 34 1147 09039 (rose 32.5 × 70 × 10)
- 34 1147 09034 (rose 25.5 × 60.5 flush-fitted)
- 34 1147 170 (lock adaptor RC 1–6)
- 34 1147 076 (lock adaptor with push-button RC 1–6)
- 34 1147 711 (plug-in handle for timber/metal profiles, Ø 30)
- 34 1147 751 (plug-in handle for PVC profiles, Ø 30)
- 34 1146 011 (lifting/sliding door handle)

N = non-handed
 prv = lever handle with privacy function
 R = DIN RH, opening inwards
 L = DIN LH, opening inwards
 ILS = inactive-leaf set

Female handles
 Plug-in handle for doors
 FSB ASL®

FSB AGL®
 FS heavy-duty fitting
 EN 179 heavy-duty fitting

For bearings, see page 52 ff.

The process of creating the FSB 1159 began for Laurids and Manfred Ortner with a comparative analysis of lever handle models old and new. In the end they authored a moulded-to-the-hand design, the transitions and flowing surfaces of which impart a sense of holding something trusted and familiar in the hand.

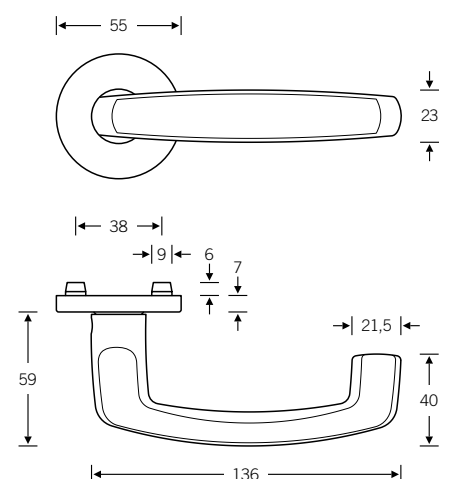

Design: Laurids and Manfred Ortner

 EN 179 model:
 Lever handle with return-to-door

Other variants:
 – square roses
 – oval/angular backplates

Lever handle with privacy function

12 1159

Push-button lock, see page 526 ff.

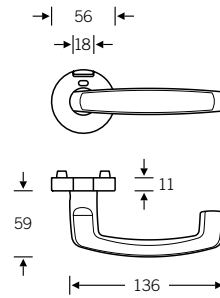

Plug-in handle for doors

15 1159

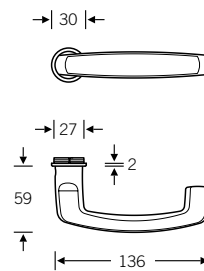

Window handle

Plug-in handle for windows

34 1159

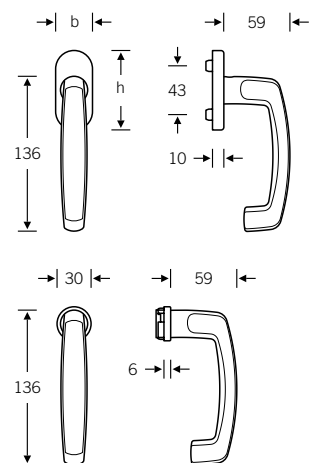

Custom-coordinated lifting/sliding door handle available upon request, see page 10

Lever handles for narrow-stile doors

09 1159 (in-line, EN 179)
06 1159 (cranked, EN 179)

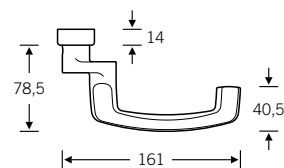
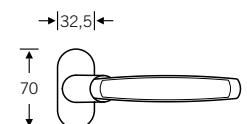
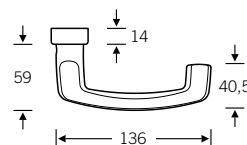
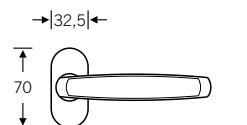

Doorknob for narrow-stile doors

07 0809 (cranked)

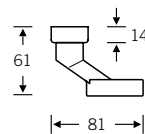
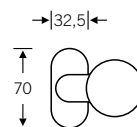

Glass door fitting

13 4223 with 10 1159

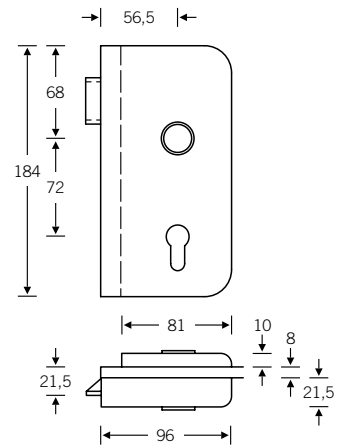

4

Lever/knob sets

Doorknob for flush doors

Knob backplates

Aluminium $\varnothing = 50$
Stainless steel $\varnothing = 55$

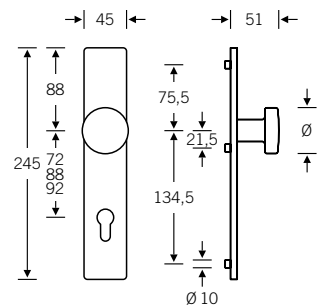
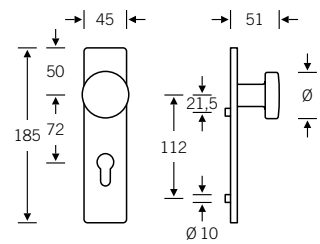
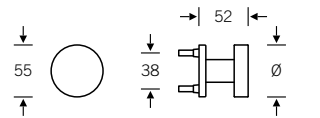





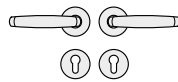

Product codes for the lever/knob sets can be found on the following pages; for individual components, see page 328 ff.

Lever/lever sets

Broad backplate sets available upon request;
for flush-fitted roses, see page 386 f.





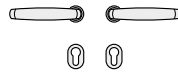

 12 1159 013 (N)
 72 1159 613 (R)
 79 1159 613 (R)

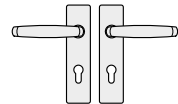

 12 1159 047 (prv)
 72 1159 614 (L)
 79 1159 614 (L)







 15 1159 013 (N)



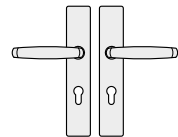

 12 1159 001 (N)
 72 1159 601 (R)
 79 1159 601 (R)



 72 1159 602 (L)
 79 1159 602 (L)



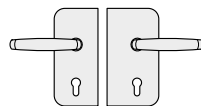

 12 1159 021 (N)
 72 1159 621 (R)
 79 1159 621 (R)

 72 1159 622 (L)
 79 1159 622 (L)





 13 4223 041 (R) with
10 1159 00500 (N)
 13 4223 042 (R) with
12 1159 013 (N)
 13 4223 042 (R) with
72 1159 613 (R)

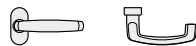

 13 4223 051 (L) with
10 1159 00500 (N)
 13 4223 052 (L) with
12 1159 013 (N)
 13 4223 052 (L) with
72 1159 614 (L)

Sets for narrow-stile doors



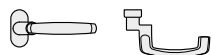

 09 1159 111
 09 1159 112* (refit to ILS possible)



 06 1159 011
 06 1159 012*

 06 1159 023 (ILS)*



 07 0809 228 (fixed; aluminium and stainless steel)
 07 0809 228 (fixed; stainless steel)
 07 0809 428 (fixed; aluminium)



17 1757

Fire safety fittings
only in stainless steel

* In stainless steel only, pursuant to DIN 18273;
for ÖNORM compliance also in aluminium

Lever/knob sets

Broad backplate sets available upon request

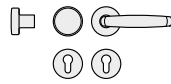

- 12 1159 017 (N)
- 72 1159 617 (R)
- 79 1159 617 (R)
- 79 1159 619 (ILS)
- 72 1159 618 (L)
- 79 1159 618 (L)

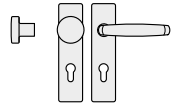

- 12 1159 003 (N)
- 72 1159 603 (R)
- 79 1159 603 (R)
- 79 1159 605 (ILS)
- 72 1159 604 (L)
- 79 1159 604 (L)

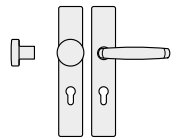

- 12 1159 023 (N)
- 72 1159 623 (R)
- 79 1159 623 (R)
- 79 1159 625 (ILS)
- 72 1159 624 (L)
- 79 1159 624 (L)

WC sets

Broad backplate sets available upon request;
for flush-fitted roses, see page 386 f.

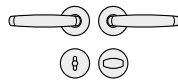

- 12 1159 019 (N)
- 72 1159 619 (R)
- 72 1159 620 (L)

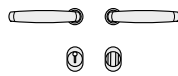

- 15 1159 019 (N)

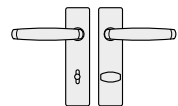

- 12 1159 005 (N)
- 72 1159 605 (R)
- 72 1159 606 (L)

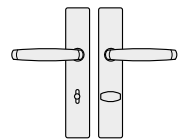

- 12 1159 025 (N)
- 72 1159 625 (R)
- 72 1159 626 (L)

Window handles

Custom-coordinated lifting/sliding door
handle available upon request, see page 10



- 34 1159 09030 (rose 27 × 62 × 10)
- 34 1159 09039 (rose 32.5 × 70 × 10)
- 34 1159 09034 (rose 25.5 × 60.5 flush-fitted)
- 34 1159 170 (lock adaptor RC 1–6)
- 34 1159 076 (lock adaptor with push-button RC 1–6)
- 34 1159 711 (plug-in handle for timber/metal profiles, Ø 30)
- 34 1159 751 (plug-in handle for PVC profiles, Ø 30)

N = non-handed
prv = lever handle with privacy function
R = DIN RH, opening inwards
L = DIN LH, opening inwards
ILS = inactive-leaf set

Female handles
Plug-in handle for doors
FSB ASL®

FSB AGL®
FS heavy-duty fitting
EN 179 heavy-duty fitting

For bearings, see page 52 ff.

Works design FSB 1160 recreates the dynamic 'golden spiral' of geometric growth in the flow of its round cross-section. The handle likewise conforms to golden ratio rules in the way it tapers from neck to end.

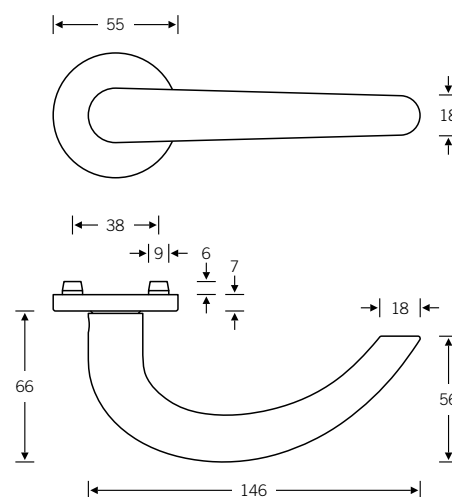

EN 179 model:
Lever handle with return-to-door

Other variants:
– square roses
– oval/angular backplates

Lever handle with privacy function

12 1160

Push-button lock, see page 526 ff.

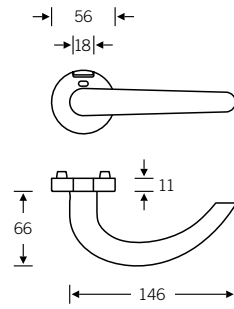

Plug-in handle for doors

15 1160

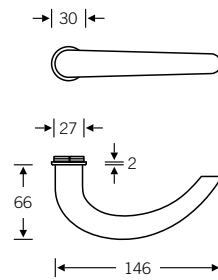

Window handle

Plug-in handle for windows

34 1160

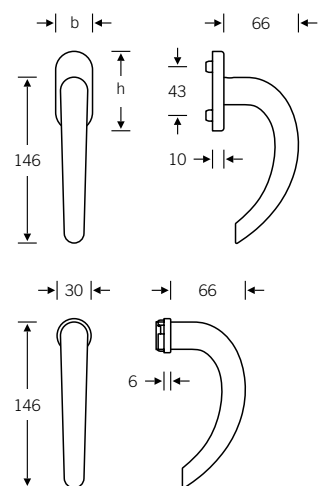

Lever handles for narrow-stile doors

09 1160 (in-line, EN 179)
06 1160 (cranked, EN 179)

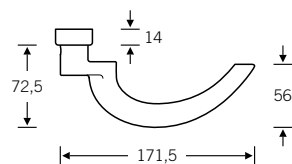
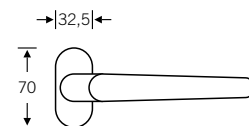
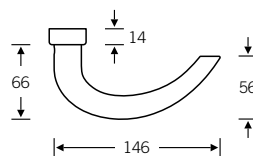
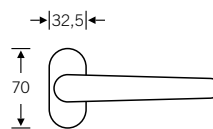

Doorknob for narrow-stile doors

07 0846 (cranked)

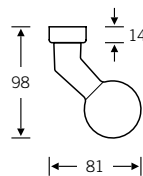
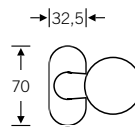

Glass door fitting

13 4223 with 72 1160

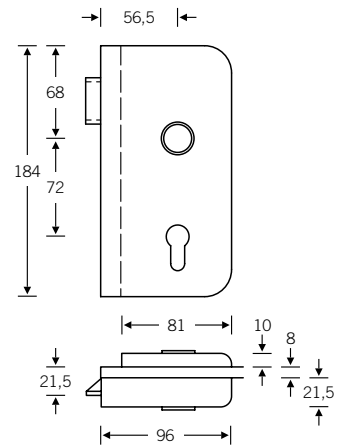

4

Lever/knob sets

Doorknob for flush doors

Knob backplates

Aluminium X = 77 mm
Stainless steel X = 73 mm

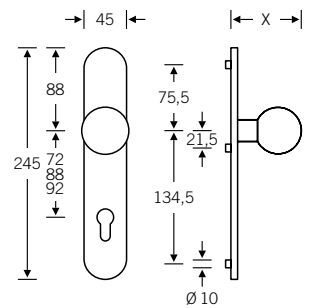
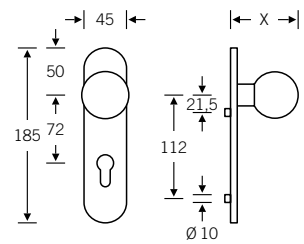
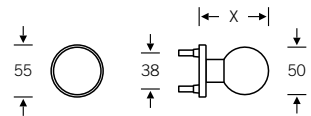





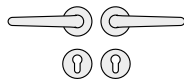

Product codes for the lever/knob sets can be found on the following pages; for individual components, see page 328 ff.

Lever/lever sets

Broad backplate sets available upon request; for flush-fitted roses, see page 386 f.





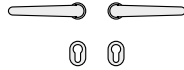

 12 1160 013 (N)
 72 1160 613 (R)
 79 1160 613 (R)

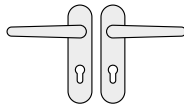

 12 1160 047 (prv)
 72 1160 614 (L)
 79 1160 614 (L)







 15 1160 013 (N)



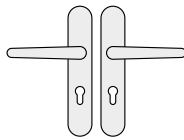

 12 1160 007 (N)
 72 1160 607 (R)
 79 1160 607 (R)



 72 1160 608 (L)
 79 1160 608 (L)



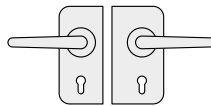

 12 1160 027 (N)
 72 1160 627 (R)
 79 1160 627 (R)

 72 1160 628 (L)
 79 1160 628 (L)





 13 4223 041 (R) with
 10 1160 00500 (N)
 13 4223 042 (R) with
 12 1160 013 (N)
 13 4223 042 (R) with
 72 1160 613 (R)

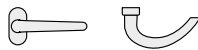

 13 4223 051 (L) with
 10 1160 00500 (N)
 13 4223 052 (L) with
 12 1160 013 (N)
 13 4223 052 (L) with
 12 1160 614 (L)

Sets for narrow-stile doors



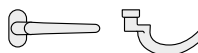

 09 1160 111
 09 1160 112 (refit to ILS possible)



 06 1160 011
 06 1160 012

 06 1160 023 (ILS)



 07 0846 228 (fixed; aluminium and stainless steel)
 07 0846 228 (fixed; stainless steel)
 07 0846 428 (fixed; aluminium)



17 1757

Lever/knob sets

Broad backplate sets available upon request

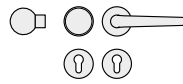

- 12 1160 015 (N)
- 72 1160 615 (R)
- 79 1160 615 (R)
- 79 1160 619 (ILS)
- 72 1160 616 (L)
- 79 1160 616 (L)

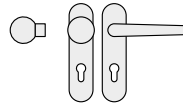

- 12 1160 009 (N)
- 72 1160 609 (R)
- 79 1160 609 (R)
- 79 1160 611 (ILS)
- 72 1160 610 (L)
- 79 1160 610 (L)

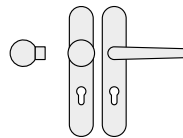

- 12 1160 029 (N)
- 72 1160 629 (R)
- 79 1160 629 (R)
- 79 1160 631 (ILS)
- 72 1160 630 (L)
- 79 1160 630 (L)

WC sets

Broad backplate sets available upon request;
for flush-fitted roses, see page 386 f.

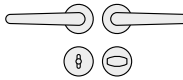

- 12 1160 019 (N)
- 72 1160 619 (R)
- 72 1160 620 (L)

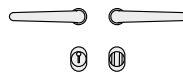

- 15 1160 019 (N)

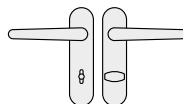

- 12 1160 011 (N)
- 72 1160 611 (R)
- 72 1160 612 (L)

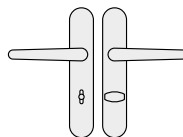

- 12 1160 031 (N)
- 72 1160 631 (R)
- 72 1160 632 (L)

Window handles



- 34 1160 09030 (rose 27 × 62 × 10)
- 34 1160 09039 (rose 32.5 × 70 × 10)
- 34 1160 09034 (rose 25.5 × 60.5 flush-fitted)
- 34 1160 170 (lock adaptor RC 1–6)
- 34 1160 076 (lock adaptor with push-button RC 1–6)
- 34 1160 711 (plug-in handle for timber/metal profiles, Ø 30)
- 34 1160 751 (plug-in handle for PVC profiles, Ø 30)

N = non-handed
 prv = lever handle with privacy function
 R = DIN RH, opening inwards
 L = DIN LH, opening inwards
 ILS = inactive-leaf set

Female handles
 Plug-in handle for doors
 FSB ASL®

FSB AGL®
 FS heavy-duty fitting
 EN 179 heavy-duty fitting

For bearings, see page 52 ff.

Berlin architect Hans Kollhoff devised a handle design for his projects that consciously incorporates design elements from the 1930s. His pared-down door handles, window handles and window fasteners were immediately embraced by the market as authentic interpretations.

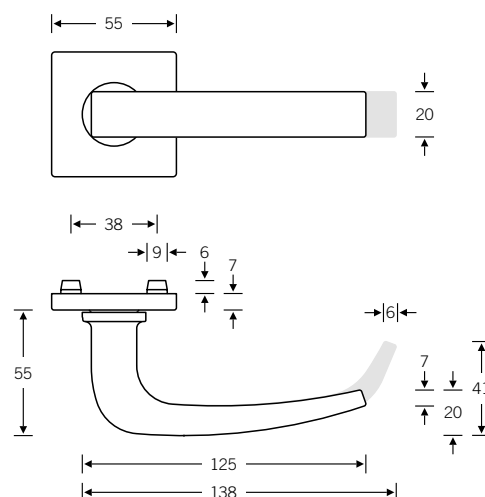

Design: Hans Kollhoff

 EN 179 model: FSB 1164
 Lever handle with return-to-door

Other variants:
 – round roses
 – oval/angular backplates

Lever handle with privacy function

12 1163

Push-button lock, see page 526 ff.

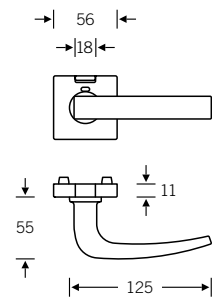

Window handle

34 1163
34 3453

4

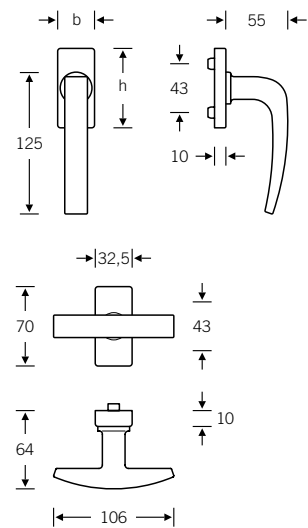

Lifting/sliding door handle

34 1163 021

For more variants, see page 445

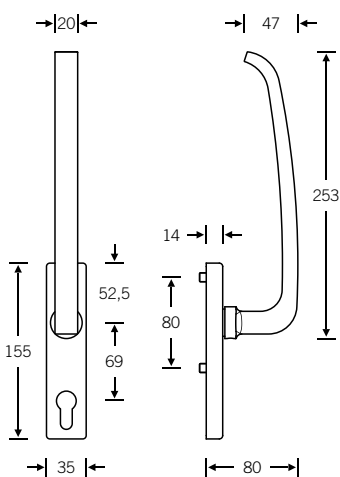

Lever handles
for narrow-stile doors



09 1164 (in-line, EN 179)
06 1164 (cranked, EN 179)

Option without return-to-door:
09 1163 (in-line)
06 1163 (cranked)

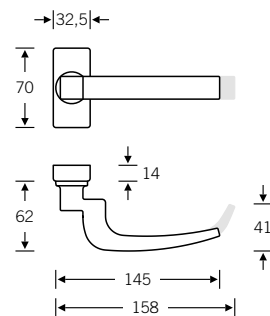
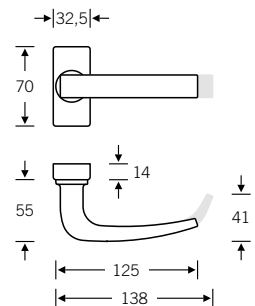

Doorknob
for narrow-stile doors

07 0812 (cranked)

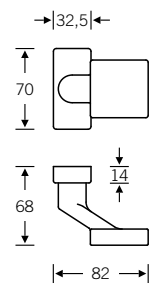

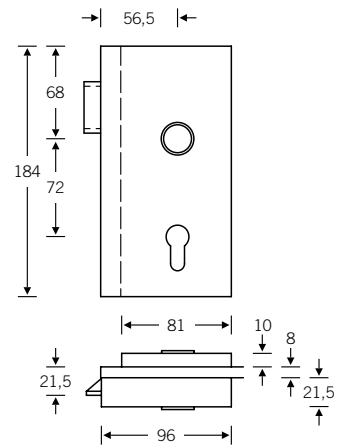

Lever/knob sets

Doorknob for flush doors

Knob backplates

- Aluminium $\varnothing = 50$
- Stainless steel $\varnothing = 55$
- Bronze $\varnothing = 50$

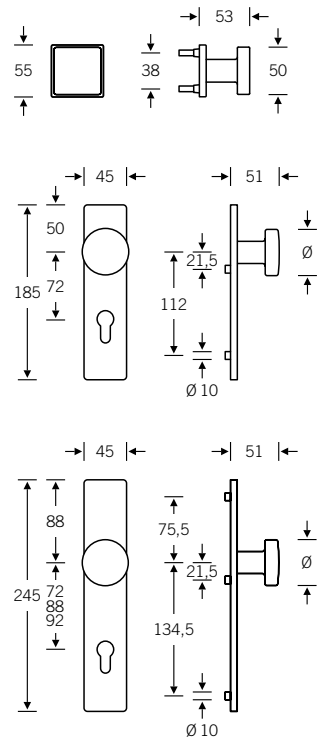

Product codes for the lever/knob sets can be found on the following pages; for individual components, see page 328 ff.

Lever/lever sets

Broad backplate sets available upon request

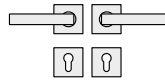

- | | |
|-----------------|-------------------|
| 12 1163 041 (N) | 12 1163 049 (prv) |
| 72 1163 641 (R) | 72 1163 642 (L) |
| 76 1163 639 (R) | 76 1163 640 (L) |
| 79 1164 639 (R) | 79 1164 640 (L) |

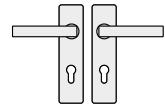

- | | |
|-----------------|-----------------|
| 12 1163 001 (N) | 72 1163 602 (L) |
| 72 1163 601 (R) | 76 1163 602 (L) |
| 76 1163 601 (R) | 79 1164 602 (L) |
| 79 1164 601 (R) | |

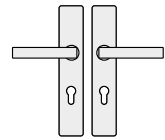

- | | |
|-----------------|-----------------|
| 12 1163 021 (N) | 72 1163 622 (L) |
| 72 1163 621 (R) | 76 1163 622 (L) |
| 76 1163 621 (R) | 79 1164 622 (L) |
| 79 1164 621 (R) | |

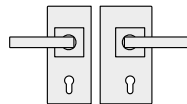

- | | |
|-------------------------------------------|-------------------------------------------|
| 13 4220 041 (R) with 10 1163 00500 (N) | 13 4220 051 (L) with 10 1163 00500 (N) |
| 13 4220 042 (R) with 12 1163 041 (N) | 13 4220 052 (L) with 12 1163 041 (N) |
| 13 4220 042 (R) with 72 1163 641 (R) | 13 4220 052 (L) with 72 1163 642 (L) |
| 13 4220 090* with 76 1163 639 (R) | 13 4220 090* with 76 1163 640 (L) |
| 13 4220 090* with 79 1164 939 (N) | |

Sets for narrow-stile doors

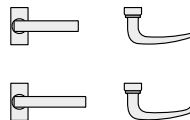

- | |
|-------------------------------------|
| 09 1163 171 |
| 09 1163 172 (refit to ILS possible) |
| 09 1164 172 (refit to ILS possible) |

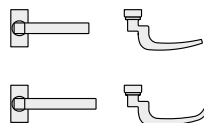

- | | |
|-------------|-------------------|
| 06 1163 071 | 06 1163 073 (ILS) |
| 06 1163 071 | 06 1164 073 (ILS) |
| 06 1164 072 | |



- | |
|------------------------------------------------------------|
| 07 0812 229 (fixed; aluminium, stainless steel and bronze) |
| 07 0812 229 (fixed; stainless steel and bronze) |
| 07 0812 429 (fixed; aluminium) |



17 1778

* Fire safety and EN 179 variants available only in stainless steel; for variants, see page 508

Lever/knob sets

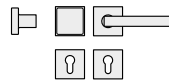

- 12 1163 043 (N)
- 72 1163 643 (R)
- 76 1163 641 (R)
- 79 1164 641 (R)
- 79 1164 643 (ILS)
- 72 1163 644 (L)
- 76 1163 642 (L)
- 79 1164 642 (L)

Broad backplate sets available upon request

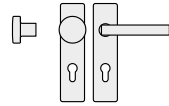

- 12 1163 003 (N)
- 72 1163 603 (R)
- 76 1163 603 (R)
- 79 1164 603 (R)
- 79 1164 605 (ILS)
- 72 1163 604 (L)
- 76 1163 604 (L)
- 79 1164 604 (L)

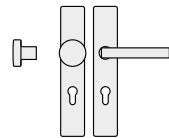

- 12 1163 023 (N)
- 72 1163 623 (R)
- 76 1163 623 (R)
- 79 1164 623 (R)
- 79 1164 625 (ILS)
- 72 1163 624 (L)
- 76 1163 624 (L)
- 79 1164 624 (L)

WC sets

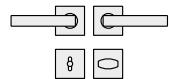

- 12 1163 045 (N)
- 72 1163 645 (R)
- 72 1163 646 (L)

Broad backplate sets available upon request

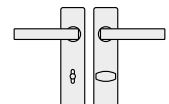

- 12 1163 005 (N)
- 72 1163 605 (R)
- 72 1163 606 (L)

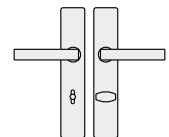

- 12 1163 025 (N)
- 72 1163 625 (R)
- 72 1163 626 (L)

Window handles

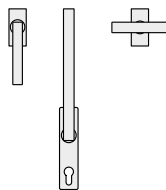

- 34 1163 09040 (rose 32.5 × 70 × 10)
- 34 1163 180 (lock adaptor RC 1–6)
- 34 1163 086 (lock adaptor with push-button RC1–6)
- 34 3453 (tee handle for window)
- 34 1163 021 (lifting/sliding door handle)

N = non-handed
 prv = lever handle with privacy function
 R = DIN RH, opening inwards
 L = DIN LH, opening inwards
 ILS = inactive-leaf set

Female handles
 Plug-in handle for doors
 FSB ASL®

FSB AGL®
 FS heavy-duty fitting
 EN 179 heavy-duty fitting

For bearings, see page 52 ff.

The FSB 1176 derives its shape from a classic design in the FSB range. The neck and tip of this handle were originally made of rolled steel, then later of cast aluminium, while the grip section itself was a chunky affair in black plastic. Here, too, the toolmakers at FSB have now succeeded in fashioning this heritage form out of stainless steel tubing.

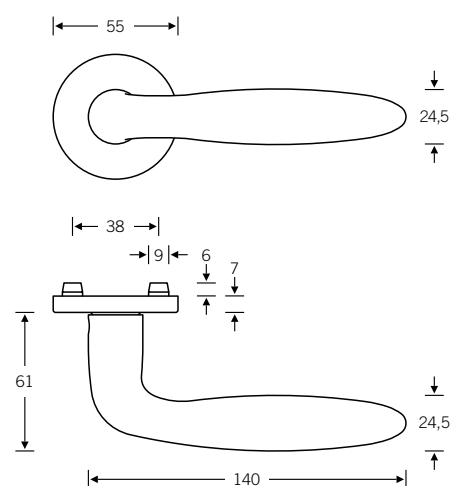

Other variants:
 – square roses
 – oval/angular backplates

Lever handle with privacy function

12 1176

Push-button lock, see page 526 ff.

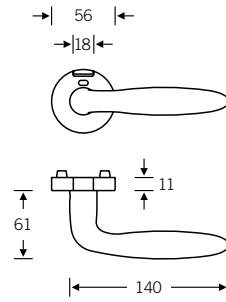

Plug-in handle for doors

15 1176

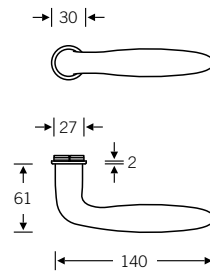

Window handle

Plug-in handle for windows

34 1176

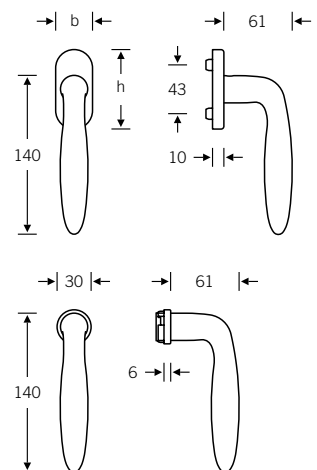

Lever/lever sets

Broad backplate sets available upon request;
for flush-fitted roses, see page 386 f.

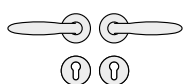

➤ 12 1176 013 (N)

➤ 12 1176 047 (prv)

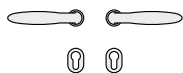

➤ 15 1176 013 (N)

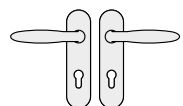

➤ 12 1176 007 (N)

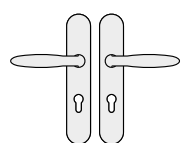

➤ 12 1176 027 (N)

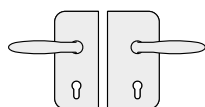

➤ 13 4223 041 (R) with
10 1176 00500 (N)

➤ 13 4223 042 (R) with
12 1176 013 (N)

➤ 13 4223 051 (L) with
10 1176 00500 (N)

➤ 13 4223 052 (L) with
12 1176 013 (N)

Lever/knob sets

Broad backplate sets available upon request
For associated knobs, see page 322



➤ 12 1176 015 (N)

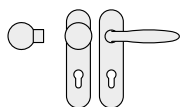

➤ 12 1176 009 (N)

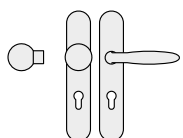

➤ 12 1176 029 (N)

WC sets

Broad backplate sets available upon request;
for flush-fitted roses, see page 386 f.

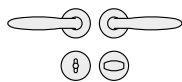

 12 1176 019 (N)

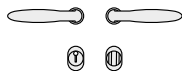

 15 1176 019 (N)

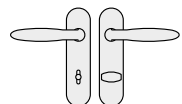

 12 1176 011 (N)

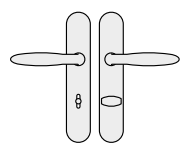



 12 1176 031 (N)



Window handles



- 34 1176 09030 (rose 27 × 62 × 10)
- 34 1176 09039 (rose 32.5 × 70 × 10)
- 34 1176 170 (lock adaptor RC 1–6)
- 34 1176 076 (lock adaptor with push-button RC1–6)
- 34 1176 711 (plug-in handle for timber/metal profiles, Ø 30)
- 34 1176 751 (plug-in handle for PVC profiles, Ø 30)

N = non-handed
 prv = lever handle with privacy function
 R = DIN RH, opening inwards
 L = DIN LH, opening inwards
 ILS = inactive-leaf set

 Female handles
 Plug-in handle for doors
 FSB ASL®

 FSB AGL®
 FS heavy-duty fitting
 EN 179 heavy-duty fitting

For bearings, see page 52 ff.

The 'Wittgenstein solution', in which a standard lever handle is paired with a cranked design on the closing side of the door, is one we are very familiar with. Hadi Teherani, by contrast, delivers the function of the cranked handle – reducing the risk of getting your fingers caught – by simply shifting the handle's centre of rotation to the left.

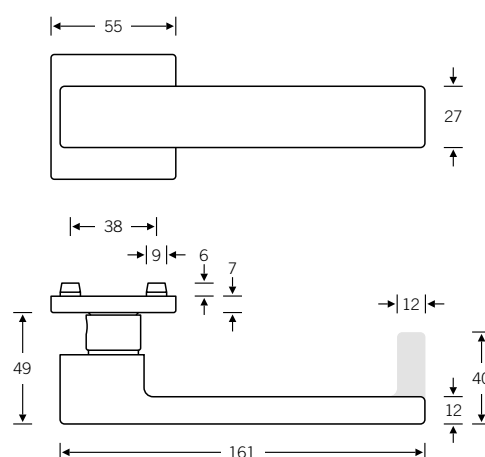

Design: Hadi Teherani

 EN 179 model: FSB 1074
 Lever handle with return-to-door

Other variants:
 – round roses
 – oval/angular backplates

Lever handle with privacy function

12 1183

Push-button lock, see page 526 ff.

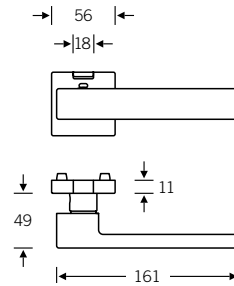

Plug-in handle for doors

15 1183

4

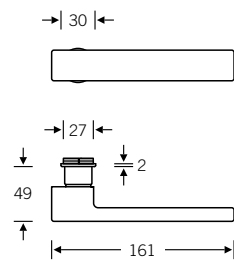

Window handle

Plug-in handle for windows

34 1183

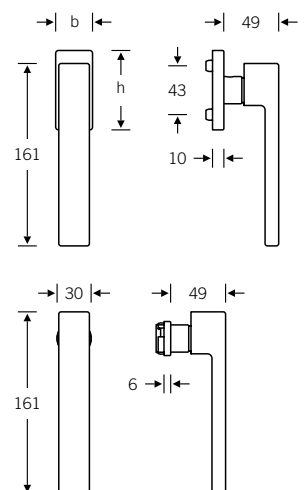

Custom-coordinated lifting/sliding door handle available upon request, see page 10

Lever handles for narrow-stile doors

09 1074 (in-line, EN 179)
06 0644 (cranked, EN 179)

Option without return-to-door:
09 1183 (in-line)

Suitable for backsets of 40 mm upwards

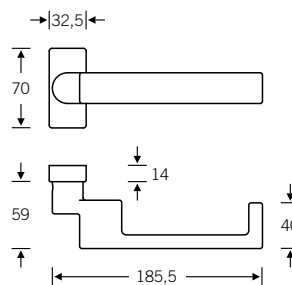
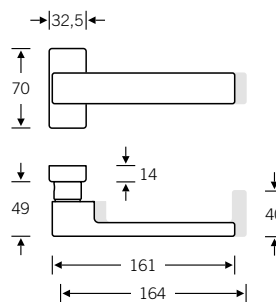

Doorknob for narrow-stile doors

07 0812 (cranked)

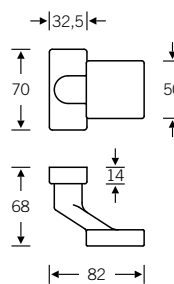

Glass door fitting

13 4220 with 10 1183

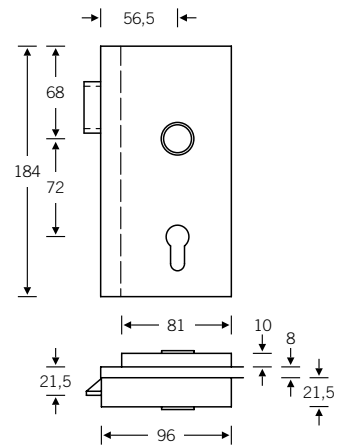

4

Lever/knob sets

Doorknob for flush doors

Knob backplates

- Aluminium $\varnothing = 50$
- Stainless steel $\varnothing = 55$
- Bronze $\varnothing = 50$

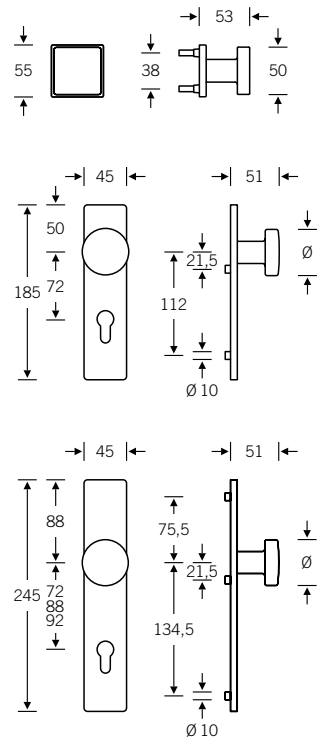

Product codes for the lever/knob sets can be found on the following pages; for individual components, see page 328 ff.

Lever/lever sets

Broad backplate sets available upon request; for flush-fitted roses, see page 536 f.

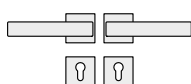

- 🔑 12 1183 041 (N)
- 🔑 72 1183 641 (R)
- 🔑 76 1183 639 (R)
- 🔑 79 1074 639 (R)

- 🔑 12 1183 049 (prv)
- 🔑 72 1183 642 (L)
- 🔑 76 1183 640 (L)
- 🔑 79 1074 640 (L)

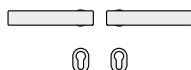

- 🔑 15 1183 013 (N)

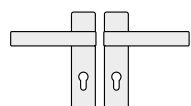

- 🔑 12 1183 001 (N)
- 🔑 72 1183 601 (R)
- 🔑 76 1183 601 (R)
- 🔑 79 1074 601 (R)

- 🔑 72 1183 602 (L)
- 🔑 76 1183 602 (L)
- 🔑 79 1074 602 (L)

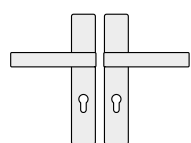

- 🔑 12 1183 021 (N)
- 🔑 72 1183 621 (R)
- 🔑 76 1183 621 (R)
- 🔑 79 1074 621 (R)

- 🔑 72 1183 622 (L)
- 🔑 76 1183 622 (L)
- 🔑 79 1074 622 (L)

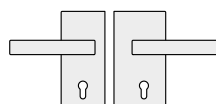

- 🔑 13 4220 041 (R) with 10 1183 00500 (N)
- 🔑 13 4220 042 (R) with 12 1183 041 (N)
- 🔑 13 4220 042 (R) with 72 1183 641 (R)
- 🔑 13 4220 090* with 76 1183 639 (R)
- 🔑 13 4220 090* with 79 1074 939 (N)

- 🔑 13 4220 051 (L) with 10 1183 00500 (N)
- 🔑 13 4220 052 (L) with 12 1183 041 (N)
- 🔑 13 4220 052 (L) with 72 1183 642 (L)
- 🔑 13 4220 090* with 76 1183 640 (L)

Sets for narrow-stile doors



- 🔑 09 1183 171
- 🔑 09 1183 172 (refit to ILS possible)
- 🔑 09 1074 172 (refit to ILS possible)



- 🔑 06 1183 071
- 🔑 06 1074 072

- 🔑 06 1074 073 (ILS)



- 🔑 07 0812 229 (fixed; aluminium and stainless steel)
- 🔑 07 0812 229 (fixed; stainless steel)
- 🔑 07 0812 429 (fixed; aluminium)



- 17 1778

* Fire safety and EN 179 variants available only in stainless steel; for variants, see page 508

Lever/knob sets

Broad backplate sets available upon request; for flush-fitted roses, see page 536 f.

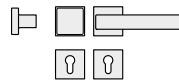

- 12 1183 043 (N)
- 72 1183 643 (R)
- 76 1183 641 (R)
- 79 1074 641 (R)
- 79 1074 643 (ILS)
- 72 1183 644 (L)
- 76 1183 642 (L)
- 79 1074 642 (L)

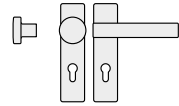

- 12 1183 003 (N)
- 72 1183 603 (R)
- 76 1183 603 (R)
- 79 1074 603 (R)
- 79 1074 605 (ILS)
- 72 1183 604 (L)
- 76 1183 604 (L)
- 79 1074 604 (L)

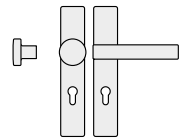

- 12 1183 023 (N)
- 72 1183 623 (R)
- 76 1183 623 (R)
- 79 1074 623 (R)
- 79 1074 625 (ILS)
- 72 1183 624 (L)
- 76 1183 624 (L)
- 79 1074 624 (L)

WC sets

Broad backplate sets available upon request; for flush-fitted roses, see page 536 f.

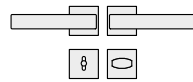

- 12 1183 045 (N)
- 72 1183 645 (R)
- 72 1183 646 (L)

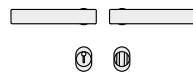

- 15 1183 019 (N)

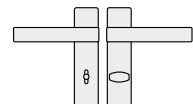

- 12 1183 005 (N)
- 72 1183 605 (R)
- 72 1183 606 (L)

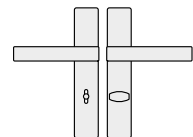

- 12 1183 025 (N)
- 72 1183 625 (R)
- 72 1183 626 (L)

Window handles

Custom-coordinated lifting/sliding door handle available upon request, see page 10

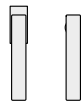

- 34 1183 09032 (rose 27 × 62 × 10)
- 34 1183 09040 (rose 32.5 × 70 × 10)
- 34 1183 09036 (rose 25.5 × 60.5 flush-fitted)
- 34 1183 180 (lock adaptor RC 1–6)
- 34 1183 086 (lock adaptor with push-button RC 1–6)
- 34 1183 711 (plug-in handle for timber/metal profiles, Ø 30)
- 34 1183 751 (plug-in handle for PVC profiles, Ø 30)

N = non-handed
 prv = lever handle with privacy function
 R = DIN RH, opening inwards
 L = DIN LH, opening inwards
 ILS = inactive-leaf set

Female handles
 Plug-in handle for doors
 FSB ASL®

FSB AGL®
 FS heavy-duty fitting
 EN 179 heavy-duty fitting

For bearings, see page 52 ff.

Werner Aisslinger's eminently sculptural handle evokes a sense of motion away from the body and into the surrounding space. The idea rose as he was contemplating the opposing sequences of operations involved when opening and closing a door. Almost as a by-product of this thought process, the shape was lent to an evocative moulded-to-the-hand model that masterfully aligns with the 'Four-Point Guide to Good Grip' devised by Otl Aicher.

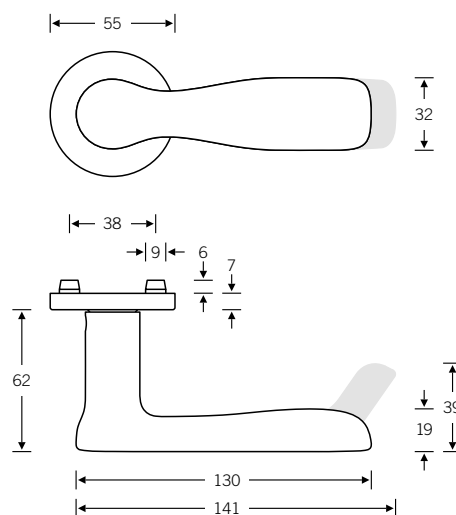

Design: Werner Aisslinger

EN 179 model: FSB 1278
Lever handle with return-to-door

Other variants:
– square roses
– oval/angular backplates

Lever handle with privacy function

12 1226

Push-button lock, see page 526 ff.

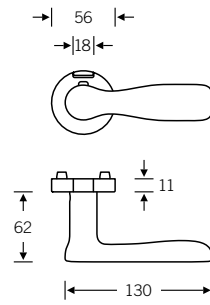

Plug-in handle for doors

15 1226

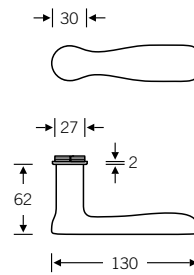

Window handle

Plug-in handle for windows

34 1226

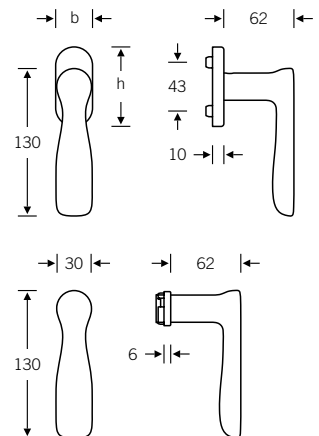

Lever/lever sets

Broad backplate sets available upon request;
for flush-fitted roses, see page 536 f.

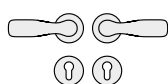

- 12 1226 013 (N)
- 72 1226 613 (R)
- 76 1226 613 (R)
- 79 1278 613 (R)

- 12 1226 047 (prv)
- 72 1226 614 (L)
- 76 1226 614 (L)
- 79 1278 614 (L)

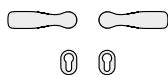

- 15 1226 013 (N)

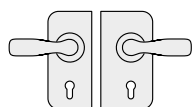

- 13 4220 041 (R) with 10 1226 00500 (N)
- 13 4223 042 (R) with 12 1226 013 (N)
- 13 4223 042 (R) with 72 1226 613 (R)

- 13 4220 051 (L) with 10 1226 00500 (N)
- 13 4223 052 (L) with 12 1226 013 (N)
- 13 4223 052 (L) with 72 1226 614 (L)

Lever/knob sets

Broad backplate sets available upon request;
for flush-fitted roses, see page 536 f.;
for associated knobs, see page 328 f.

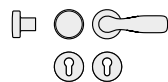

- 12 1226 017 (N)
- 72 1226 617 (R)

- 72 1226 618 (L)

WC sets

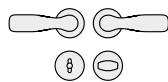

 12 1226 019 (N)
 72 1226 619 (R)

 72 1226 620 (L)

Broad backplate sets available upon request;
for flush-fitted roses, see page 536 f.

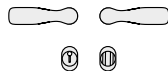

 15 1226 019 (N)



4



Window handles



34 1226 09030 (rose 27 × 62 × 10)
 34 1226 09039 (rose 32.5 × 70 × 10)
 34 1226 170 (lock adaptor RC 1–6)
 34 1226 076 (lock adaptor with push-button RC 1–6)
 34 1226 711 (plug-in handle for timber/metal profiles,
 Ø 30)
 34 1226 751 (plug-in handle for PVC profiles, Ø 30)

N = non-handed
 prv = lever handle with privacy function
 R = DIN RH, opening inwards
 L = DIN LH, opening inwards
 ILS = inactive-leaf set

 Female handles
 Plug-in handle for doors
 FSB ASL®

 FSB AGL®
 FS heavy-duty fitting
 EN 179 heavy-duty fitting

For bearings, see page 52 ff.

The provisions of the German Social Accident Insurance (DGUV) specifying minimum radii as an accident prevention measure generally preclude the use of strikingly angular handle designs. Drawing on the primary shapes of the square and circle, the FSB 1232 marries compliance with DGUV provisions to compelling ergonomics and appealing visuals.

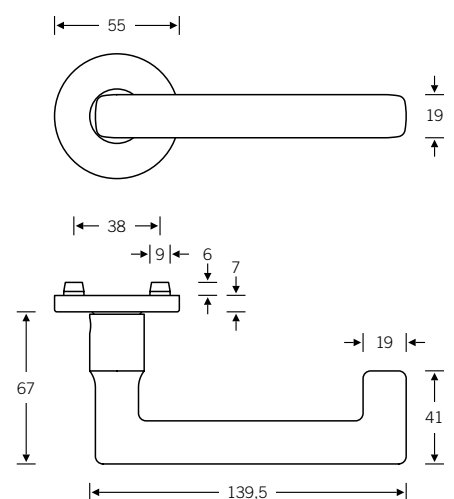

 EN 179 model:
Lever handle with return-to-door

Other variants:
– square roses
– oval/angular backplates

Lever handle with privacy function

12 1232

Push-button lock, see page 526 ff.

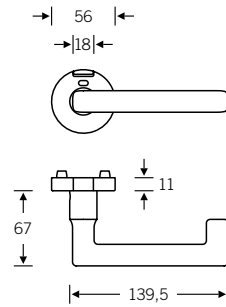

Plug-in handle for doors

15 1232

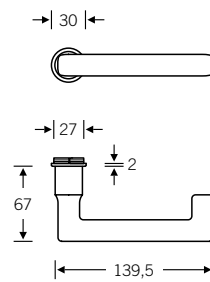

Window handle

Plug-in handle for windows

34 1232

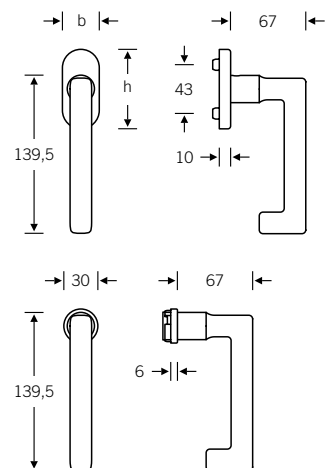

Custom-coordinated lifting/sliding door handle available upon request, see page 10

Lever handles for narrow-stile doors

09 1232 (in-line, EN 179)
06 1232 (cranked, EN 179)

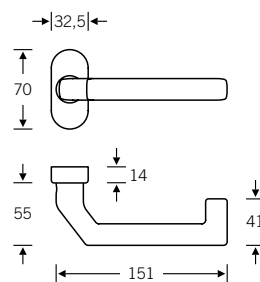
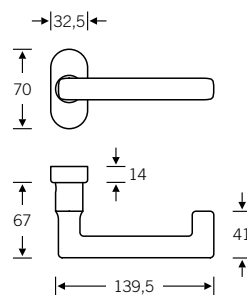

Doorknob for narrow-stile doors

07 0809 (cranked)

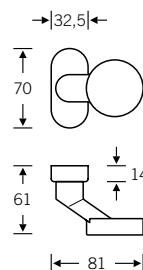

Glass door fitting

13 4220 with 72 1232

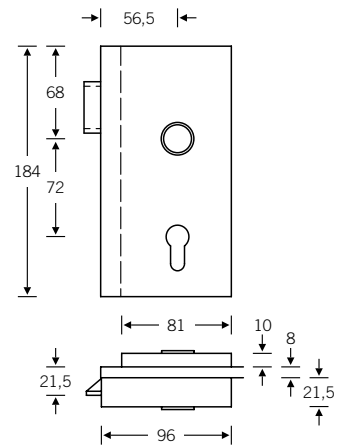

4

Lever/knob sets

Doorknob for flush doors

Knob backplates

Aluminium $\varnothing = 50$

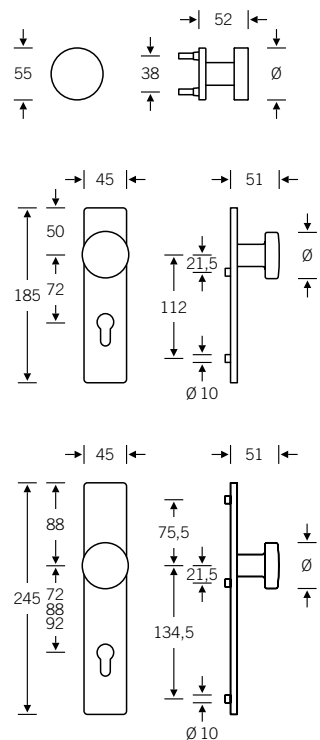

Product codes for the lever/knob sets can be found on the following pages; for individual components, see page 328 ff.

Lever/lever sets

Broad backplate sets available upon request; for flush-fitted roses, see page 536 f.

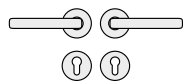

- 12 1232 013 (N)
- 72 1232 613 (R)
- 79 1232 613 (R)

- 12 1232 047 (prv)
- 72 1232 614 (L)
- 79 1232 614 (L)

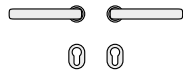

- 15 1232 013 (N)

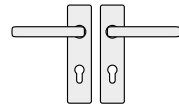

- 12 1232 001 (N)
- 72 1232 601 (R)
- 79 1232 601 (R)

- 72 1232 602 (L)
- 79 1232 602 (L)

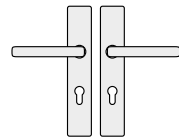

- 12 1232 021 (N)
- 72 1232 621 (R)
- 79 1232 621 (R)

- 72 1232 622 (L)
- 79 1232 622 (L)

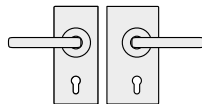

- 13 4220 041 (R) with 10 1232 00500 (N)
- 13 4220 042 (R) with 12 1232 013 (N)
- 13 4220 042 (R) with 72 1232 613 (R)

- 13 4220 051 (L) with 10 1232 00500 (N)
- 13 4220 052 (L) with 12 1232 013 (N)
- 13 4220 052 (L) with 72 1232 614 (L)

Sets for narrow-stile doors

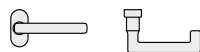

- 09 1232 111
- 09 1232 112 (refit to ILS possible)

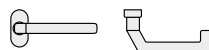

- 06 1232 011
- 06 1232 012

- 06 1232 023 (ILS)



- 07 0809 228 (fixed)
- 07 0809 428 (fixed)



- 17 1757

Lever/knob sets

Broad backplate sets available upon request; for flush-fitted roses, see page 536 f.

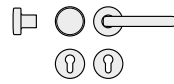

- 12 1232 017 (N)
- 72 1232 617 (R)
- 79 1232 617 (R)
- 79 1232 619 (ILS)
- 72 1232 618 (L)
- 79 1232 618 (L)

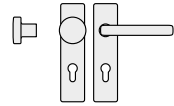

- 12 1232 003 (N)
- 72 1232 603 (R)
- 79 1232 603 (R)
- 79 1232 605 (ILS)
- 72 1232 604 (L)
- 79 1232 604 (L)

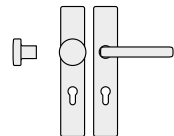

- 12 1232 023 (N)
- 72 1232 623 (R)
- 79 1232 623 (R)
- 79 1232 625 (ILS)
- 72 1232 624 (L)
- 79 1232 624 (L)

WC sets

Broad backplate sets available upon request; for flush-fitted roses, see page 536 f.

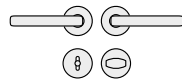

- 12 1232 019 (N)
- 72 1232 619 (R)
- 72 1232 620 (L)

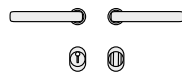

- 15 1232 019 (N)

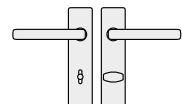

- 12 1232 005 (N)
- 72 1232 605 (R)
- 72 1232 606 (L)

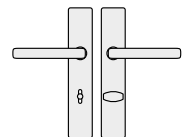

- 12 1232 025 (N)
- 72 1232 625 (R)
- 72 1232 626 (L)

Window handles

Custom-coordinated lifting/sliding door handle available upon request, see page 10



- 34 1232 09030 (rose 27 × 62 × 10)
- 34 1232 09039 (rose 32.5 × 70 × 10)
- 34 1232 09034 (rose 25.5 × 60.5 flush-fitted)
- 34 1232 170 (lock adaptor RC 1–6)
- 34 1232 076 (lock adaptor with push-button RC 1–6)
- 34 1232 711 (plug-in handle for timber/metal profiles, Ø 30)
- 34 1232 751 (plug-in handle for PVC profiles, Ø 30)

N = non-handed
 prv = lever handle with privacy function
 R = DIN RH, opening inwards
 L = DIN LH, opening inwards
 ILS = inactive-leaf set

Female handles
 Plug-in handle for doors
 FSB ASL®

FSB AGL®
 FS heavy-duty fitting
 EN 179 heavy-duty fitting

For bearings, see page 52 ff.

Paris-based architects RDAI designed the FSB 1241 as part of the corporate architecture for flagship stores run by one of the world's best-known fashion brands. Its neck features a square cross-section, half of which transitions into a precisely ellipsoid shape from the point of rotation onwards.

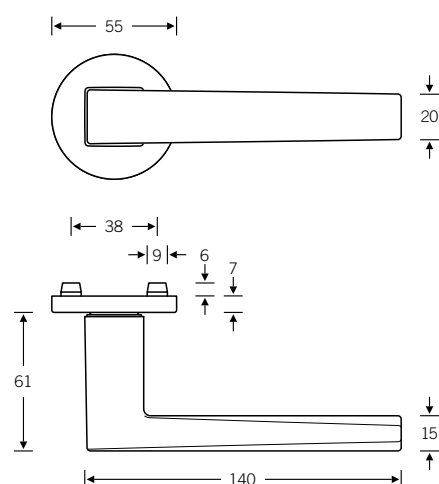

Design: RDAI

Other variants:
– square roses
– oval/angular backplates

Lever handle with privacy function

12 1241

Push-button lock, see page 526 ff.

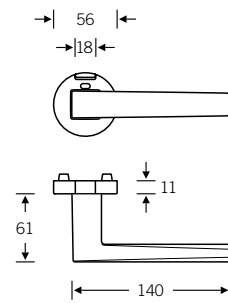

Window handle

34 1241

4

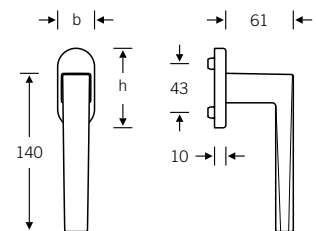

Lever/lever sets

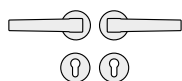

🔑 12 1241 013 (N)

🔑 12 1241 047 (prv)

Broad backplate sets available upon request

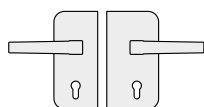

🔑 13 4223 042 (R) with
12 1241 013 (N)

🔑 13 4223 052 (L) with
12 1241 013 (N)

Lever/knob sets

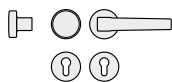

🔑 12 1241 017 (N)

Broad backplate sets available upon request;
for associated knobs, see page 328 f.

WC sets

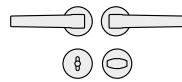

 12 1241 019 (N)

Broad backplate sets available upon request



4



Window handles



34 1241 09030 (rose 27 × 62 × 10)
34 1241 09034 (rose 25.5 × 60.5 flush-fitted)
34 1241 09039 (rose 32.5 × 70 × 10)
34 1241 170 (lock adaptor RC 1–6)
34 1241 076 (lock adaptor with push-button RC 1–6)

N = non-handed
prv = lever handle with privacy function
R = DIN RH, opening inwards
L = DIN LH, opening inwards
ILS = inactive-leaf set

 Female handles
 Plug-in handle for doors
 FSB ASL®

 FSB AGL®
 FS heavy-duty fitting
 EN 179 heavy-duty fitting

For bearings, see page 52 ff.

British architect John Pawson subtly revises an iconic Modernist handle – the ‘Reich Shape’ handle by Hans Poelzig – quietly breathing new life into this familiar form. Fabricated in classic bronze, Pawson’s meticulously proportioned design reworks the oval cross-section to produce a handle that is comfortable in the hand and pleasing to the eye – the latest expression of an idea that has been repeatedly modified over the course of nearly a century.

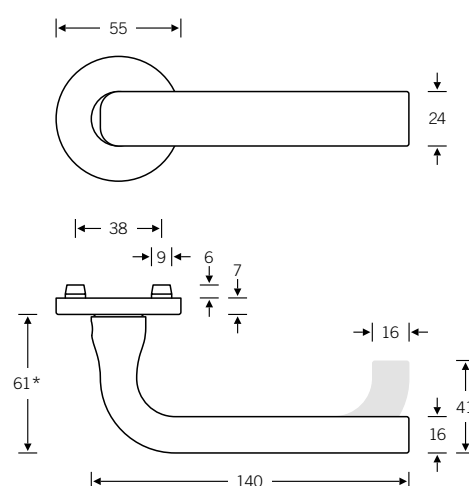

* Aluminium/stainless steel: 66 mm

Design: John Pawson

 EN 179 model: FSB 1243
 Lever handle with return-to-door

Other variants:
 – square roses
 – oval/angular backplates

Lever handle with privacy function

12 1242

Push-button lock, see page 526 ff.

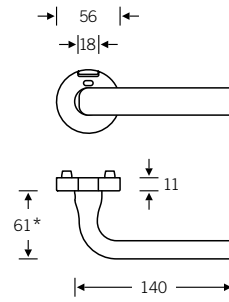

* Aluminium/stainless steel: 66 mm

Plug-in handle for doors

15 1242

4

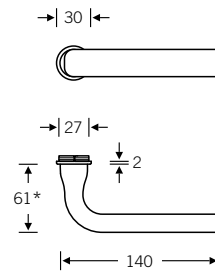

* Aluminium/stainless steel: 66 mm

Window handle

Plug-in handle for windows

34 1242

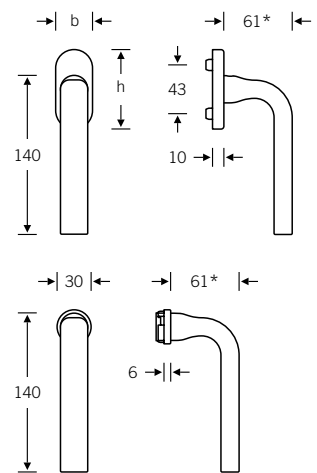

* Aluminium/stainless steel: 66 mm



Lifting/sliding door handle

34 1242 011

For more variants, see page 448

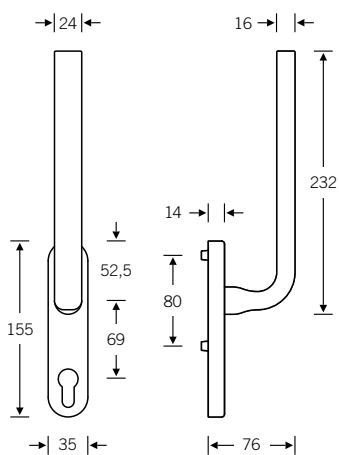

Lever handles
for narrow-stile doors



09 1243 (in-line, EN 179)
06 1243 (cranked, EN 179)

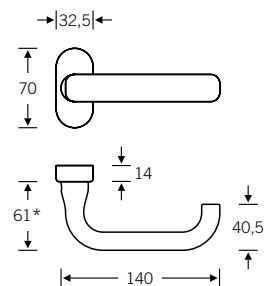

* Aluminium/stainless steel: 66 mm

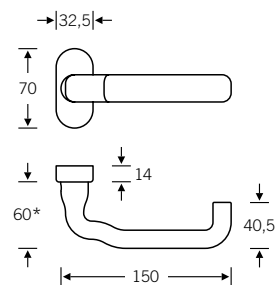

Doorknob
for narrow-stile doors

07 0846 (cranked)

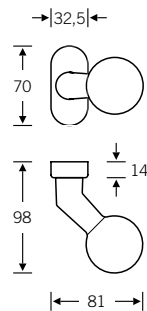

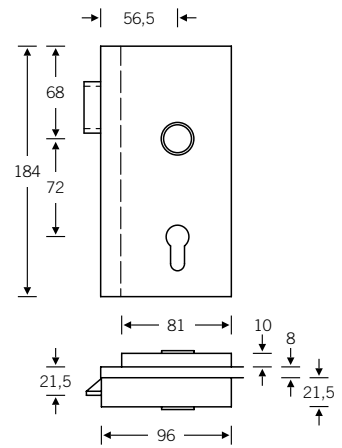

Lever/knob sets

Doorknob for flush doors

Knob backplates

- Aluminium X = 77 mm
- Stainless steel X = 73 mm
- Bronze X = 72 mm

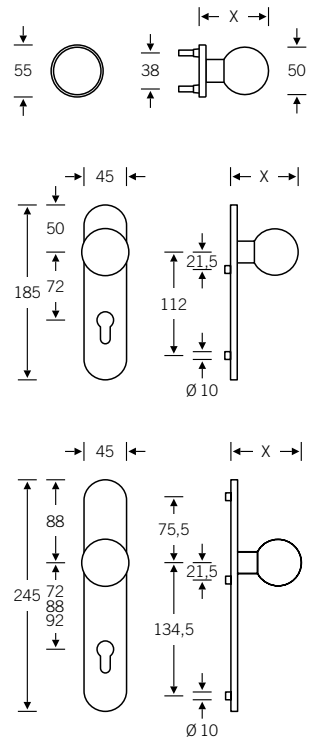

Product codes for the lever/knob sets can be found on the following pages; for individual components, see page 328 ff.

Lever/lever sets

Broad backplate sets available upon request; for flush-fitted roses, see page 536 f.

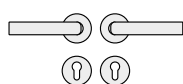

- 🔑 12 1242 013 (N)
- 🔑 72 1242 613 (R)
- 🔑 76 1242 613 (R)
- 🔑 79 1243 613 (R)

- 🔑 12 1242 047 (prv)
- 🔑 72 1242 614 (L)
- 🔑 76 1242 614 (L)
- 🔑 79 1243 614 (L)

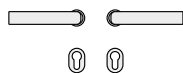

- 🔑 15 1242 013 (N)

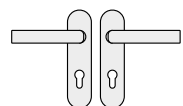

- 🔑 12 1242 007 (N)
- 🔑 72 1242 607 (R)
- 🔑 76 1242 607 (R)
- 🔑 79 1243 607 (R)

- 🔑 72 1242 608 (L)
- 🔑 76 1242 608 (L)
- 🔑 79 1243 608 (L)

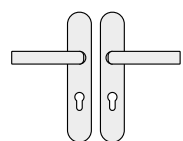

- 🔑 12 1242 027 (N)
- 🔑 72 1242 627 (R)
- 🔑 76 1242 627 (R)
- 🔑 79 1243 627 (R)

- 🔑 72 1242 628 (L)
- 🔑 76 1242 628 (L)
- 🔑 79 1243 628 (L)

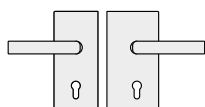

- 🔑 13 4220 041 (R) with 10 1242 00500 (N)
- 🔑 13 4220 042 (R) with 12 1242 013 (N)
- 🔑 13 4220 042 (R) with 72 1242 613 (R)

- 🔑 13 4220 051 (L) with 10 1242 00500 (N)
- 🔑 13 4220 052 (L) with 12 1242 013 (N)
- 🔑 13 4220 052 (L) with 72 1242 614 (L)

Sets for narrow-stile doors

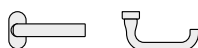

- 🔑 09 1243 111
- 🔑 09 1243 112 (refit to ILS possible)

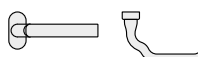

- 🔑 06 1243 011
- 🔑 06 1243 012
- 🔑 06 1243 023 (ILS)



- 07 0846 228 (fixed; aluminium, stainless steel and bronze)
- 🔑 07 0846 428 (fixed; stainless steel and bronze)
- 🔑 07 0846 428 (fixed; aluminium)



- 17 1757

Lever/knob sets

Broad backplate sets available upon request;
for flush-fitted roses, see page 536 f.

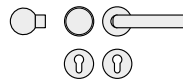

- 12 1242 015 (N)
- 72 1242 615 (R)
- 76 1242 615 (R)
- 79 1243 615 (R)
- 79 1243 619 (ILS)
- 72 1242 616 (L)
- 76 1242 616 (L)
- 79 1243 616 (L)

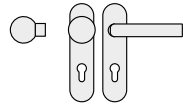

- 12 1242 009 (N)
- 72 1242 609 (R)
- 76 1242 609 (R)
- 79 1243 609 (R)
- 79 1243 611 (ILS)
- 72 1242 610 (L)
- 76 1242 610 (L)
- 79 1243 610 (L)

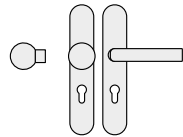

- 12 1242 029 (N)
- 72 1242 629 (R)
- 76 1242 629 (R)
- 79 1243 629 (R)
- 79 1243 631 (ILS)
- 72 1242 630 (L)
- 76 1242 630 (L)
- 79 1243 630 (L)

WC sets

Broad backplate sets available upon request;
for flush-fitted roses, see page 536 f.

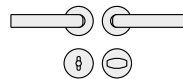

- 12 1242 019 (N)
- 72 1242 619 (R)
- 72 1242 620 (L)

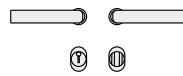

- 15 1242 019 (N)

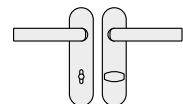

- 12 1242 011 (N)
- 72 1242 611 (R)
- 72 1242 612 (L)

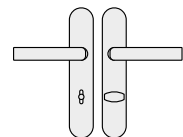

- 12 1242 031 (N)
- 72 1242 631 (R)
- 72 1242 632 (L)

Window handles



- 34 1242 09030 (rose 27 × 62 × 10)
- 34 1242 09039 (rose 32.5 × 70 × 10)
- 34 1242 09034 (rose 25.5 × 60.5 flush-fitted)
- 34 1242 170 (lock adaptor RC 1–6)
- 34 1242 076 (lock adaptor with push-button RC 1–6)
- 34 1242 711 (plug-in handle for timber/metal profiles, Ø 30)
- 34 1242 751 (plug-in handle for PVC profiles, Ø 30)
- 34 1242 011 (lifting/sliding door handle)

N = non-handed
prv = lever handle with privacy function
R = DIN RH, opening inwards
L = DIN LH, opening inwards
ILS = inactive-leaf set

Female handles
Plug-in handle for doors
FSB ASL®

FSB AGL®
FS heavy-duty fitting
EN 179 heavy-duty fitting

For bearings, see page 52 ff.

True to the adage that simple is (usually) best, architectural firm gmp have designed a door handle with particularly pared-down credentials. The FSB 1244 incorporates the simplest of geometric shapes. Its linear front face takes on the curvature of its neck on one end and closes it with a square finish on the other. The grip cross-section is made up of half a circle and half a square, a compound shape that gives the hand something pleasant and substantial to grasp.

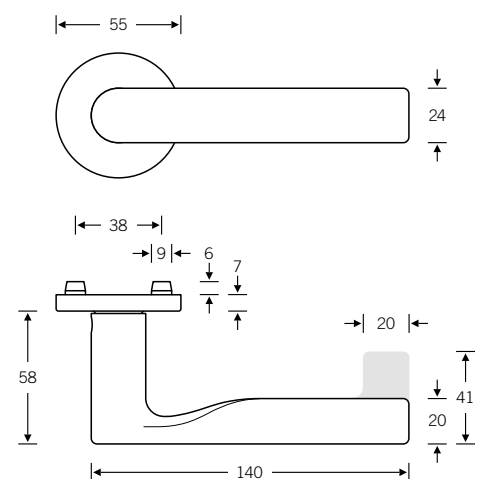

Design: von Gerkan, Marg and Partners (gmp)

 EN 179 model: FSB 1245
 Lever handle with return-to-door

Other variants:
 – square roses
 – oval/angular backplates

Lever handle with privacy function

12 1244

Push-button lock, see page 526 ff.

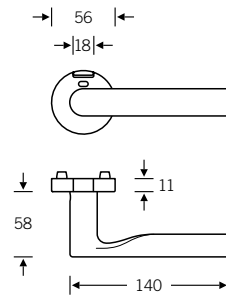

Plug-in handle for doors

15 1244

4

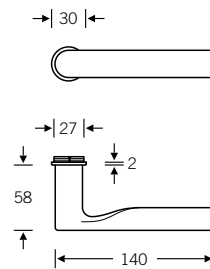

Window handle

Plug-in handle for windows

34 1244

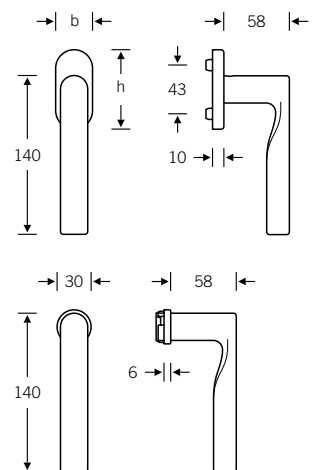

Custom-coordinated lifting/sliding door handle available upon request, see page 10

Lever handles for narrow-stile doors

09 1245 (in-line, EN 179)
06 1245 (cranked, EN 179)

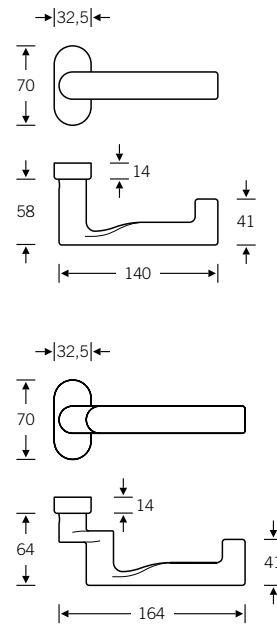

Doorknob for narrow-stile doors

07 0809 (cranked)

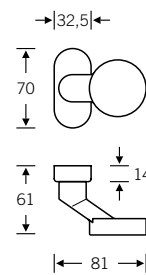

Glass door fitting

13 4220 with 72 1244

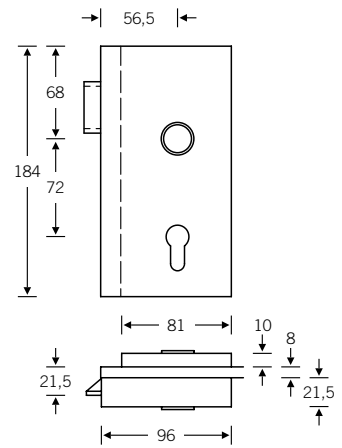

4

Lever/knob sets

Doorknob for flush doors

Knob backplates

Aluminium $\varnothing = 50$
Stainless steel $\varnothing = 55$

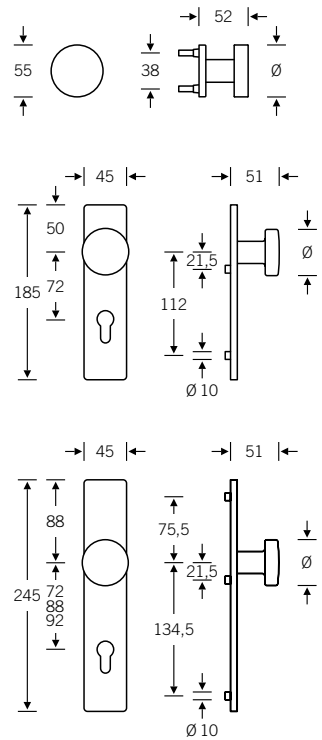

Product codes for the lever/knob sets can be found on the following pages; for individual components, see page 328 ff.

Lever/lever sets

Broad backplate sets available upon request; for flush-fitted roses, see page 536 f.

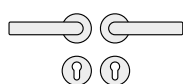

- 🔑 12 1244 013 (N)
- 🔑 72 1244 613 (R)
- 🔑 76 1244 613 (R)
- 🔑 79 1245 613 (R)

- 🔑 12 1244 047 (prv)
- 🔑 72 1244 614 (L)
- 🔑 76 1244 614 (L)
- 🔑 79 1245 614 (L)

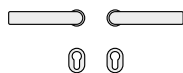

- 🔑 15 1244 013 (N)

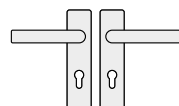

- 🔑 12 1244 001 (N)
- 🔑 72 1244 601 (R)
- 🔑 76 1244 601 (R)
- 🔑 79 1245 601 (R)

- 🔑 72 1244 602 (L)
- 🔑 76 1244 602 (L)
- 🔑 79 1245 602 (L)

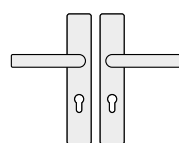

- 🔑 12 1244 021 (N)
- 🔑 72 1244 621 (R)
- 🔑 76 1244 621 (R)
- 🔑 79 1245 621 (R)

- 🔑 72 1244 622 (L)
- 🔑 76 1244 622 (L)
- 🔑 79 1245 622 (L)

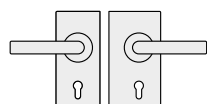

- 🔑 13 4220 041 (R) with 10 1244 00500 (N)
- 🔑 13 4220 042 (R) with 12 1244 013 (N)
- 🔑 13 4220 042 (R) with 72 1244 613 (R)
- 🔑 13 4220 090* with 76 1244 613 (R)
- 🔑 13 4220 090* with 79 1245 913 (N)

- 🔑 13 4220 051 (L) with 10 1244 00500 (N)
- 🔑 13 4220 052 (L) with 12 1244 013 (N)
- 🔑 13 4220 052 (L) with 72 1244 614 (L)
- 🔑 13 4220 090* with 76 1244 614 (L)

Sets for narrow-stile doors

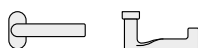

- 🔑 09 1245 111
- 🔑 09 1245 112 (refit to ILS possible)



- 🔑 06 1245 011
- 🔑 06 1245 012

- 🔑 06 1245 023 (ILS)



- 🔑 07 0809 228 (fixed; aluminium and stainless steel)
- 🔑 07 0809 228 (fixed; stainless steel)
- 🔑 07 0809 428 (fixed; aluminium)



- 17 1757

* Fire safety and EN 179 variants available only in stainless steel; for variants, see page 508

Lever/knob sets

Broad backplate sets available upon request; for flush-fitted roses, see page 536 f.

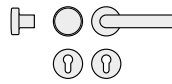

- | | |
|-------------------|-----------------|
| 12 1244 017 (N) | 72 1244 618 (L) |
| 72 1244 617 (R) | 76 1244 618 (L) |
| 76 1244 617 (R) | 79 1245 618 (L) |
| 79 1245 617 (R) | |
| 79 1245 619 (ILS) | |

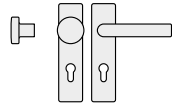

- | | |
|-------------------|-----------------|
| 12 1244 003 (N) | 72 1244 604 (L) |
| 72 1244 603 (R) | 76 1244 604 (L) |
| 76 1244 603 (R) | 79 1245 604 (L) |
| 79 1245 603 (R) | |
| 79 1245 605 (ILS) | |

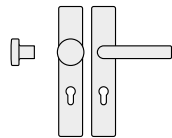

- | | |
|-------------------|-----------------|
| 12 1244 023 (N) | 72 1244 624 (L) |
| 72 1244 623 (R) | 76 1244 624 (L) |
| 76 1244 623 (R) | 79 1245 624 (L) |
| 79 1245 623 (R) | |
| 79 1245 625 (ILS) | |

WC sets

Broad backplate sets available upon request; for flush-fitted roses, see page 536 f.

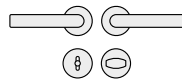

- | | |
|-----------------|-----------------|
| 12 1244 019 (N) | 72 1244 620 (L) |
| 72 1244 619 (R) | |

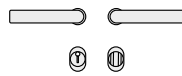

- | |
|-----------------|
| 15 1244 019 (N) |
|-----------------|

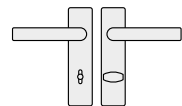

- | | |
|-----------------|-----------------|
| 12 1244 005 (N) | 72 1244 606 (L) |
| 72 1244 605 (R) | |

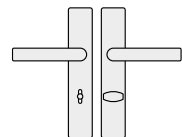

- | | |
|-----------------|-----------------|
| 12 1244 025 (N) | 72 1244 626 (L) |
| 72 1244 625 (R) | |

Window handles

Custom-coordinated lifting/sliding door handle available upon request, see page 10



- 34 1244 09030 (rose 27 × 62 × 10)
- 34 1244 09039 (rose 32.5 × 70 × 10)
- 34 1244 09034 (rose 25.5 × 60.5 flush-fitted)
- 34 1244 170 (lock adaptor RC 1–6)
- 34 1244 076 (lock adaptor with push-button RC 1–6)
- 34 1244 711 (plug-in handle for timber/metal profiles, Ø 30)
- 34 1244 751 (plug-in handle for PVC profiles, Ø 30)
- 34 1244 714 (plug-in handle, lock adaptor RC 1–6)
- 34 1244 717 (plug-in handle with push-button RC 1–6)

N = non-handed
 prv = lever handle with privacy function
 R = DIN RH, opening inwards
 L = DIN LH, opening inwards
 ILS = inactive-leaf set

Female handles
 Plug-in handle for doors
 FSB ASL®

FSB AGL®
 FS heavy-duty fitting
 EN 179 heavy-duty fitting

For bearings, see page 52 ff.

Pared-down design coupled with gleaming ergonomic credentials: the FSB 1246 by GRAFT incorporates style parameters of a wholly new kind. Its narrow radii and generously dimensioned transition curves create points of sculptural momentum and contrast that render the FSB 1246 handle as aesthetically exciting as it is long-lived. Its well-proportioned gripping volume is compellingly palpable, while its clean geometric lines make it ideal for any architectural context.

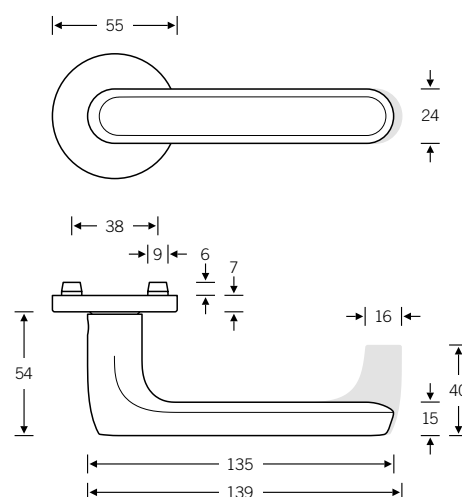

Design: GRAFT

Ⓢ EN 179 model: FSB 1247
 Lever handle with return-to-door

Other variants:
 – square roses
 – oval/angular backplates

Lever handle with privacy function

12 1246

Push-button lock, see page 526 ff.

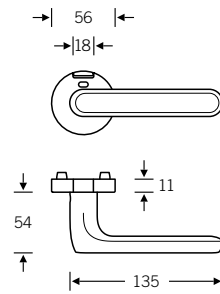

Plug-in handle for doors

15 1246

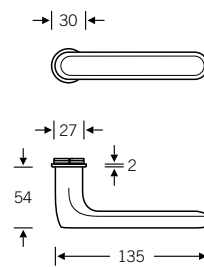

Window handle

Plug-in handle for windows

34 1246

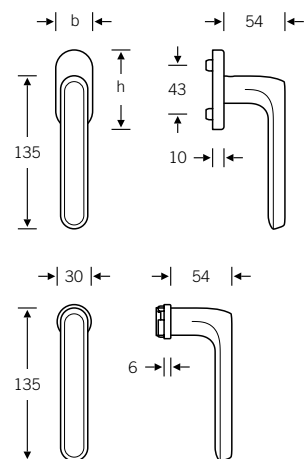

Custom-coordinated lifting/sliding door handle available upon request, see page 10

Lever handles for narrow-stile doors

09 1247 (in-line, EN 179)
06 1247 (cranked, EN 179)

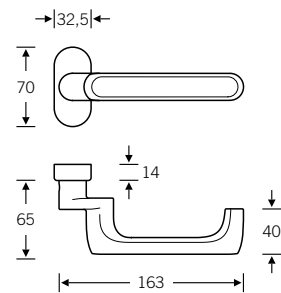
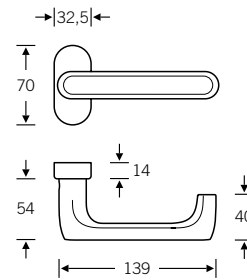

Doorknob for narrow-stile doors

07 0846 (cranked)

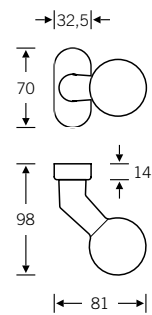

Glass door fitting

13 4223 with 72 1246

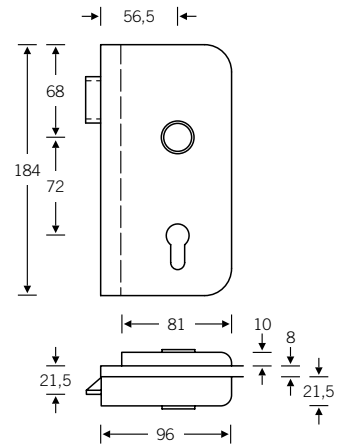

4

Lever/knob sets

Doorknob for flush doors

Knob backplates

Aluminium X = 77 mm

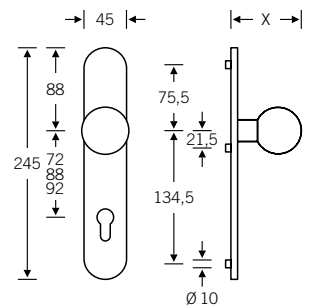
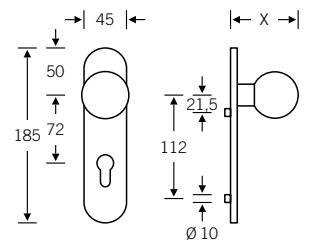
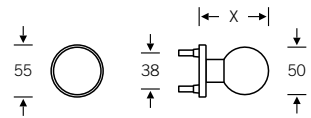

Product codes for the lever/knob sets can be found on the following pages; for individual components, see page 328 ff.

Lever/lever sets

Broad backplate sets available upon request; for flush-fitted roses, see page 536 f.

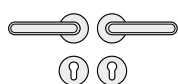

- 12 1246 013 (N)
- 72 1246 613 (R)
- 76 1246 613 (R)
- 79 1247 613 (R)

- 12 1246 047 (prv)
- 72 1246 614 (L)
- 76 1246 614 (L)
- 79 1247 614 (L)

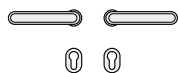

- 15 1246 013 (N)

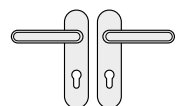

- 12 1246 007 (N)
- 72 1246 607 (R)
- 76 1246 607 (R)
- 79 1247 607 (R)

- 72 1246 608 (L)
- 76 1246 608 (L)
- 79 1247 608 (L)

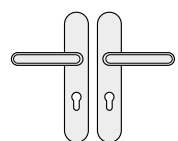

- 12 1246 027 (N)
- 72 1246 627 (R)
- 76 1246 627 (R)
- 79 1247 627 (R)

- 72 1246 628 (L)
- 76 1246 628 (L)
- 79 1247 628 (L)

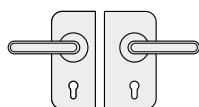

- 13 4223 041 (R) with 10 1246 00500 (N)
- 13 4223 042 (R) with 12 1246 013 (N)
- 13 4223 042 (R) with 72 1246 613 (R)

- 13 4223 051 (L) with 10 1246 00500 (N)
- 13 4223 052 (L) with 12 1246 013 (N)
- 13 4223 052 (L) with 72 1246 614 (L)

Sets for narrow-stile doors



- 09 1247 111
- 09 1247 112 (refit to ILS possible)



- 06 1247 011
- 06 1247 012
- 06 1247 023 (ILS)

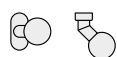

- 07 0846 228 (fixed)
- 07 0846 428 (fixed)



- 17 1757

Lever/knob sets

Broad backplate sets available upon request; for flush-fitted roses, see page 536 f.

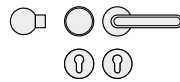

- 12 1246 015 (N)
- 72 1246 615 (R)
- 76 1246 615 (R)
- 79 1247 615 (R)
- 79 1247 619 (ILS)
- 72 1246 616 (L)
- 76 1246 616 (L)
- 79 1247 616 (L)

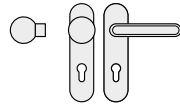

- 12 1246 009 (N)
- 72 1246 609 (R)
- 76 1246 609 (R)
- 79 1247 609 (R)
- 79 1247 611 (ILS)
- 72 1246 610 (L)
- 76 1246 610 (L)
- 79 1247 610 (L)

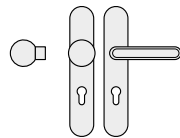

- 12 1246 029 (N)
- 72 1246 629 (R)
- 76 1246 629 (R)
- 79 1247 629 (R)
- 79 1247 631 (ILS)
- 72 1246 630 (L)
- 76 1246 630 (L)
- 79 1247 630 (L)

WC sets

Broad backplate sets available upon request; for flush-fitted roses, see page 536 f.

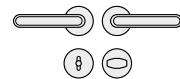

- 12 1246 019 (N)
- 72 1246 619 (R)
- 72 1246 620 (L)

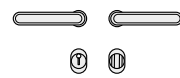

- 15 1246 019 (N)

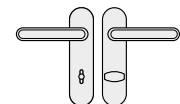

- 12 1246 011 (N)
- 72 1246 611 (R)
- 72 1246 612 (L)

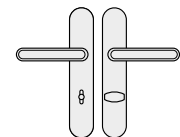

- 12 1246 031 (N)
- 72 1246 631 (R)
- 72 1246 632 (L)

Window handles

Custom-coordinated lifting/sliding door handle available upon request, see page 10



- 34 1246 09030 (rose 27 × 62 × 10)
- 34 1246 09039 (rose 32.5 × 70 × 10)
- 34 1246 09034 (rose 25.5 × 60.5 flush-fitted)
- 34 1246 170 (lock adaptor RC 1–6)
- 34 1246 076 (lock adaptor with push-button RC 1–6)
- 34 1246 711 (plug-in handle for timber/metal profiles, Ø 30)
- 34 1246 751 (plug-in handle for PVC profiles, Ø 30)

N = non-handed
 prv = lever handle with privacy function
 R = DIN RH, opening inwards
 L = DIN LH, opening inwards
 ILS = inactive-leaf set

Female handles
 Plug-in handle for doors
 FSB ASL®

FSB AGL®
 FS heavy-duty fitting
 EN 179 heavy-duty fitting

For bearings, see page 52 ff.

The FSB 1251 conjures up images of 'square, practical and good', though its design is best summed up in the words of the great master himself: 'Rectangular, no-frills design defined solely by proportional contrasts – a miniature architectural counterpart to soberly planned houses. Supreme manufacturing precision reinforces the design's clarity.' (Hartmut Weise)

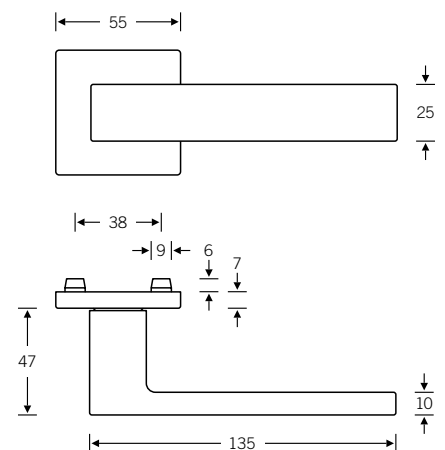
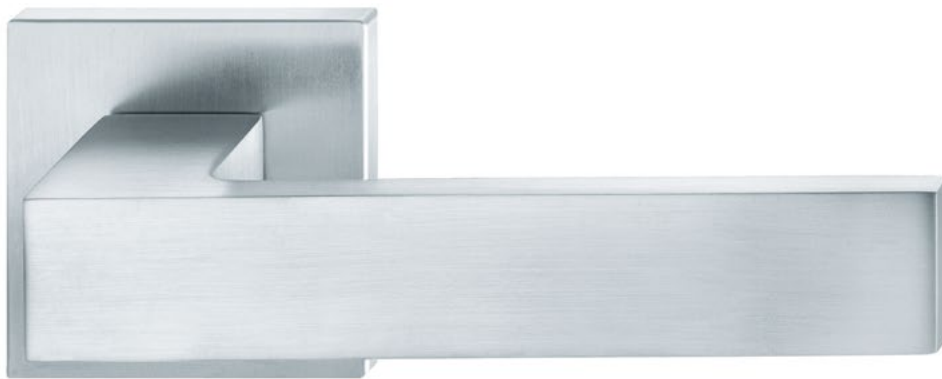

Design: Hartmut Weise

Other variants:
– round roses
– oval/angular backplates

Lever handle with privacy function

12 1251

Push-button lock, see page 526 ff.

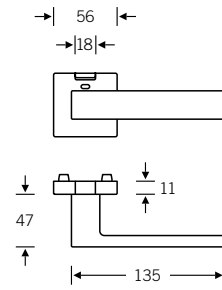

Window handle

34 1251

4

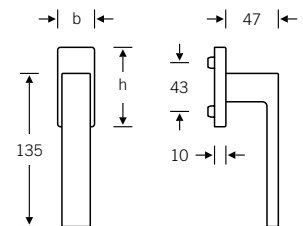

Lever/lever sets

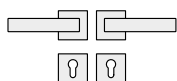

➤ 12 1251 041 (N)

➤ 12 1251 049 (prv)

Broad backplate sets available upon request

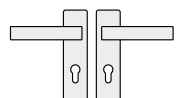

➤ 12 1251 001 (N)

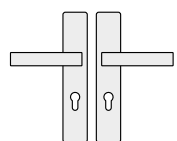

➤ 12 1251 021 (N)

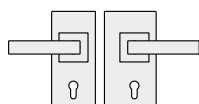

➤ 13 4220 042 (R) with
12 1241 041 (N)

➤ 13 4220 052 (L) with
12 1241 041 (N)

Lever/knob sets

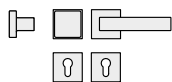

➤ 12 1251 043 (N)

Broad backplate sets available upon request;
for associated knobs, see page 328 f.

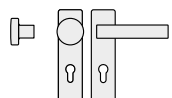

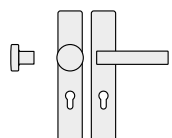

➤ 12 1251 003 (N)

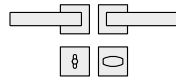

➤ 12 1251 023 (N)

WC sets



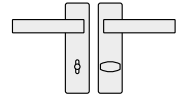

 12 1251 045 (N)

Broad backplate sets available upon request

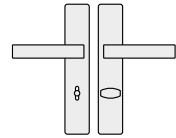

 12 1251 005 (N)





 12 1251 025 (N)



Window handles



34 1251 09032 (rose 27 × 62 × 10)
34 1251 09040 (rose 32.5 × 70 × 10)
34 1251 09036 (rose 25.5 × 60.5 flush-fitted)
34 1251 180 (lock adaptor RC 1–6)
34 1251 086 (lock adaptor with push-button RC1–6)

N = non-handed
prv = lever handle with privacy function
R = DIN RH, opening inwards
L = DIN LH, opening inwards
ILS = inactive-leaf set

 Female handles
 Plug-in handle for doors
 FSB ASL®

 FSB AGL®
 FS heavy-duty fitting
 EN 179 heavy-duty fitting

For bearings, see page 52 ff.

A study of historical handles led Fawad Kazi to come up with a universal lever handle through a process of rigorous reduction. The FSB 1254 combines the traditional emphasis on substantial grip with an unembellished stylistic approach. The handle's cross-section sees circle meet square and embodies classical ideals of architecture.

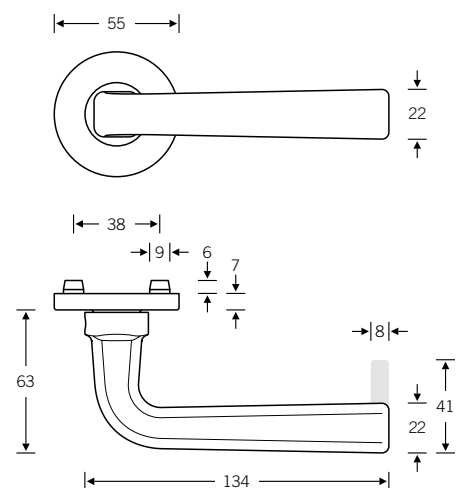

Design: Fawad Kazi

Ⓢ EN 179 model: FSB 1255
 Lever handle with return-to-door

Other variants:
 – square roses
 – oval/angular backplates

Lever handle with privacy function

12 1254

Push-button lock, see page 526 ff.

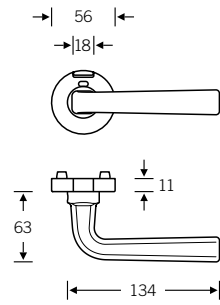

Plug-in handle for doors

15 1254

4

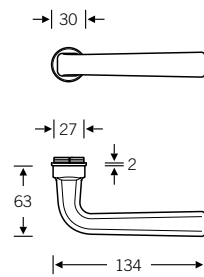

Window handle

34 1254
34 3454

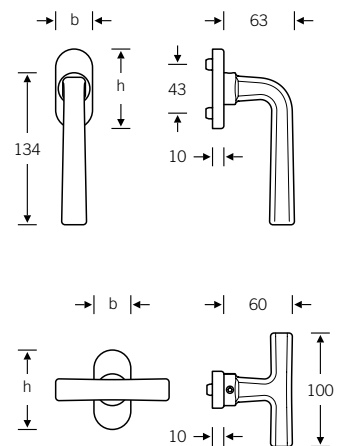

Lever handles for narrow-stile doors

09 1255 (in-line, EN 179)
06 1255 (cranked, EN 179)

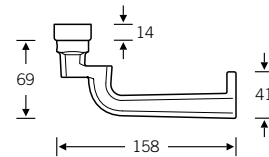
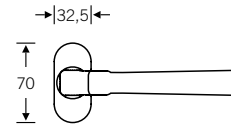
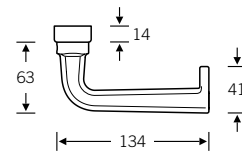
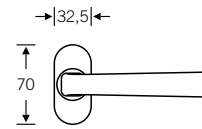

Doorknob for narrow-stile doors

07 0809 (cranked)

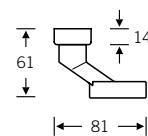
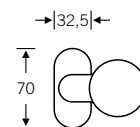

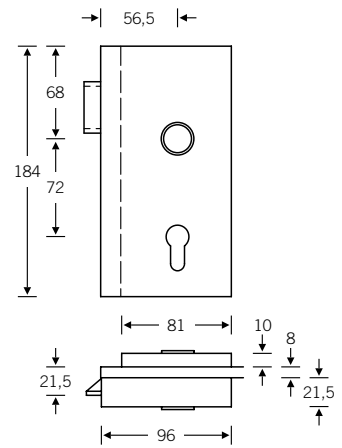

Lever/knob sets

Doorknob for flush doors

Knob backplates

Stainless steel
Ø = 55

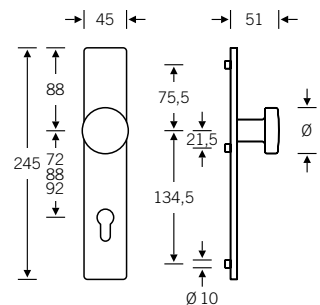
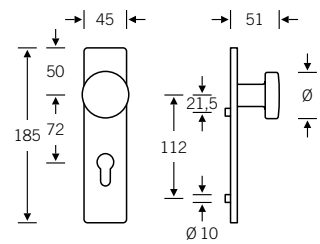
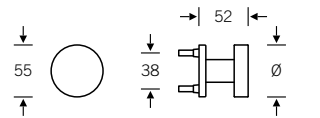

Product codes for the lever/knob sets can be found on the following pages; for individual components, see page 328 ff.

Lever/lever sets

Broad backplate sets available upon request; for flush-fitted roses, see page 536 f.

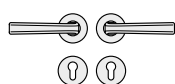

- 12 1254 013 (N)
- 72 1254 613 (R)
- 76 1254 613 (R)
- 79 1255 613 (R)

- 12 1254 047 (prv)
- 72 1254 614 (L)
- 76 1254 614 (L)
- 79 1255 614 (L)

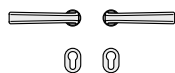

- 15 1254 013 (N)

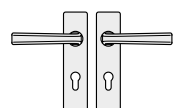

- 12 1254 001 (N)
- 72 1254 601 (R)
- 76 1254 601 (R)
- 79 1255 601 (R)

- 72 1254 602 (L)
- 76 1254 602 (L)
- 79 1255 602 (L)

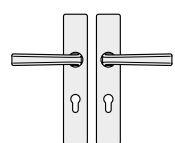

- 12 1254 021 (N)
- 72 1254 621 (R)
- 76 1254 621 (R)
- 79 1255 621 (R)

- 72 1254 622 (L)
- 76 1254 622 (L)
- 79 1255 622 (L)

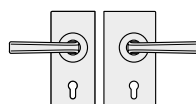

- 13 4220 042 (R) with 12 1254 013 (N)
- 13 4220 042 (R) with 72 1254 613 (R)
- 13 4220 090* with 76 1254 613 (R)
- 13 4220 090* with 79 1255 913 (N)

- 13 4220 052 (L) with 12 1254 013 (N)
- 13 4220 052 (L) with 72 1254 614 (L)
- 13 4220 090* with 76 1254 614 (L)

Sets for narrow-stile doors

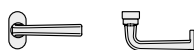

- 09 1255 111
- 09 1255 112 (refit to ILS possible)

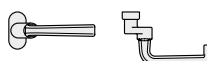

- 06 1255 011
- 06 1255 012
- 06 1255 023 (ILS)



- 07 0809 228 (fixed)
- 07 0809 228 (fixed)



- 17 1757

* Fire safety and EN 179 variants available only in stainless steel; for variants, see page 508

Lever/knob sets

Broad backplate sets available upon request;
for flush-fitted roses, see page 536 f.

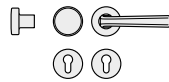

- 12 1254 017 (N)
- 72 1254 617 (R)
- 76 1254 617 (R)
- 79 1255 617 (R)
- 79 1255 619 (ILS)
- 72 1254 618 (L)
- 76 1254 618 (L)
- 79 1255 618 (L)

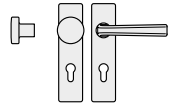

- 12 1254 003 (N)
- 72 1254 603 (R)
- 76 1254 603 (R)
- 79 1255 603 (R)
- 79 1255 605 (ILS)
- 72 1254 604 (L)
- 76 1254 604 (L)
- 79 1255 604 (L)

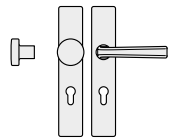

- 12 1254 023 (N)
- 72 1254 623 (R)
- 76 1254 623 (R)
- 79 1255 623 (R)
- 79 1255 625 (ILS)
- 72 1254 624 (L)
- 76 1254 624 (L)
- 79 1255 624 (L)

WC sets

Broad backplate sets available upon request;
for flush-fitted roses, see page 536 f.

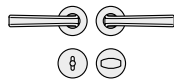

- 12 1254 019 (N)
- 72 1254 619 (R)
- 72 1254 620 (L)

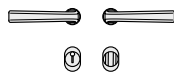

- 15 1254 019 (N)

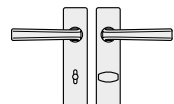

- 12 1254 005 (N)
- 72 1254 605 (R)
- 72 1254 606 (L)

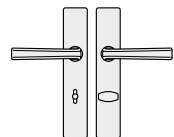

- 12 1254 025 (N)
- 72 1254 625 (R)
- 72 1254 626 (L)

Window handles

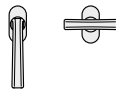

- 34 1254 09030 (rose 27 × 62 × 10)
- 34 1254 09039 (rose 32.5 × 70 × 10)
- 34 1254 09034 (rose 25.5 × 60.5 flush-fitted)
- 34 1254 170 (lock adaptor RC 1–6)
- 34 1254 076 (lock adaptor with push-button RC 1–6)
- 34 3454 09039 (tee handle for window)

N = non-handed
prv = lever handle with privacy function
R = DIN RH, opening inwards
L = DIN LH, opening inwards
ILS = inactive-leaf set

Female handles
Plug-in handle for doors
FSB ASL®

FSB AGL®
FS heavy-duty fitting
EN 179 heavy-duty fitting

For bearings, see page 52 ff.

FSB pays tribute to the revered Ludwig Mies van der Rohe with this design. The FSB 1267 is more than just a replica of an original Mies van der Rohe lever handle, however. While retaining the formal thrust of its forebears, our interpretation also conforms to present-day standards and the requirements of modern architecture – now in stainless steel.

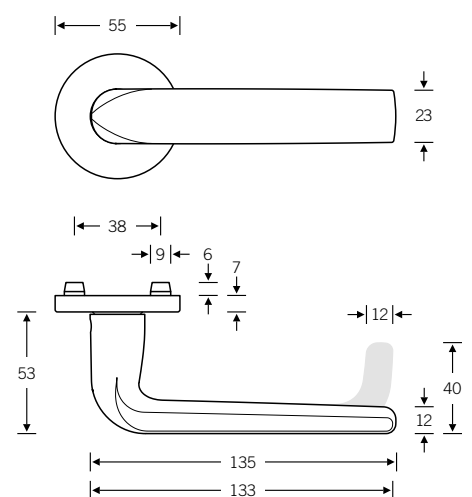

Design: Hartmut Weise

 EN 179 model: FSB 1268
 Lever handle with return-to-door

Other variants:
 – square roses
 – oval/angular backplates

Lever handle with privacy function

12 1267

Push-button lock, see page 526 ff.

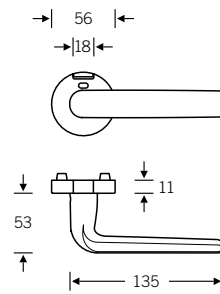

Plug-in handle for doors

15 1267

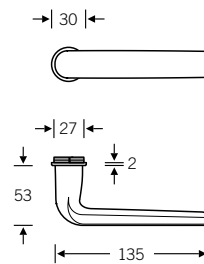

Window handle

Plug-in handle for windows

34 1267

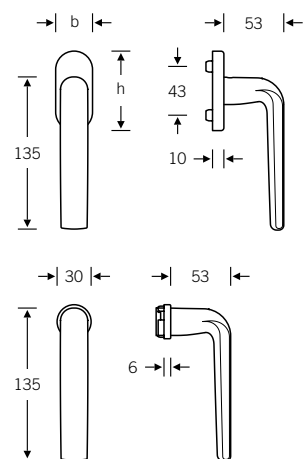

Custom-coordinated lifting/sliding door handle available upon request, see page 10

Lever handles for narrow-stile doors

09 1268 (in-line, EN 179)
06 1268 (cranked, EN 179)

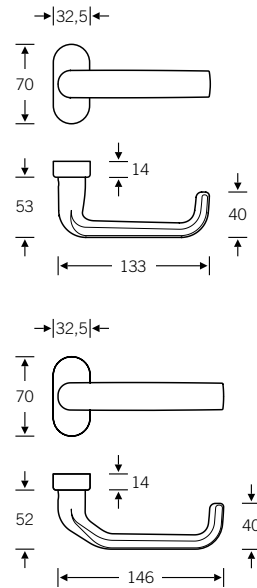

Doorknob for narrow-stile doors

07 0809 (cranked)

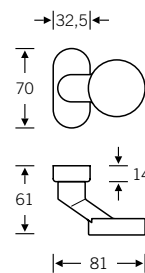

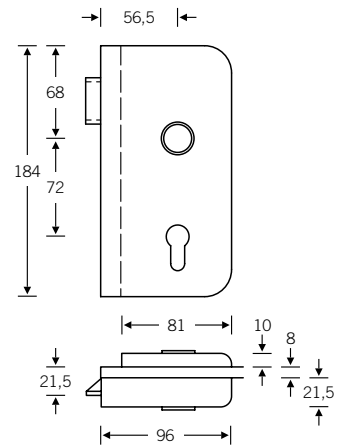

Lever/knob sets

Doorknob for flush doors

- Aluminium Ø = 50
- Stainless steel Ø = 55
- Bronze Ø = 50

Knob backplates

- Aluminium X = 77 mm
- Stainless steel X = 73 mm
- Bronze X = 72 mm

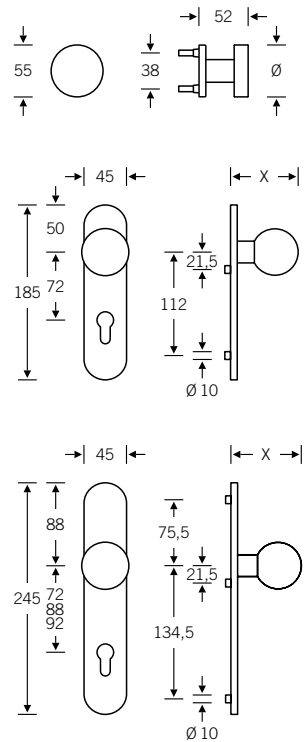
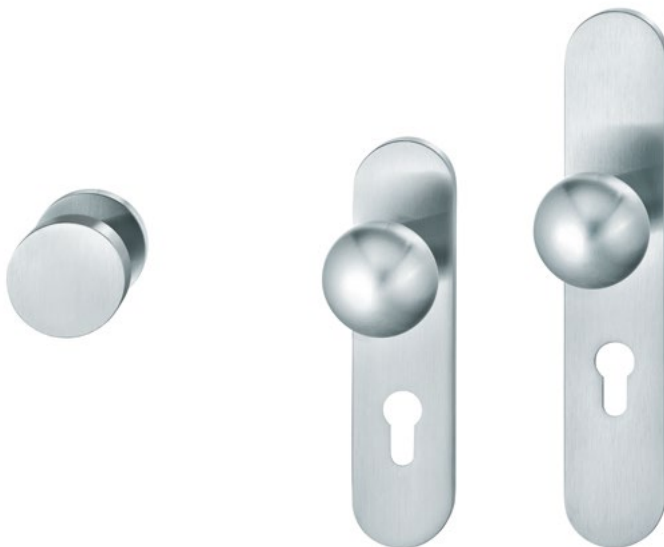

Product codes for the lever/knob sets can be found on the following pages; for individual components, see page 328 ff.

Lever/lever sets

Broad backplate sets available upon request; for flush-fitted roses, see page 536 f.

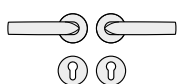

- 12 1267 013 (N)
- 72 1267 613 (R)
- 76 1267 613 (R)
- 79 1268 613 (R)

- 12 1267 047 (prv)
- 72 1267 614 (L)
- 76 1267 614 (L)
- 79 1268 614 (L)

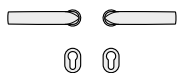

- 15 1267 013 (N)

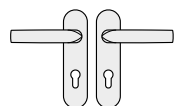

- 12 1267 007 (N)
- 72 1267 607 (R)
- 76 1267 607 (R)
- 79 1268 607 (R)

- 72 1267 608 (L)
- 76 1267 608 (L)
- 79 1268 608 (L)

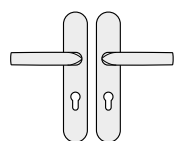

- 12 1267 027 (N)
- 72 1267 627 (R)
- 76 1267 627 (R)
- 79 1268 627 (R)

- 72 1267 628 (L)
- 76 1267 628 (L)
- 79 1268 628 (L)

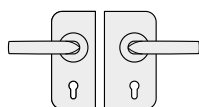

- 13 4223 041 (R) with 10 1267 00500 (N)
- 13 4223 042 (R) with 12 1267 013 (N)
- 13 4223 042 (R) with 72 1267 613 (R)

- 13 4223 051 (L) with 10 1267 00500 (N)
- 13 4223 052 (L) with 12 1267 013 (N)
- 13 4223 052 (L) with 72 1267 614 (L)

Sets for narrow-stile doors



- 09 1268 111
- 09 1268 112 (refit to ILS possible)

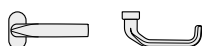

- 06 1268 011
- 06 1268 012
- 06 1268 023 (ILS)



- 07 0809 228 (fixed; aluminium and stainless steel)
- 07 0809 228 (fixed; stainless steel)
- 07 0809 428 (fixed; aluminium)

For set in bronze with knob 07 0846, see page 481



- 17 1757

Lever/knob sets

Broad backplate sets available upon request; for flush-fitted roses, see page 536 f.

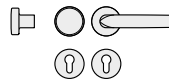

- 12 1267 017 (N)
- 72 1267 617 (R)
- 76 1267 617 (R)
- 79 1268 617 (R)
- 79 1268 619 (ILS)
- 72 1267 618 (L)
- 76 1267 618 (L)
- 79 1268 618 (L)

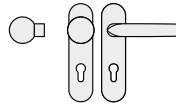

- 12 1267 009 (N)
- 72 1267 609 (R)
- 76 1267 609 (R)
- 79 1268 609 (R)
- 79 1268 611 (ILS)
- 72 1267 610 (L)
- 76 1267 610 (L)
- 79 1268 610 (L)

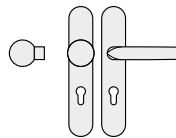

- 12 1267 029 (N)
- 72 1267 629 (R)
- 76 1267 629 (R)
- 79 1268 629 (R)
- 79 1268 631 (ILS)
- 72 1267 630 (L)
- 76 1267 630 (L)
- 79 1268 630 (L)

WC sets

Broad backplate sets available upon request; for flush-fitted roses, see page 536 f.

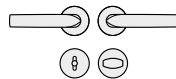

- 12 1267 019 (N)
- 72 1267 619 (R)
- 72 1267 620 (L)

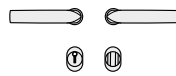

- 15 1267 019 (N)

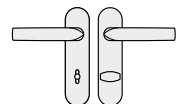

- 12 1267 011 (N)
- 72 1267 611 (R)
- 72 1267 612 (L)

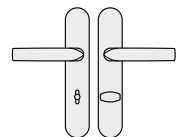

- 12 1267 031 (N)
- 72 1267 631 (R)
- 72 1267 632 (L)

Window handles

Custom-coordinated lifting/sliding door handle available upon request, see page 10



- 34 1267 09030 (rose 27 × 62 × 10)
- 34 1267 09039 (rose 32.5 × 70 × 10)
- 34 1267 09034 (rose 25.5 × 60.5 flush-fitted)
- 34 1267 170 (lock adaptor RC 1–6)
- 34 1267 076 (lock adaptor with push-button RC 1–6)
- 34 1267 711 (plug-in handle for timber/metal profiles, Ø 30)
- 34 1267 751 (plug-in handle for PVC profiles, Ø 30)

N = non-handed
 prv = lever handle with privacy function
 R = DIN RH, opening inwards
 L = DIN LH, opening inwards
 ILS = inactive-leaf set

Female handles
 Plug-in handle for doors
 FSB ASL®

FSB AGL®
 FS heavy-duty fitting
 EN 179 heavy-duty fitting

For bearings, see page 52 ff.

Architect Jürgen Engel has come up with a collection of door and window handles that are single-mindedly geared towards the needs of modern civic/commercial construction and are conducive to a maximum in visual continuity. Conspicuously, the geometry of the various door handles is virtually identical to that of the window handles. With its flat curving front face and gently rounded area at the back, the FSB 1271 fuses precision and comfort.

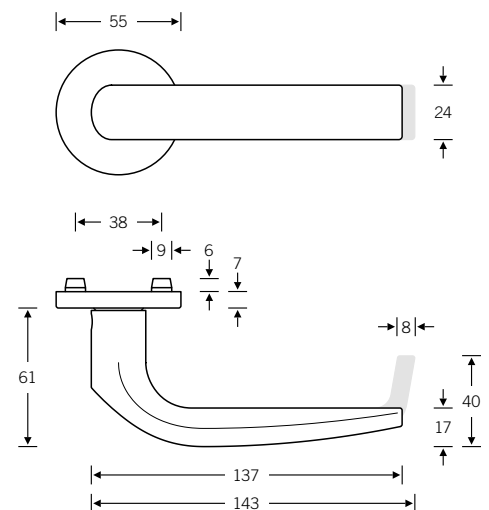

Design: Jürgen Engel

 EN 179 model: FSB 1272
 Lever handle with return-to-door

Other variants:
 – square roses
 – oval/angular backplates

Lever handle with privacy function

12 1271

Push-button lock, see page 526 ff.

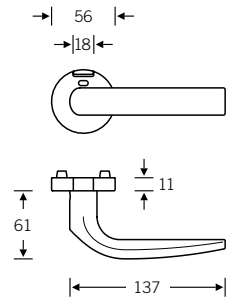

Plug-in handle for doors

15 1271

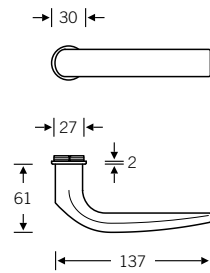

Window handle

Plug-in handle for windows

34 1271

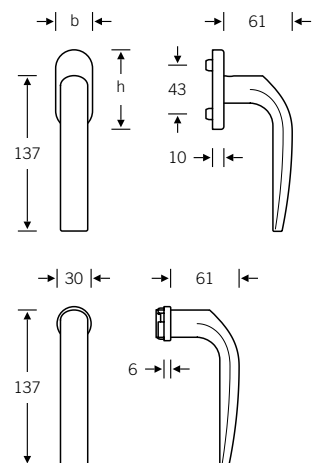

Lever handles for narrow-stile doors

06 1272 (cranked, EN 179)

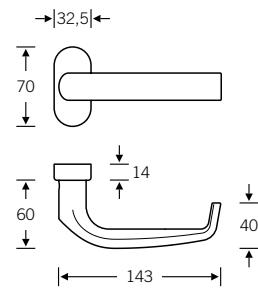

Doorknob for narrow-stile doors

07 0809 (cranked)

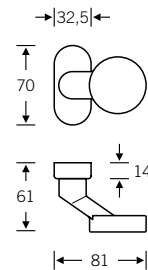

Glass door fitting

13 4220 with 10 1271

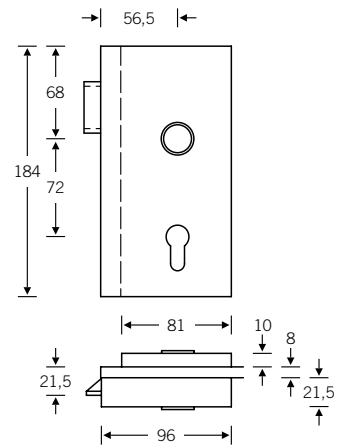

4

Lever/knob sets

Doorknob for flush doors

Knob backplates

Aluminium $\varnothing = 50$
Stainless steel $\varnothing = 55$

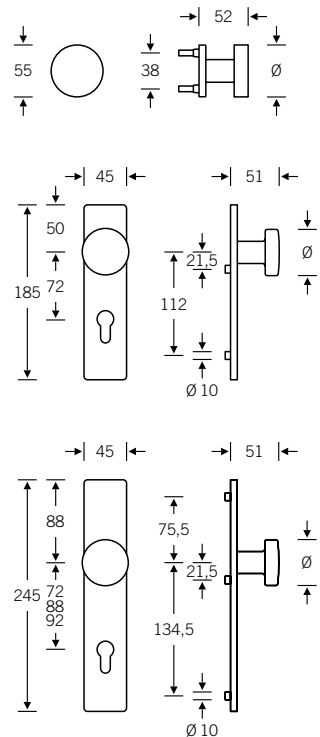

Product codes for the lever/knob sets can be found on the following pages; for individual components, see page 328 ff.

Lever/lever sets

Broad backplate sets available upon request; for flush-fitted roses, see page 536 f.

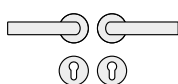

- 12 1271 013 (N)
- 72 1271 613 (R)
- 76 1271 613 (R)
- 79 1272 613 (R)

- 12 1271 047 (prv)
- 72 1271 614 (L)
- 76 1271 614 (L)
- 79 1272 614 (L)

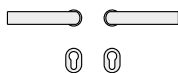

- 15 1271 013 (N)

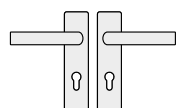

- 12 1271 001 (N)
- 72 1271 601 (R)
- 76 1271 601 (R)
- 79 1272 601 (R)

- 72 1271 602 (L)
- 76 1271 602 (L)
- 79 1272 602 (L)

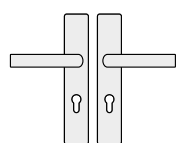

- 12 1271 021 (N)
- 72 1271 621 (R)
- 76 1271 621 (R)
- 79 1272 621 (R)

- 72 1271 622 (L)
- 76 1271 622 (L)
- 79 1272 622 (L)

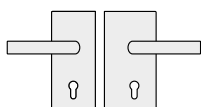

- 13 4220 041 (R) with 12 1271 00500 (N)
- 13 4220 042 (R) with 12 1271 013 (N)
- 13 4220 042 (R) with 72 1271 613 (R)
- 13 4220 090* with 76 1271 613 (R)
- 13 4220 090* with 79 1272 913 (N)

- 13 4220 051 (L) with 12 1271 00500 (N)
- 13 4220 052 (L) with 12 1271 013 (N)
- 13 4220 052 (L) with 72 1271 614 (L)
- 13 4220 090* with 76 1271 614 (L)

Sets for narrow-stile doors

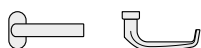

- 06 1272 012

- 06 1272 023 (ILS)



- 07 0809 228 (fixed; aluminium and stainless steel)
- 07 0809 228 (fixed; stainless steel)
- 07 0809 428 (fixed; aluminium)



- 17 1757

* Fire safety and EN 179 variants available only in stainless steel; for variants, see page 508

Lever/knob sets

Broad backplate sets available upon request;
for flush-fitted roses, see page 536 f.

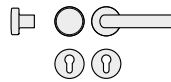

- | | |
|-------------------|-----------------|
| 12 1271 017 (N) | 72 1271 618 (L) |
| 72 1271 617 (R) | 76 1271 618 (L) |
| 76 1271 617 (R) | 79 1272 618 (L) |
| 79 1272 617 (R) | |
| 79 1272 619 (ILS) | |

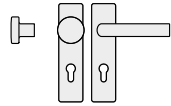

- | | |
|-------------------|-----------------|
| 12 1271 003 (N) | 72 1271 604 (L) |
| 72 1271 603 (R) | 76 1271 604 (L) |
| 76 1271 603 (R) | 79 1272 604 (L) |
| 79 1272 603 (R) | |
| 79 1272 605 (ILS) | |

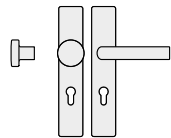

- | | |
|-------------------|-----------------|
| 12 1271 023 (N) | 72 1271 624 (L) |
| 72 1271 623 (R) | 76 1271 624 (L) |
| 76 1271 623 (R) | 79 1272 624 (L) |
| 79 1272 623 (R) | |
| 79 1272 625 (ILS) | |

WC sets

Broad backplate sets available upon request;
for flush-fitted roses, see page 536 f.

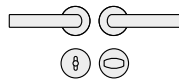

- | | |
|-----------------|-----------------|
| 12 1271 019 (N) | 72 1271 620 (L) |
| 72 1271 619 (R) | |

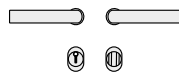

- | |
|-----------------|
| 15 1271 019 (N) |
|-----------------|

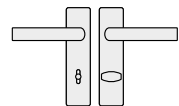

- | | |
|-----------------|-----------------|
| 12 1271 005 (N) | 72 1271 606 (L) |
| 72 1271 605 (R) | |

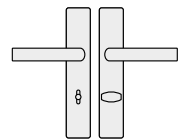

- | | |
|-----------------|-----------------|
| 12 1271 025 (N) | 72 1271 626 (L) |
| 72 1271 625 (R) | |

Window handles



- 34 1271 09030 (rose 27 × 62 × 10)
- 34 1271 09039 (rose 32.5 × 70 × 10)
- 34 1271 09034 (rose 25.5 × 60.5 flush-fitted)
- 34 1271 170 (lock adaptor RC 1–6)
- 34 1271 076 (lock adaptor with push-button RC 1–6)
- 34 1271 711 (plug-in handle for timber/metal profiles, Ø 30)
- 34 1271 751 (plug-in handle for PVC profiles, Ø 30)

N = non-handed
 prv = lever handle with privacy function
 R = DIN RH, opening inwards
 L = DIN LH, opening inwards
 ILS = inactive-leaf set

Female handles
 Plug-in handle for doors
 FSB ASL®

FSB AGL®
 FS heavy-duty fitting
 EN 179 heavy-duty fitting

For bearings, see page 52 ff.

Sleek elegance meets slim-line shapeliness: The FSB 1285 by Matteo Thun and Antonio Rodriguez is a classic example of timeless design that makes compelling play of simplicity, adaptability and judiciously conceived detail. The designers have succeeded in lending shape to a handle whose formal credentials fulfil the various technical requirements for fire and narrow-stile doors in a single end-to-end design.

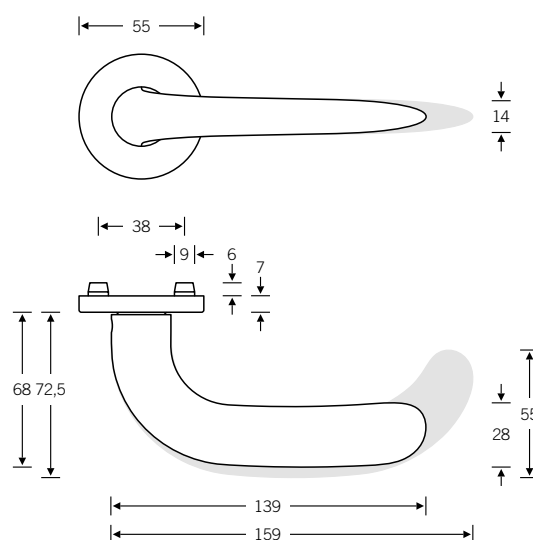

Design: Matteo Thun and Antonio Rodriguez

🔒 EN 179 model: FSB 1286
 Lever handle with return-to-door

Other variants:
 – square roses
 – oval/angular backplates

Lever handle with privacy function

12 1285

Push-button lock, see page 526 ff.

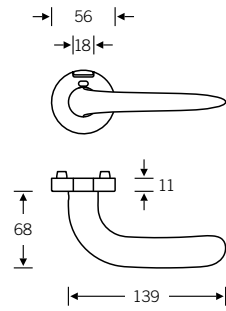

Plug-in handle for doors

15 1285

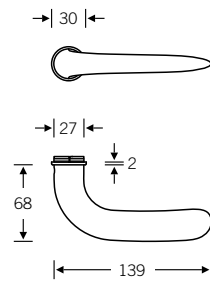

Window handle

Plug-in handle for windows

34 1285

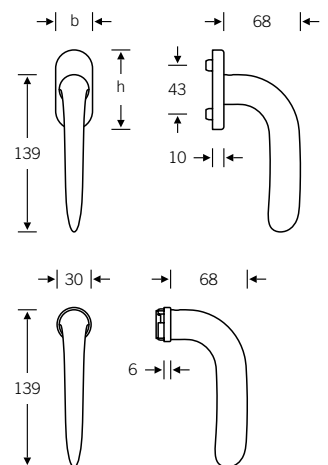

Lever handles for narrow-stile doors

09 1286 (in-line, EN 179)
06 1286 (cranked, EN 179)

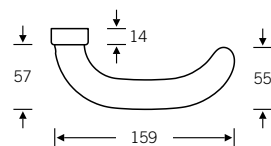
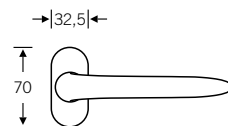
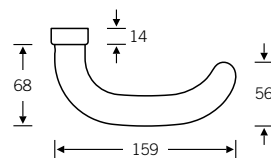
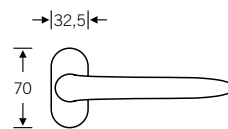

Doorknob for narrow-stile doors

07 0809 (cranked)

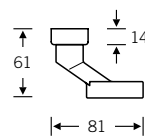
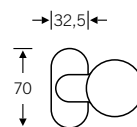

Glass door fitting

13 4220 with 10 1285

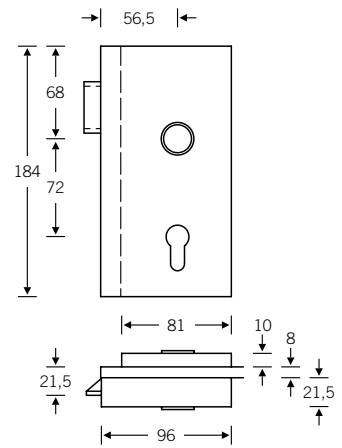

4

Lever/knob sets

Doorknob for flush doors

Knob backplates

Aluminium $\varnothing = 50$

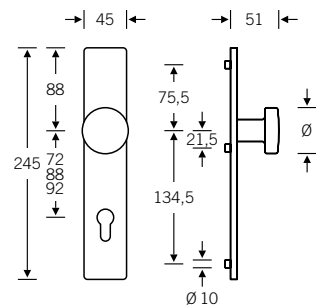
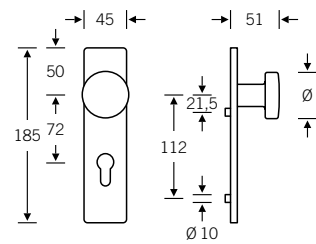
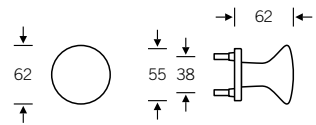

Product codes for the lever/knob sets can be found on the following pages; for individual components, see page 328 ff.

Lever/lever sets

Broad backplate sets available upon request; for flush-fitted roses, see page 536 f.

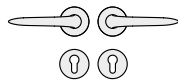

- 🔑 12 1285 013 (N)
- 🔑 72 1285 613 (R)
- 🔑 76 1285 613 (R)
- 🔑 79 1286 613 (R)

- 🔑 12 1285 047 (prv)
- 🔑 72 1285 614 (L)
- 🔑 76 1285 614 (L)
- 🔑 79 1286 614 (L)

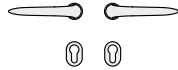

- 🔑 15 1285 013 (N)

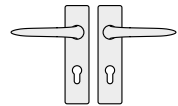

- 🔑 12 1285 001 (N)
- 🔑 72 1285 601 (R)
- 🔑 76 1285 601 (R)
- 🔑 79 1286 601 (R)

- 🔑 72 1285 602 (L)
- 🔑 76 1285 602 (L)
- 🔑 79 1286 602 (L)

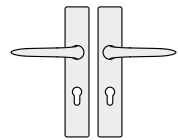

- 🔑 12 1285 021 (N)
- 🔑 72 1285 621 (R)
- 🔑 76 1285 621 (R)
- 🔑 79 1286 621 (R)

- 🔑 72 1285 622 (L)
- 🔑 76 1285 622 (L)
- 🔑 79 1286 622 (L)

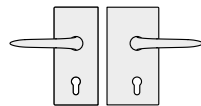

- 🔑 13 4220 041 (R) with 10 1285 00500 (N)
- 🔑 13 4220 042 (R) with 12 1285 013 (N)
- 🔑 13 4220 042 (R) with 72 1285 613 (R)

- 🔑 13 4220 051 (L) with 10 1285 00500 (N)
- 🔑 13 4220 052 (L) with 12 1285 013 (N)
- 🔑 13 4220 052 (L) with 72 1285 614 (L)

Sets for narrow-stile doors

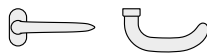

- 🔑 09 1286 111
- 🔑 09 1286 112 (refit to ILS possible)

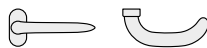

- 🔑 06 1286 011
- 🔑 06 1286 012

- 🔑 06 1286 023 (ILS)



- 07 0809 228 (fixed)
- 🔑 07 0809 428 (fixed)



- 17 1757

Lever/knob sets

Broad backplate sets available upon request; for flush-fitted roses, see page 536 f.

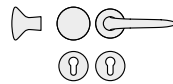

- | | |
|-------------------|-----------------|
| 12 1285 017 (N) | 72 1285 618 (L) |
| 72 1285 617 (R) | 76 1285 618 (L) |
| 76 1285 617 (R) | 79 1286 618 (L) |
| 79 1286 617 (R) | |
| 79 1286 619 (ILS) | |

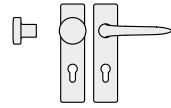

- | | |
|-------------------|-----------------|
| 12 1285 003 (N) | 72 1285 604 (L) |
| 72 1285 603 (R) | 76 1285 604 (L) |
| 76 1285 603 (R) | 79 1286 604 (L) |
| 79 1286 603 (R) | |
| 79 1286 605 (ILS) | |

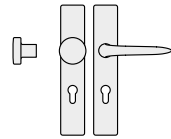

- | | |
|-------------------|-----------------|
| 12 1285 023 (N) | 72 1285 624 (L) |
| 72 1285 623 (R) | 76 1285 624 (L) |
| 76 1285 623 (R) | 79 1286 624 (L) |
| 79 1286 623 (R) | |
| 79 1286 625 (ILS) | |

WC sets

Broad backplate sets available upon request; for flush-fitted roses, see page 536 f.

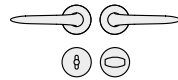

- | | |
|-----------------|-----------------|
| 12 1285 019 (N) | 72 1285 620 (L) |
| 72 1285 619 (R) | |

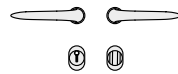

- | |
|-----------------|
| 15 1285 019 (N) |
|-----------------|

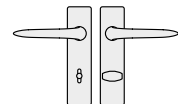

- | | |
|-----------------|-----------------|
| 12 1285 005 (N) | 72 1285 606 (L) |
| 72 1285 605 (R) | |

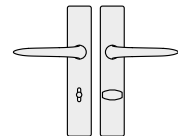

- | | |
|-----------------|-----------------|
| 12 1285 025 (N) | 72 1285 626 (L) |
| 72 1285 625 (R) | |

Window handles



- 34 1285 09030 (rose 27 × 62 × 10)
- 34 1285 09039 (rose 32.5 × 70 × 10)
- 34 1285 09034 (rose 25.5 × 60.5 flush-fitted)
- 34 1285 170 (lock adaptor RC 1–6)
- 34 1285 076 (lock adaptor, with push-button RC 1–6)
- 34 1285 711 (plug-in handle for timber/metal profiles, Ø 30)
- 34 1285 751 (plug-in handle for PVC profiles, Ø 30)

N = non-handed
 prv = lever handle with privacy function
 R = DIN RH, opening inwards
 L = DIN LH, opening inwards
 ILS = inactive-leaf set

Female handles
 Plug-in handle for doors
 FSB ASL®

FSB AGL®
 FS heavy-duty fitting
 EN 179 heavy-duty fitting

For bearings, see page 52 ff.

Accessories

Coat hooks

- 36 3693 00004 (coat hook Ø 45 mm)
- 36 3692 00004 (coat hook Ø 59 mm)
- 36 3693 00000 (coat hook Ø 45 mm, including additional hooks)

Fastened using accompanying M6 screws (furniture screw for drilling and stud screw for attaching)

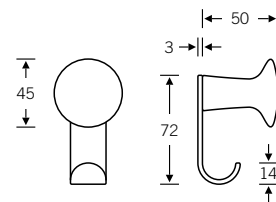
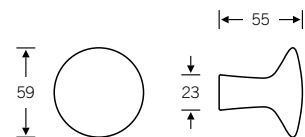
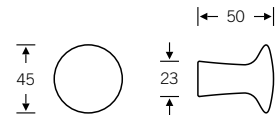

Cabinet knob

- 36 3694 00004 (cabinet knob)

Fastened using accompanying M4 screws (furniture screw for drilling)

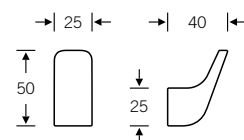
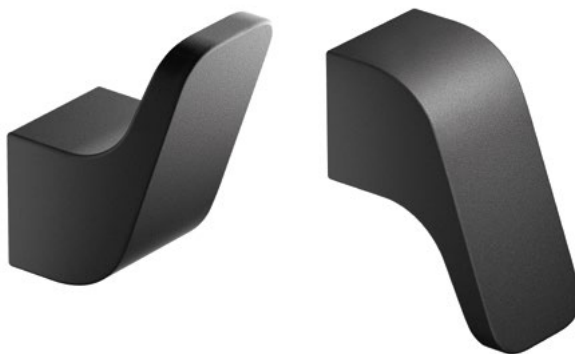

Numbers and number holder



Numbers
38 4006

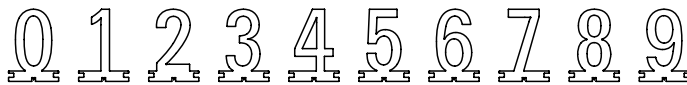

| | | | | | | | | | |
|-------|-------|-------|-------|-------|-------|-------|-------|-------|-------|
| 00000 | 00001 | 00002 | 00003 | 00004 | 00005 | 00006 | 00007 | 00008 | 00009 |
| X=38 | X=19 | X=36 | X=34 | X=41 | X=36 | X=37 | X=33 | X=35 | X=37 |

38 4006 00100 (number holder for three numbers, including screws for fastening)
38 4006 0000. (numbers)

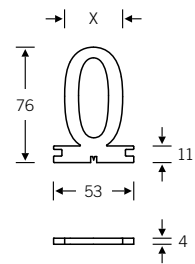
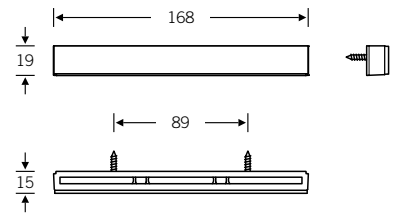

Peephole



38 3898 00000 (peephole for door thickness 35–59 mm)
38 3898 00001 (peephole extension for greater door thicknesses)

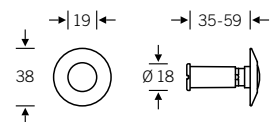

315 **Technical information**
Product collections

Technical information

WC roses

WC sets

FSB WC rose sets are available as sets both with the tried-and-tested FSB AGL® heavy-duty bearing (product group 72) and with the FSB ASL® bearing (product group 12). The FSB AGL® WC variants have a thumb turn (T) on the inside and an emergency release with an indicator (WC) on the outside. The emergency release is incorporated as a slot in the visible square spindle.

Key 34 3464 to the emergency release, which can be used to open the lock from the outside, must be ordered separately. A coin or screwdriver can also be used. The indicator can be omitted if desired.

FSB AGL® WC roses

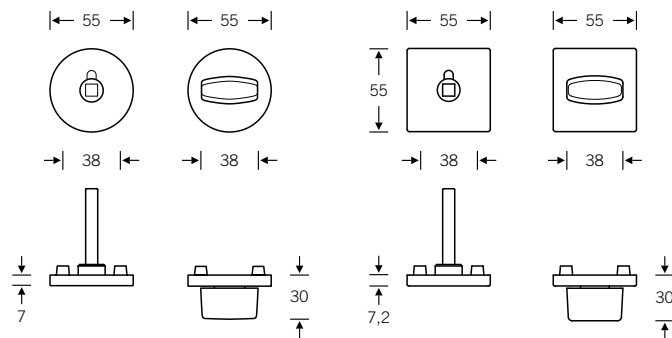

FSB ASL® WC roses

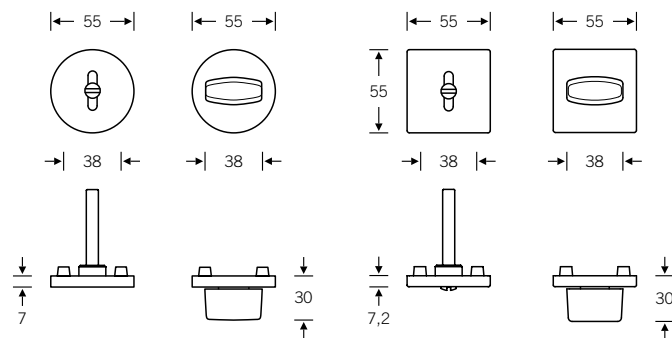

Barrier-free WC bolt

The UN Convention on the Rights of Persons with Disabilities has long been recognised by many countries, for example Germany and Austria. This equality also takes into account the operation of fittings for barrier-free living. To this purpose, the European Committee for Standardization devised the EN 17 210 standard, which stipulates the easy operation of a handle or bolt with the surface of the hand without any rotary movement of the wrist.

The barrier-free WC bolt is fitted on the inside with an extended flat bolt, which is similar to a shortened door handle. The outside red/white indicator is available in the FSB AGL® and FSB ASL® variants.

Barrier-free WC bolt, length 51 mm

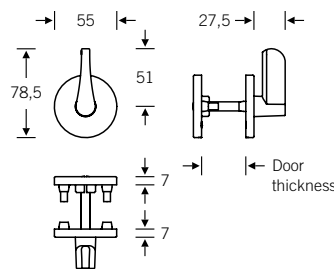

Matching indicator with FSB AGL® or FSB ASL® variant possible; see page 316

Barrier-free WC bolt, length 70 mm

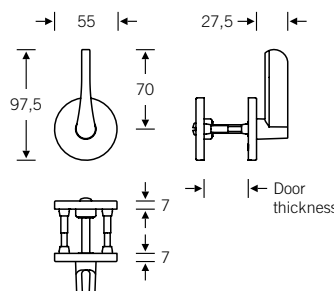

Matching indicator with FSB AGL® or FSB ASL® variant possible; see page 316

This variant is exclusively for the Austrian market.





With FSB, having so much choice has never felt so good. Want angular instead of round roses? Fancy a different door handle design? Need a spare part? The FSB adaptor system opens up a level of flexibility that has never before been known when handling sets or individual parts – and makes for quick installation as well. (Pictured: FSB 1267 door handle)

Photo: Andreas Körner
Project: Penthouse apartment, Stuttgart
Architect: Tina Kammer, InteriorPark.



- 322 FSB kits
- 327 FSB ASL® kit
- 353 FSB roses and backplates kit
- 385 Technical information

Customised product configuration

FSB kits at a glance

The new FSB adaptor system allows you to put together fitting configurations based on the kit-system line. You can order the desired products as a set (complete package) or compile the respective individual parts based on your specific requirements. Keep in mind that some products are not available as a complete set. The following sets and individual components are available:



FSB ASL® kit

Individual parts for configuring an FSB ASL® set

- Rose for lever/lever set
- Rose for WC set
- Rose for lever/knob set
- Short backplate for lever/lever set
- Short backplate for WC set
- Short backplate for lever/knob set
- Long backplate for lever/lever set
- Long backplate for WC set
- Long backplate for lever/knob set



FSB roses and backplates kit

Individual parts

- Cut roses with visible fixing
- Plug-in handles for doors
- Plug-in handles for windows
- Roses for lever handles with privacy function
- Cut backplates with visible fixing
- Short backplates with visible fixing
- Long backplates with visible fixing
- Flush-fitted roses
- Angular/oval window handles
- Lockable angular/oval window handles
- Broad backplate
- Renovation backplate
- Roses and backplates for narrow-stile doors
- Security fittings





For sets, see page 76 ff.

5



Customised product configuration

FSB kits at a glance

The FSB ASL® individual parts and individual roses and backplates shown can be combined with all of the FSB door handle designs on these two pages. Further details can be found starting on page 76 ff.

Door handle models

1001 



1003 



1004 



1005 



1015 



1016 



1021 



1023 



1035 



1045 



1051 



1058 



1070 



1075 



1076 



1078 



1093 



1102 



1106 



1107 



1108 ■ ■



1119 ■ ■ ■



1135 ■



1144 ■ ■



1146 ■ ■



1147 ■ ■



1159 ■ ■



1160 ■ ■



1163 ■ ■ ■



1176 ■ ■



1183 ■ ■



1226 ■



1232 ■



1241 ■



1242 ■ ■ ■



1244 ■ ■



1246 ■



1251 ■ ■



1254 ■



1267 ■ ■ ■



1271 ■ ■



1285 ■



FSB ASL® kit

Overview

Roses

12 1731 | 12 1735 
Page 330



12 1799 | 12 1731 008 
Page 332



12 1703 | 12 1704 
Page 331



12 1799 | 12 1703 008 
Page 332



Backplates

with concealed
fixing

12 1451 
Page 333



12 1418 
Page 334



12 1450 
Page 335



12 1410 
Page 336



Knob backplates

with concealed
fixing

19 1964 | 19 1927 
Page 337



19 1963 | 19 1970 
Page 338



Doorknobs for back-to-back fixing

23 0802 ■ ■ ■
Page 339



23 0803 ■
Page 339



23 0804 ■ ■
Page 340



23 0809 ■ ■ ■
Page 340



23 0811 ■ ■ ■
Page 341



23 0812 ■ ■ ■
Page 341



23 0828 ■ ■
Page 342



23 0829 ■ ■ ■
Page 342



23 0844 ■ ■
Page 343



23 0846 ■ ■ ■
Page 343



23 0854 ■
Page 344



23 0873 ■ ■
Page 344



23 0880 ■ ■
Page 345



Female knob handles

08 0802 ■ ■ ■
Page 346



08 0804 ■ ■
Page 346



08 0829 ■ ■ ■
Page 347



08 0844 ■ ■
Page 347



FSB ASL® kit

Round roses

■ Aluminium
■ Stainless steel
■ Bronze

12 1731 | 12 1735 ■ ■ ■

- 12 1731 001 (handle rose)
- 12 1735 00010 (key rose, PC)
- 12 1735 00002 (key rose, WL)
- 12 1735 00000 (key rose, blank)

12 1735 ■ ■ ■

12 1735 00054 (WC rose)

The unlocking device and indicator are available in the accessory bag, which must be ordered separately.

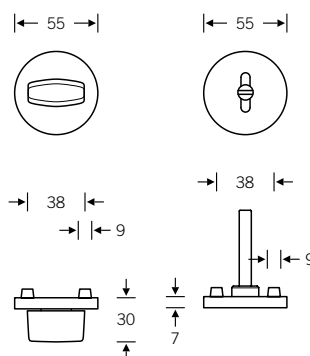
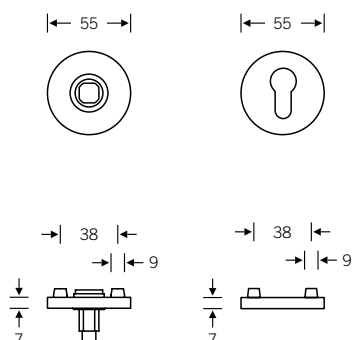

For accompanying accessory bags, see page 348 ff.

FSB ASL® kit

Square roses

■ Aluminium
■ Stainless steel
■ Bronze

12 1703 | 12 1704 ■ ■ ■

- 12 1703 001 (handle rose)
- 12 1704 00010 (key rose, PC)
- 12 1704 00002 (key rose, WL)
- 12 1704 00000 (key rose, blank)

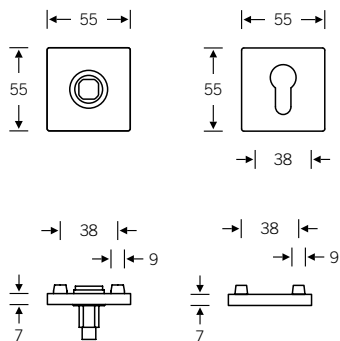

12 1704 ■ ■ ■

12 1704 00054 (WC rose)

The unlocking device and indicator are available in the accessory bag, which must be ordered separately.

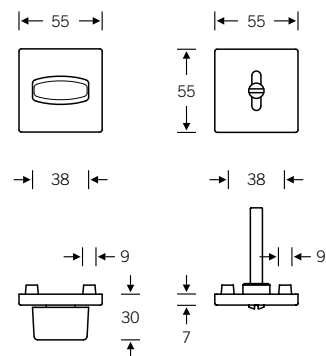

For accompanying accessory bags, see page 348 ff.

FSB ASL® kit

Roses for lever handles with privacy function

■ Aluminium
■ Stainless steel
■ Bronze

12 1799 ■ ■ ■

12 1799 00124
Inside round rose

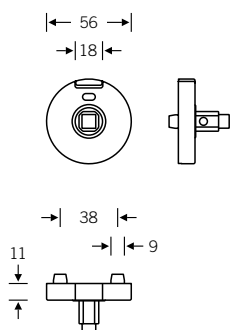

12 1731 ■ ■ ■

12 1731 008
Outside round rose

with emergency release

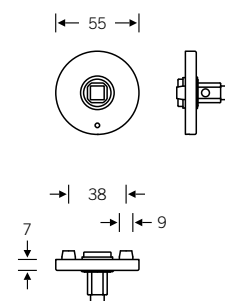

12 1799 ■ ■ ■

12 1799 00125
Inside square rose

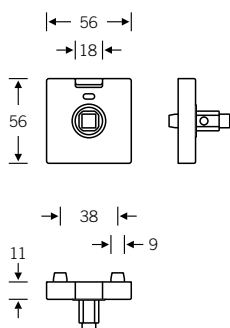

12 1703 ■ ■ ■

12 1703 008
Outside square rose

with emergency release

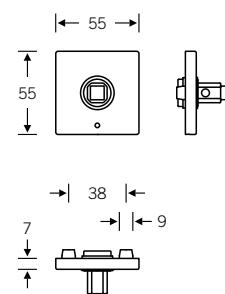

For accompanying accessory bags, see page 348 ff.

FSB ASL® kit

Oval backplates

■ Aluminium
■ Stainless steel
■ Bronze

12 1451 ■ ■ ■

Short oval backplate, PC, WL, WC
(concealed fixing)

C = centres; for possible keyways and centres, see page 387 ff.

The unlocking device and indicator are available in the accessory bag, which must be ordered separately.



5

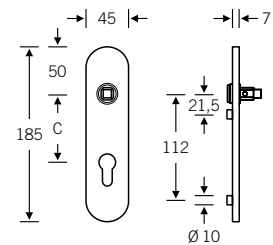

For accompanying accessory bags, see page 348 ff.

Short backplates are not available conforming to ÖNORM (centres PC 88 mm and WL 90 mm)

FSB ASL® kit

Oval backplates

■ Aluminium
■ Stainless steel
■ Bronze

12 1418 ■ ■ ■

Long oval backplate, PC, WL, WC
(concealed fixing)

C = centres; for possible keyways and centres, see page 387 ff.

The unlocking device and indicator are available in the accessory bag, which must be ordered separately.

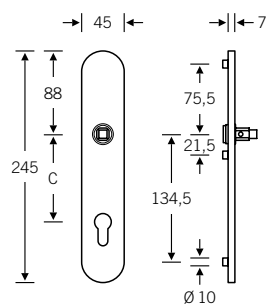

For accompanying accessory bags, see page 348 ff.

FSB ASL® kit

Angular backplates

■ Aluminium
■ Stainless steel
■ Bronze

12 1450 ■ ■ ■

Short angular backplate, PC, WL, WC (concealed fixing)

C = centres; for possible keyways and centres, see page 387 ff.

The unlocking device and indicator are available in the accessory bag, which must be ordered separately.



5

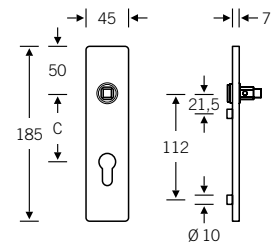

For accompanying accessory bags, see page 348 ff.

Short backplates are not available conforming to ÖNORM (centres PC 88 mm and WL 90 mm)

FSB ASL® kit

Angular backplates

- Aluminium
- Stainless steel
- Bronze

12 1410

Long angular backplate, PC, WL, WC
(concealed fixing)

C = centres; for possible keyways and centres, see page 387 ff.

The unlocking device and indicator are available in the accessory bag, which must be ordered separately.

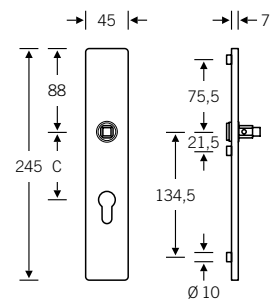

For accompanying accessory bags, see page 348 ff.

FSB ASL® kit

Oval knob backplates

■ Aluminium
■ Stainless steel
■ Bronze

19 1964 ■ ■ ■

19 1964 033
 Short oval knob backplate
 (concealed fixing)

Aluminium X = 77 mm
 Stainless steel X = 73 mm
 Bronze X = 72 mm

C = centres; for possible keyways and centres, see page 387 ff.

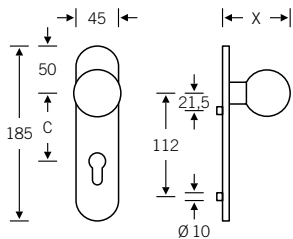

19 1927 ■ ■ ■

19 1927 033
 Long oval knob backplate
 (concealed fixing)

Aluminium X = 77 mm
 Stainless steel X = 73 mm
 Bronze X = 72 mm

C = centres; for possible keyways and centres, see page 387 ff.

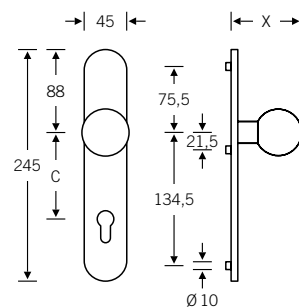

FSB ASL® kit

Angular knob backplates

■ Aluminium
■ Stainless steel
■ Bronze

19 1963 ■ ■ ■

19 1963 033
Short angular knob backplate
(concealed fixing)

Aluminium $\varnothing = 50$ mm
Stainless steel $\varnothing = 55$ mm
Bronze $\varnothing = 50$ mm

C = centres; for possible keyways and centres, see page 387 ff.

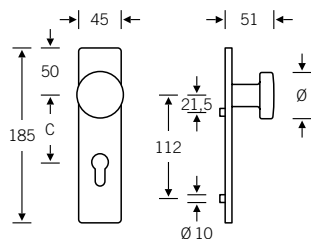

19 1970 ■ ■ ■

19 1970 033
Long angular knob backplate
(concealed fixing)

Aluminium $\varnothing = 50$ mm
Stainless steel $\varnothing = 55$ mm
Bronze $\varnothing = 50$ mm

C = centres; for possible keyways and centres, see page 387 ff.

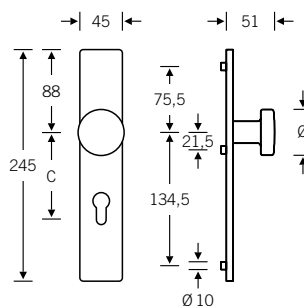

FSB ASL® kit

Doorknobs for back-to-back fixing

- Aluminium
- Stainless steel
- Bronze

23 0802 



23 0802 03400
(through-fixing)

Aluminium X = 77 mm
Stainless steel X = 73 mm
Bronze X = 72 mm

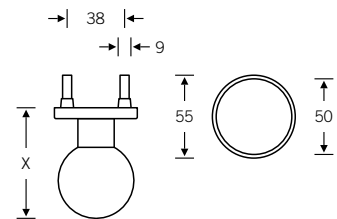

23 0803 



23 0803 03400
(through-fixing)

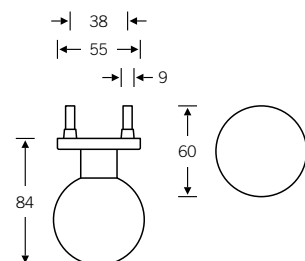

FSB ASL® kit

Doorknobs for back-to-back fixing

■ Aluminium
■ Stainless steel
■ Bronze

23 0804

23 0804 03400
(through-fixing)

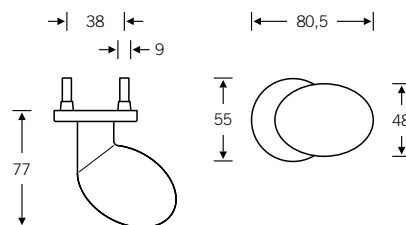

23 0809

23 0809 03400
(through-fixing)

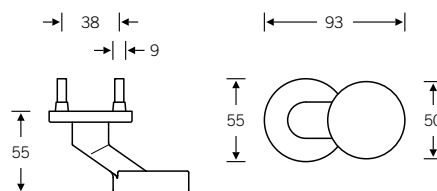

FSB ASL® kit

Doorknobs for back-to-back fixing

- Aluminium
- Stainless steel
- Bronze

23 0811 

23 0811 03500
(through-fixing)

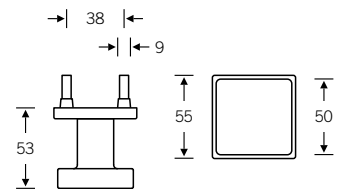

5

23 0812 

23 0812 03500
(through-fixing)

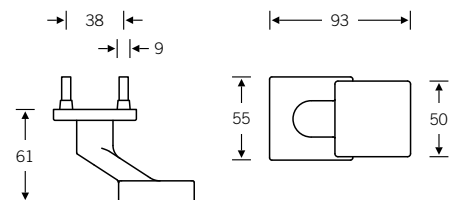

FSB ASL® kit

Doorknobs for back-to-back fixing

■ Aluminium
■ Stainless steel
■ Bronze

23 0828 ■ ■

23 0828 03400
(through-fixing)

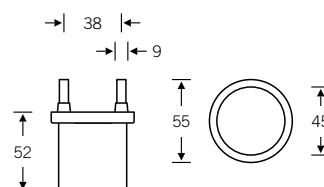

23 0829 ■ ■ ■

23 0829 03400
(through-fixing)

Aluminium $\varnothing = 50$ mm
 Stainless steel $\varnothing = 55$ mm
 Bronze $\varnothing = 50$ mm

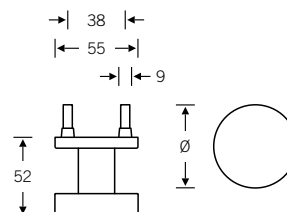

FSB ASL® kit

Doorknobs for back-to-back fixing

- Aluminium
- Stainless steel
- Bronze

23 0844 

Design: Jasper Morrison

23 0844 03400
(through-fixing)

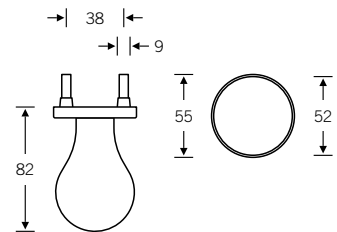

5

23 0846 

23 0846 03400
(through-fixing)

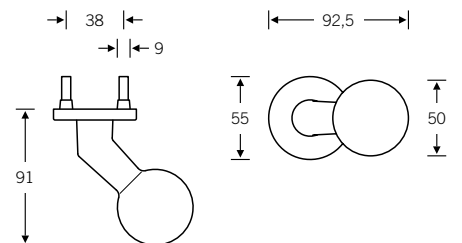

FSB ASL® kit

Doorknobs for back-to-back fixing

- Aluminium
- Stainless steel
- Bronze

23 0854 ■

23 0854 03400
(through-fixing)

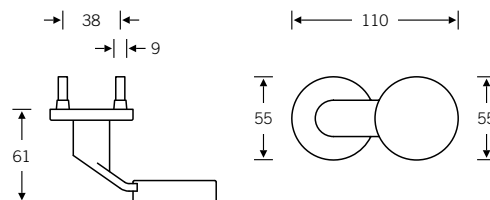

23 0873 ■ ■ ■
Design: Hadi Teherani

23 0873 03500
(through-fixing)

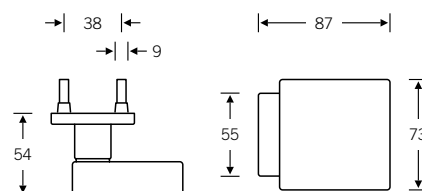

FSB ASL® kit

Doorknobs for back-to-back fixing

- Aluminium
- Stainless steel
- Bronze

23 0880 

Design: Christoph Mäckler

23 0880 03400
(through-fixing)

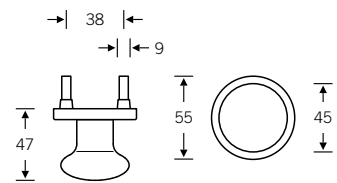

5

FSB ASL® kit

Female knob handles

■ Aluminium
■ Stainless steel
■ Bronze

08 0802 ■ ■ ■

08 0802 04600

Aluminium X = 70 mm
 Stainless steel X = 66 mm
 Bronze X = 65 mm



← 50 →

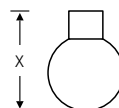

08 0804 ■ ■

08 0804 04600



← 65 →

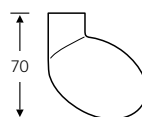

All female knob handles can be combined with FSB rose and backplate components (except FSB AGL®)

FSB ASL® kit

Female knob handles

■ Aluminium
■ Stainless steel
■ Bronze

08 0829 

08 0829 04600

Aluminium $\varnothing = 50$ mm
Stainless steel $\varnothing = 55$ mm
Bronze $\varnothing = 50$ mm

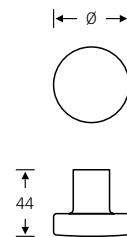

08 0844 

Design: Jasper Morrison

08 0844 04600

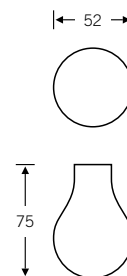

All female knob handles can be combined with FSB rose and backplate components (except FSB AGL®)

FSB ASL® kit

Accessory bags for rose sets

05 0565



05 0565 008 (8 mm rose set)
05 0565 085 (8.5 mm rose set)

Accessory bag
FSB ASL® lever/lever set

05 0566



05 0566 008 (8 mm rose set)
05 0566 085 (8.5 mm rose set)

Accessory bag
FSB ASL® lever/knob set

05 0567



05 0567 008 (8/8 mm rose set)
05 0567 085 (8.5/7 mm rose set)

Accessory bag
FSB ASL® WC set

FSB ASL® kit

Accessory bags for short backplate sets

05 0565



05 0565 108 (8 mm short backplate set)

Accessory bag
FSB ASL® lever/lever set

05 0566



05 0566 108 (8 mm short backplate set)

Accessory bag
FSB ASL® lever/knob set

05 0567



05 0567 108 (8/8 mm short backplate set)

Accessory bag
FSB ASL® WC set

5

FSB ASL® kit

Accessory bags for long backplate sets

05 0565



05 0565 208 (8 mm long backplate set)
05 0565 285 (8.5 mm long backplate set)

Accessory bag
FSB ASL® lever/lever set

05 0566



05 0566 208 (8 mm long backplate set)
05 0566 285 (8.5 mm long backplate set)

Accessory bag
FSB ASL® lever/knob set

05 0567



05 0567 208 (8/8 mm long backplate set)
05 0567 285 (8.5/7 mm long backplate set)

Accessory bag
FSB ASL® WC set

FSB ASL® kit

Accessory bags for lever handles with privacy function

05 0565

05 0565 508 (8 mm)

Accessory bag
Lever handles with privacy function



05 0565

05 0565 585 (8.5 mm)

Accessory bag
Lever handles with privacy function



5

FSB roses and backplates kit

Overview

Backplates

with visible fixing

14 1415 | 14 1418 
Page 358



14 1402 | 14 1410 
Page 359



14 1486 
Page 360





Renovation backplate

14 1433 
Page 361



Cut roses and backplates

17 1790 | 17 1791 
17 1795 | 17 1796 
14 1425 
Page 362 ff.



14 1459 
Page 364



14 1458 
Page 364



Backplates

for narrow-stile doors

14 1550 
Page 366



14 1596 
Page 366



Roses

for narrow-stile doors

09 0001 ■ ■
Page 366



17 1758 ■ ■ ■
17 1788 ■ ■ ■
Page 367



17 1757 ■ ■ ■
17 1778 ■ ■ ■
Page 367



17 1752 ■ ■
Page 367



17 1755 ■ ■
Page 367



Flush-fitted roses

17 1736 | 17 1737 ■ ■
Page 368

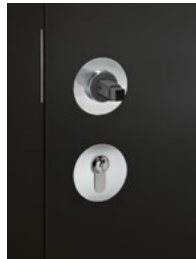

17 1733 | 17 1734 ■ ■
Page 369



Security fittings

Inside backplate,
Lever/lever set

73 3533 ■ ■
Page 373



73 7372 ■
Page 374



FSB roses and backplates kit

Overview

Knob backplates

with visible fixing

19 1923 
Page 370



19 1927 
Page 370



19 1966 
Page 371



19 1970 
Page 371



Roses for plug-in handles

for doors

15 1720 
Page 372



15 1721 
Page 372





15 1721 
Page 372





15 1721 
Page 372



Window-handle roses

34 0000 09030 
34 0000 09039 
Page 381



34 0000 09032 
34 0000 09040 
Page 381



Window-handle roses

lockable

34 0000 170 
Page 382



34 0000 180 
Page 382



34 0000 076 
Page 382



34 0000 086 
Page 382



Roses for plug-in handles

for windows

34 0000 71101 ■ ■ ■
 34 0000 75101
 Page 383



03 0401 00003
 Page 383



Doorknobs

with face fixing

23 0802 ■ ■ ■
 Page 375



23 0803 ■
 Page 375



23 0804 ■ ■
 Page 376



23 0811 ■ ■ ■
 Page 376



23 0828 ■ ■
 Page 377



23 0829 ■ ■ ■
 Page 377



23 0844 ■ ■
 Page 378



23 0880 ■ ■
 Page 378



Female knob handles

08 0802 ■ ■ ■
 Page 379



08 0804 ■ ■
 Page 379



08 0829 ■ ■ ■
 Page 380





08 0844 ■ ■
 Page 380



FSB roses and backplates kit

Oval backplates



- Aluminium
- Stainless steel
- Bronze

14 1415  

14 1415 100
(visible fixing)

C = centres; for possible keyways and centres, see page 387 ff.



14 1418  

14 1418 100
(visible fixing)

C = centres; for possible keyways and centres, see page 387 ff.

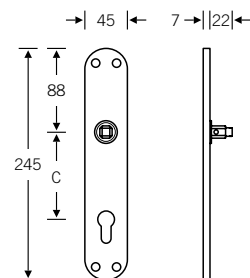
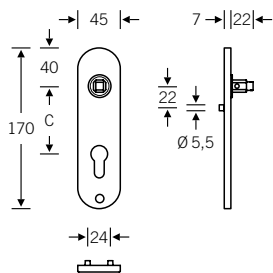

FSB roses and backplates kit

Angular backplates

- Aluminium
- Stainless steel
- Bronze

14 1402

14 1402 100
(visible fixing)

C = centres; for possible keyways and centres, see page 387 ff.



14 1410

14 1410 100
(visible fixing)

C = centres; for possible keyways and centres, see page 387 ff.

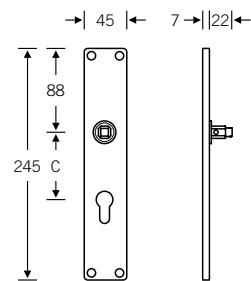
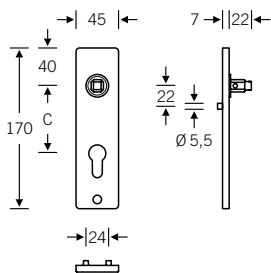

FSB roses and backplates kit

Broad backplate

■ Aluminium
■ Stainless steel
■ Bronze

14 1486 ■

14 1486 101
(visible fixing)

Stainless steel X = 2 mm
Corner radius 4 mm

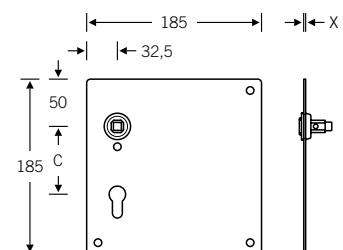

C = centres; for possible keyways
and centres, see page 387 ff.



FSB roses and backplates kit

Renovation backplate

■ Aluminium
■ Stainless steel
■ Bronze

14 1433  



14 1433 103
(concealed fixing)

C = centres; for possible keyways and centres, see page 387 ff.

The FSB 14 1433 backplate was developed specifically with renovation jobs in mind; at 55 mm wide, it provides an ideal means of concealing traces of the hardware replaced.

Invisibly fixed to the door, this gently vaulted backplate combines with its black base to create an impression of floating.

5

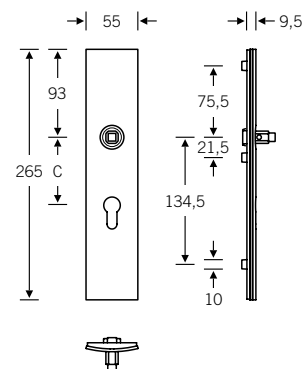

FSB roses and backplates kit

Cut roses

- Aluminium
- Stainless steel
- Bronze

17 1790 | 17 1795 ■
 17 1791 | 17 1796 ■



Handle roses

- 17 1790 101 (round, visible fixing on both sides)
- 17 1790 102 (round, concealed fixing on one side)
- 17 1795 101 (square, visible fixing on both sides)
- 17 1795 102 (square, concealed fixing on one side)

Key roses

- 17 1791 001 (round, visible fixing on both sides)
- 17 1791 002 (round, concealed fixing on one side)
- 17 1796 001 (square, visible fixing on both sides)
- 17 1796 002 (square, concealed fixing on one side)

Material thickness 3 mm

Stabiliser lugs in stainless steel

Screw centres 38 mm

Corner radius 2 mm

Square spindle 8 mm

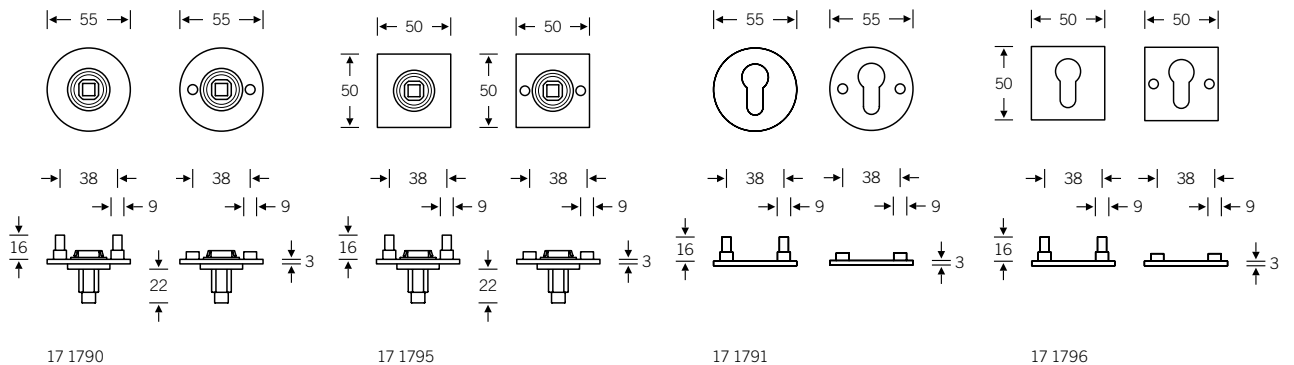

FSB roses and backplates kit

Cut backplate

■ Aluminium
■ Stainless steel
■ Bronze

14 1425 ■ ■

14 1425 100 (visible fixing on both sides)
14 1425 175 (WC, visible fixing on both sides)

Material thickness 3 mm

Screw centres 38 mm

C = centres; for possible keyways and centres, see page 387 ff.



5

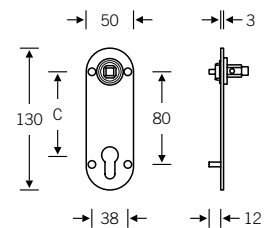

Short backplates are not available conforming to ÖNORM (centres PC 88 mm and WL 90 mm)

FSB roses and backplates kit

Cut backplates

- Aluminium
- Stainless steel
- Bronze

14 1459 ■

- 14 1459 101 (visible fixing on both sides)
- 14 1459 102 (concealed fixing on one side)
- 14 1459 13154 (WC, visible fixing on both sides)
- 14 1459 13254 (WC, concealed fixing on one side)

C = centres; for possible keyways and centres, see page 387 ff.

14 1458 ■

- 14 1458 101 (visible fixing on both sides)
- 14 1458 102 (concealed fixing on one side)
- 14 1458 13154 (WC, visible fixing on both sides)
- 14 1458 13254 (WC, concealed fixing on one side)

C = centres; for possible keyways and centres, see page 387 ff.

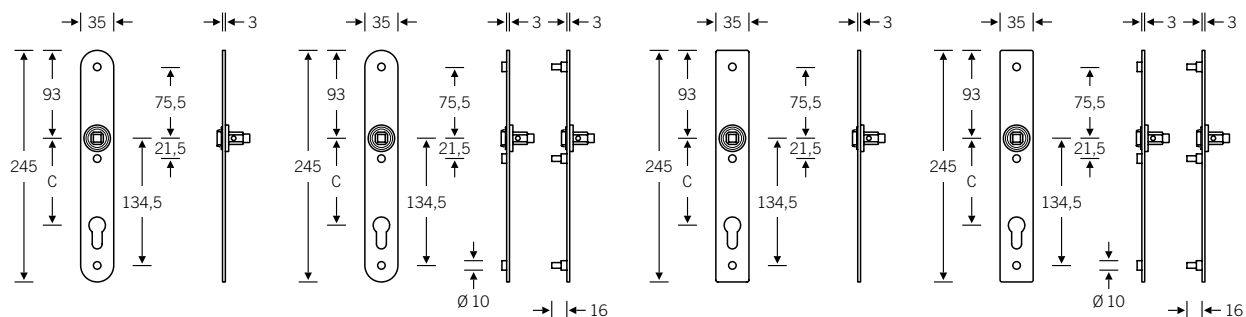

FSB roses and backplates kit

Order form for cut backplates

- Aluminium
- Stainless steel
- Bronze

14 1458 | 14 1459

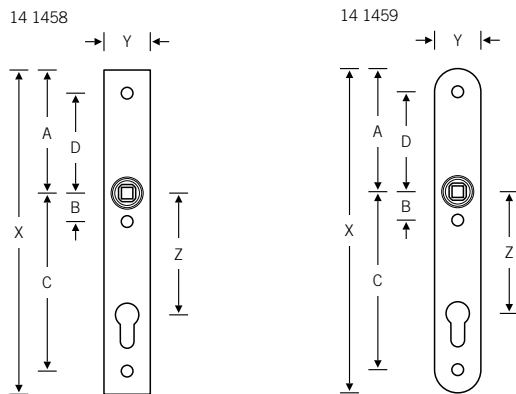

Order form for cut backplates made to order with stainless steel stabiliser lugs (please configure in the table using the adjacent illustrations)

Angular variant:

14 1458 (angular, 35 × 245 mm)

Round variant:

14 1459 (round, 35 × 245 mm)

5

| | 14 1458 | 14 1459 |
|---------------------|--------------------------------------------------------------------------|--------------------------------------------------------------------------|
| Backplate thickness | 3 mm | 3 mm |
| Door thickness | | |
| Length X | | |
| Width Y | | |
| Dimension A | | |
| Dimension B | | |
| Dimension C | | |
| Dimension D | | |
| Centres Z | | |
| Keyway | | |
| Fixing (visibility) | <input type="checkbox"/> one side <input type="checkbox"/> both sides | <input type="checkbox"/> one side <input type="checkbox"/> both sides |

FSB roses and backplates kit

Backplates and roses for narrow-stile doors

- Aluminium
- Stainless steel
- Bronze

14 1550 | 14 1596



14 1550 110
(angular backplate, visible fixing)
Square spindle 8 mm, without positive mechanism, screw centres 210 mm, suitable for M4 countersunk screws

Due to its slender styling, FSB 14 1550 can be combined with locks with a small backset, and is thus a compelling proposition for narrow stiles, both aesthetically and functionally.

14 1596 101
(oval backplate, concealed fixing)
Square spindle 8 mm, without positive mechanism

C = centres; for possible keyways and centres, see page 387 ff.

09 0001

09 0001 11143 (oval)
09 0001 17143 (angular)
Square spindle 8 mm, with positive mechanism, non-handed

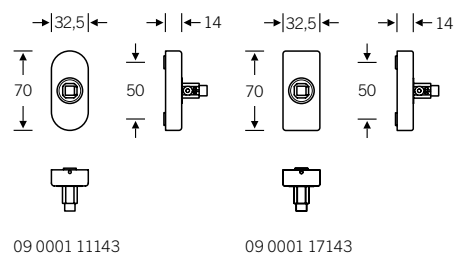
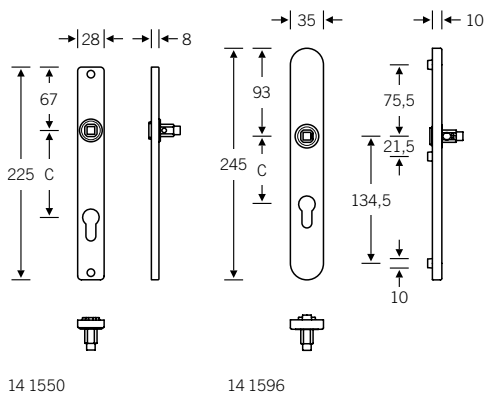

For fixing accessories 09 0001, see page 767

FSB roses and backplates kit

Roses for narrow-stile doors

- Aluminium
- Stainless steel
- Bronze

17 1758 | 17 1788

17 1758 100 (oval)
 17 1788 100 (angular)
 Square spindle 8 mm, without positive mechanism

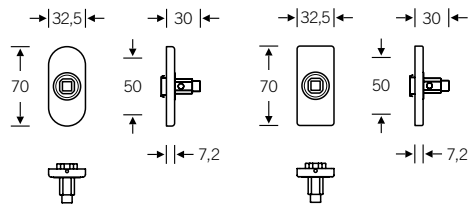

17 1758

17 1788

17 1757 | 17 1778

17 1757 000 (oval)
 17 1778 000 (angular)

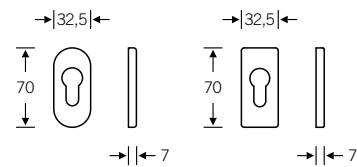

17 1757

17 1778

17 1752

17 1752 110
 Square spindle 8 mm, without positive mechanism

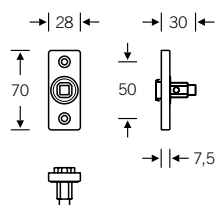

17 1755

17 1755 010

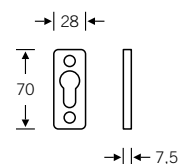

For fixing accessories, see page 767

Screw centres 50 mm,
 suitable for M5 countersunk screws

FSB roses and backplates kit

Round, flush-fitted roses

■ Aluminium
■ Stainless steel
■ Bronze



17 1736 ■ ■

17 1737 ■ ■

17 1736 10001 (handle rose)
 Square spindle 8 mm
 17 1736 30001 (handle rose)
 Square spindle 8 mm, with sleeve
 8/8.5 mm
 17 1737 00... (key rose)

Keyways:

..002 (WL)
 ..010 (PC)
 ..154 (T/WC 8 mm)
 ..188 (T/WC 7 mm)

Suitable for standard door thicknesses of 38–42 mm; available up to door thickness 67 mm

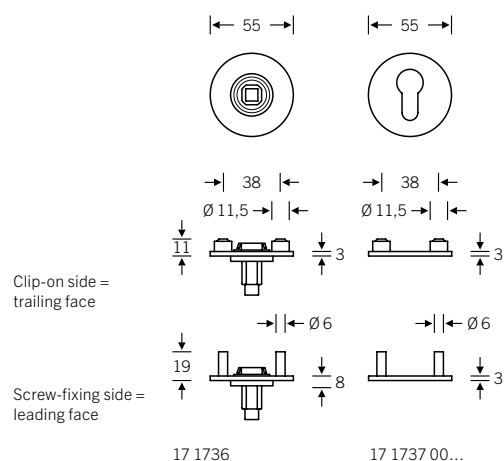

Specification:

Pairs of loose, round handle and key roses for flush-fitted installation; female handles and rose pairs removable; not available as fire safety variant

Suitable drilling template:

FSB 03 0455 or universal template
 FSB 03 0460; see page 775 ff.

Suitable routing jig:

FSB 03 0462 000..; see page 782

Order details required:

- Door handle model*; see page 324 f.
- Keyway
- Material/finish
- Quantity
- DIN door handing for rebated doors in combination with asymmetrical lever handles
- Door thickness

* The following models are not available as a flush-fitted variant with rose 17 1736: FSB 1051, 1058, 1163, 1241, 1251, 1254, 1285

For technical information, see page 390 f.

Specify the exact door thickness when ordering (the standard door thickness increment is 38–42 mm).

FSB roses and backplates kit

Square, flush-fitted roses

■ Aluminium
■ Stainless steel
■ Bronze



17 1733 ■ ■

17 1734 ■ ■

17 1733 10001 (handle rose)
 Square spindle 8 mm
 17 1733 30001 (handle rose)
 Square spindle 8 mm, with sleeve
 8/8.5 mm
 17 1734 00... (key rose)

Keyways:

..002 (WL)
 ..010 (PC)
 ..154 (T/WC 8 mm)

Suitable for standard door thicknesses of 38–42 mm; available up to door thickness 67 mm

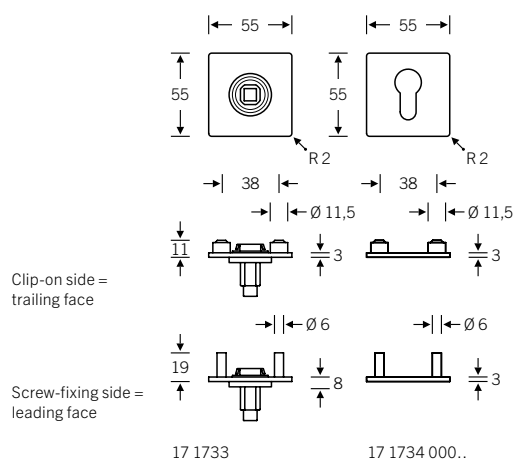

17 1733

17 1734 000..

Specification:

Pairs of loose, square handle and key roses for flush-fitted installation; female handles and rose pairs removable; not available as fire safety variant

Suitable drilling template:

FSB 03 0455 or universal template
 FSB 03 0460; see page 775 ff.

Suitable routing jig:

FSB 03 0462 000..; see page 782

Order details required:

- Door handle model*; see page 324 f.
- Keyway
- Material/finish
- Quantity
- DIN door handing for rebated doors in combination with asymmetrical lever handles
- Door thickness

* The following models are not available as a flush-fitted variant with rose 17 1733: FSB 1051, 1058, 1163, 1241, 1251, 1254, 1285

For technical information, see page 390 f.

Specify the exact door thickness when ordering (the standard door thickness increment is 38–42 mm).

FSB roses and backplates kit

Knob backplates with visible fixing

■ Aluminium
■ Stainless steel
■ Bronze

19 1923 ■ ■

19 1923 000

Visible fixing; can only be combined with backplates with visible fixing; see page 358 f.

Aluminium X = 77 mm
Stainless steel X = 73 mm

C = centres; for possible keyways and centres, see page 387 ff.

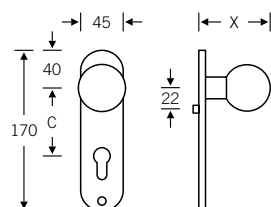

19 1927 ■ ■

19 1927 000

Visible fixing; can only be combined with backplates with visible fixing; see page 358 f.

Aluminium X = 77 mm
Stainless steel X = 73 mm

C = centres; for possible keyways and centres, see page 387 ff.

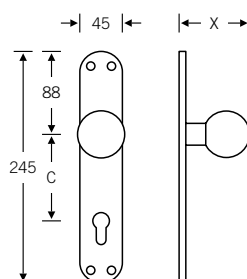

For drilling templates, see page 776

FSB roses and backplates kit

Knob backplates with visible fixing

■ Aluminium
■ Stainless steel
■ Bronze

19 1966 ■ ■

19 1966 000

Visible fixing; can only be combined with backplates with visible fixing; see page 358 f.

Aluminium $\varnothing = 50$ mm
 Stainless steel $\varnothing = 55$ mm

C = centres; for possible keyways and centres, see page 387 ff.

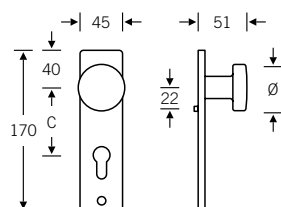

19 1970 ■ ■

19 1970 000

Visible fixing; can only be combined with backplates with visible fixing; see page 358 f.

Aluminium $\varnothing = 50$ mm
 Stainless steel $\varnothing = 55$ mm

C = centres; for possible keyways and centres, see page 387 ff.

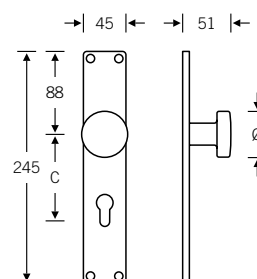

For drilling templates, see page 776

FSB roses and backplates kit

Roses for plug-in handles for doors

- Aluminium
- Stainless steel
- Bronze

15 1720

15 1720 08001 (square spindle 8 mm)
 15 1720 08501 (square spindle 8.5 mm)
 Handle rose

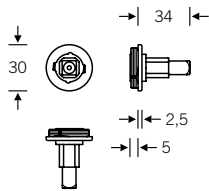

15 1721

15 1721 00002 (WL)
 15 1721 00004 (WL, 90 mm)
 Adhesive rose

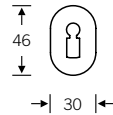

15 1721

15 1721 00010 (PC)
 Adhesive rose

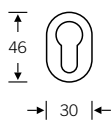

15 1721

15 1721 01054 (WC 78, 8/8 mm)
 15 1721 01088 (WC 90, 8.5/7 mm)
 Adhesive rose

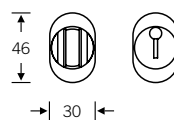

FSB roses and backplates kit

Oval inside backplate for security fitting

■ Aluminium
■ Stainless steel
■ Bronze

73 3533 ■ ■

73 3533 00310 (PC 72)
73 3533 00312 (PC 92)

Inside backplate for FSB security fitting,
square spindle 8 mm

Cannot be combined with security fittings
in fire safety variant 73 75.. (can only be
ordered as a complete set)

All oval inside backplates for FSB security
fittings with 8 mm square spindles are
equipped with the adaptor system and can
be ordered separately as individual parts.
Angular inside backplates and sets with
9 mm square spindles can only be ordered
as complete sets. Further information can
be found starting on page 712 ff.

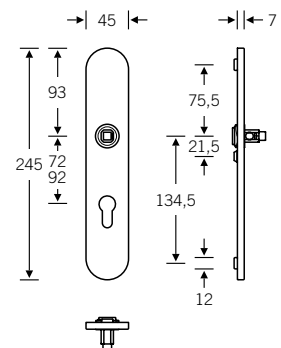

FSB roses and backplates kit

Security fitting

■ Aluminium
■ Stainless steel
■ Bronze

73 7372 ■



Lever/lever set
 Security grade 3 pursuant to EN 1906,
 suitable for RC3 doors, with cylinder guard
 (ZA) 8–12 mm

For door thicknesses 38–102 mm
 (standard door thickness 38–42 mm)

C = centres; for possible keyways and
 centres, see page 387 ff.

The lever handle model can be freely
 selected and must be ordered separately;
 for possible designs, see page 324 ff.

Materials:

Outside backplate available in Stainless
 Steel 6204;
 inside backplate available in Stainless
 Steel 6204,
 Aluminium 0105 and Aluminium 0810

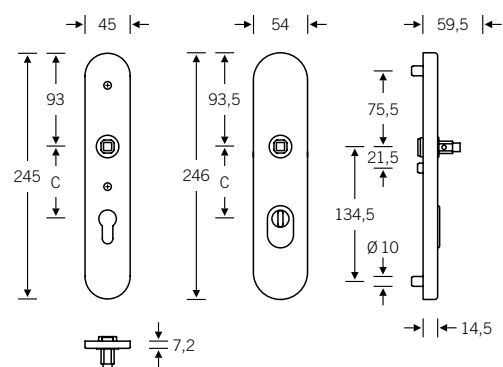

EN 1906
 ÖNORM B3859
 SKG

FSB roses and backplates kit

Doorknobs

■ Aluminium
■ Stainless steel
■ Bronze

23 0802 ■ ■ ■

23 0802 00005
(face fixing)

Aluminium X = 77 mm
Stainless steel X = 73 mm
Bronze X = 72 mm

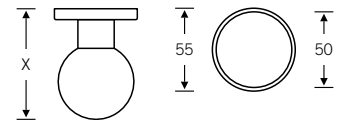

5

23 0803 ■

23 0803 00005
(face fixing)

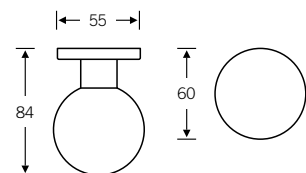

FSB roses and backplates kit

Doorknobs

- Aluminium
- Stainless steel
- Bronze

23 0804 

23 0804 00005
(face fixing)

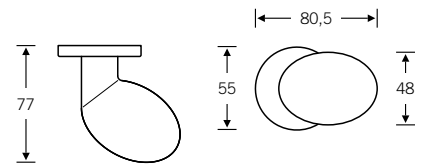

23 0811 

23 0811 00025
(face fixing)

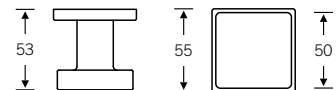

FSB roses and backplates kit

Doorknobs

■ Aluminium
■ Stainless steel
■ Bronze

23 0828 

23 0828 00005
(face fixing)

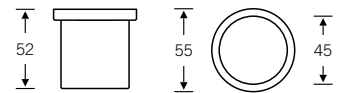

5

23 0829 

23 0829 00005
(face fixing)

Aluminium $\varnothing = 50$ mm
Stainless steel $\varnothing = 55$ mm
Bronze $\varnothing = 50$ mm

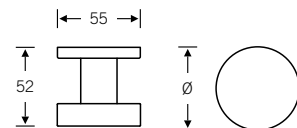

FSB roses and backplates kit

Doorknobs

- Aluminium
- Stainless steel
- Bronze

23 0844 

Design: Jasper Morrison

23 0844 00005

(face fixing)

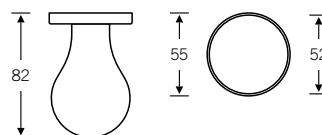

23 0880 

Design: Christoph Mäckler

23 0880 00035

(face fixing)

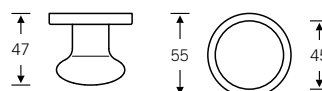

FSB roses and backplates kit

Female knob handles

■ Aluminium
■ Stainless steel
■ Bronze

08 0802 

08 0802 04600

Aluminium X = 70 mm
Stainless steel X = 66 mm
Bronze X = 65 mm

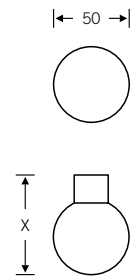

08 0804 

08 0804 04600

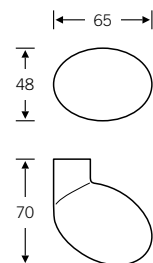

All female knob handles can be combined with FSB rose and backplate components (except FSB AGL®)

FSB roses and backplates kit

Female knob handles

■ Aluminium
■ Stainless steel
■ Bronze

08 0829



08 0829 04600

Aluminium $\varnothing = 50$ mm
Stainless steel $\varnothing = 55$ mm
Bronze $\varnothing = 50$ mm

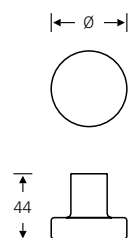

08 0844

Design: Jasper Morrison



08 0844 04600

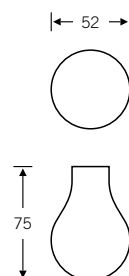

All female knob handles can be combined with FSB rose and backplate components (except FSB AGL®)

FSB roses and backplates kit

Window-handle roses

- Aluminium
- Stainless steel
- Bronze

34 0000

34 0000 09030 (oval rose 62 × 27 mm)
34 0000 09039 (oval rose 70 × 32.5 mm)

Window-handle rose with click-stop mechanism
conforming to EN 13126-3

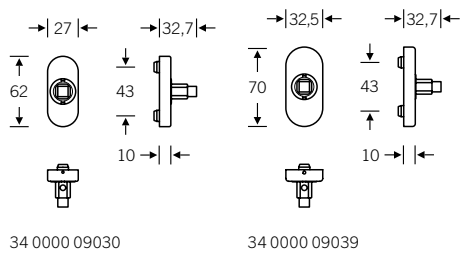

34 0000

34 0000 09032 (angular rose 62 × 27 mm)
34 0000 09040 (angular rose 70 × 32.5 mm)

Window-handle rose with click-stop mechanism
conforming to EN 13126-3

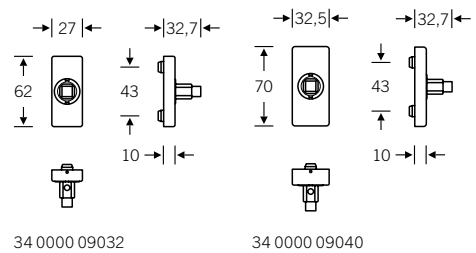

including 7 mm spindle, projection
24 – 38 mm

FSB roses and backplates kit

Lockable window-handle roses

■ Aluminium
■ Stainless steel
■ Bronze

34 0000 ■ ■ ■

34 0000 170 (oval with lock cylinder)
 34 0000 180 (angular with lock cylinder)

Lockable window-handle rose,
with lock cylinder

conforming to EN 13126-3

Lock cylinder can also be fitted pointing down

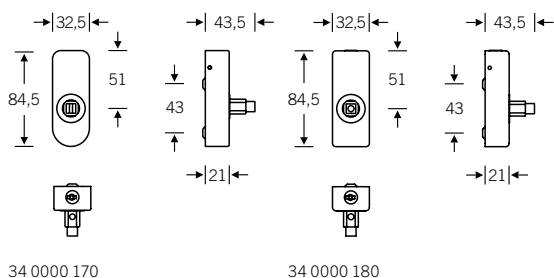

34 0000 ■ ■ ■

34 0000 076 (oval with push-button)
 34 0000 086 (angular with push-button)

Lockable window-handle rose,
with push-button

conforming to EN 13126-3

Push-button can also be fitted pointing down

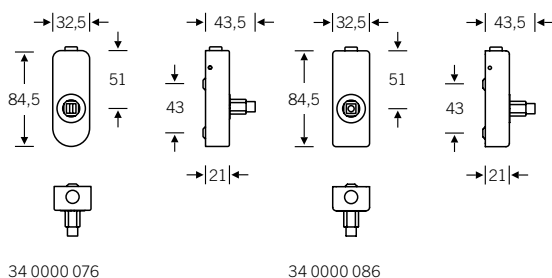

Suitable accessories for 34 mm spindle projection included in scope of delivery; other spindle projections possible

FSB roses and backplates kit

Roses for plug-in handles for windows

■ Aluminium
■ Stainless steel
■ Bronze

34 0000 ■ ■ ■

Round rose for non-lockable plug-in handles

... 71101
 (for metal and timber windows; in the case of timber windows, fixing roses must be ordered separately – see next product)

... 75101
 (for PVC windows)

with click-stop mechanism, conforming to EN 13126-3

03 0401

03 0401 00003 0400

Fixing rose and mounting plate for timber profiles

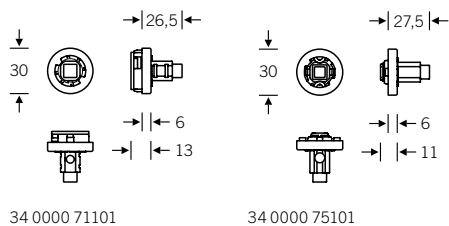

including 7 mm spindle, projection 24–38 mm

385 **Technical information**

Customised product configuration

Technical information

Roses and backplates

FSB ASL® kit

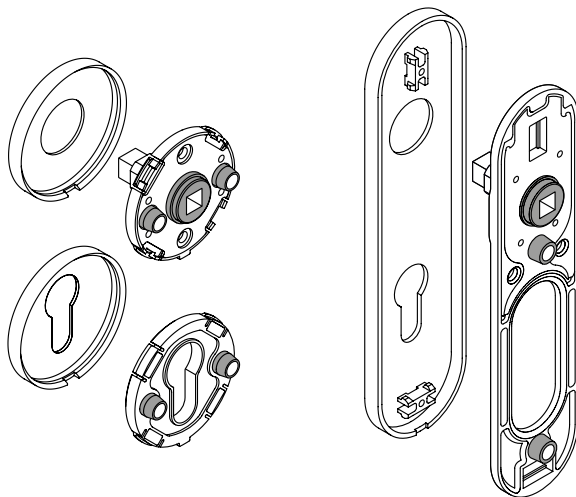

Roses with concealed fixing

The metal cover roses fit over bases made partly of metal, partly of plastic, with two stabiliser lugs (diameter 9 mm, length 6 mm) in the attachment area; screw centres 38 mm.

Short and long backplates with concealed fixing

Short and long backplates with concealed fixing operate with bases design-engineered in the same manner as those for roses, but with a stabiliser lug diameter of 10 mm and length of 5.5 mm. FSB door hardware should always be fitted in conjunction with its companion FSB accessories. Further information about the FSB bearings can be found on page 52 ff.

FSB roses and backplates

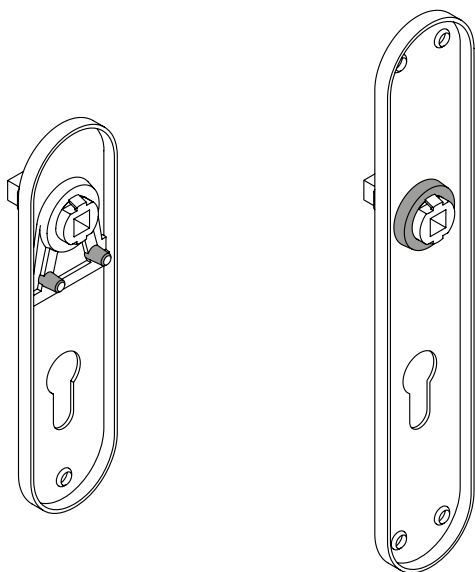

Backplates with visible fixing

Apart from a visible screw with which to secure the backplate, standard short backplates with visible fixing have two stabiliser lugs beneath the handle bushing that prevent lateral displacement on the surface of the door. Standard long backplates are fixed to the door with four visible screws. The screw holes are suitable for 3.9 mm countersunk screws.

Technical information

Roses and backplates

Centres (c:c distances)

The standard c:c distance for room-door backplates is 72 mm (WL and PC), for bathroom-door backplates 78 mm and for entrance-door backplates 92 mm (WL and PC). The distances are measured as follows:

1. Warded lock and Chubb
Centre of follower to centre of key pin
2. Profile cylinder
Centre of follower to centre of cylinder plug
3. Oval cylinder
Centre of follower to centre of oval cylinder
4. Round cylinder
Centre of follower to centre of round cylinder
5. Emergency release
Centre of follower to centre of emergency release
6. WC
Centre of follower to centre of emergency release with indicator
7. Thumb turn
Centre of follower to centre of thumb turn

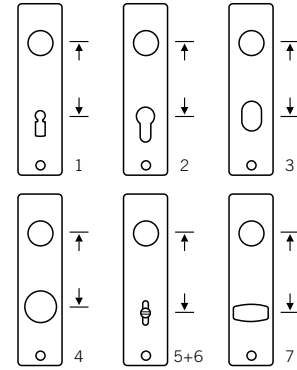

Keyways

Unless otherwise specified, we supply backplates and rosettes with warded lock (WL) keyways.

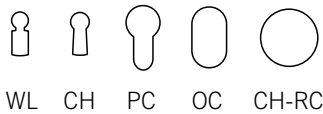

WL CH PC OC CH-RC

Technical information

Backplates

| Backplate | Keyway/ centres | Square spindle | Backplate | Keyway/ centres | Square spindle |
|------------------------------------------|--------------------|----------------|--------------------|--------------------|----------------|
| 12 1451 | PC 55 | 8 mm | 14 1402 14 1415 | PC 55 | 8 mm |
| | PC 70 | 7 mm | | PC 70 | 7 mm |
| | PC 72 | 8 mm | | PC 72 | 8 mm |
| | WL 72 | 8 mm | | WL 72 | 8 mm |
| | WC 63 | 8/8 mm | | WL 78 | 8 mm |
| | WC 72 | 8/8 mm | | WC 63 | 8/8 mm |
| | WC 78 | 8/8 mm | | WC 70 | 7/6 mm |
| | CH 56 | 8 mm | | WC 72 | 8/8 mm |
| 12 1410 12 1418 14 1458 14 1459 | PC 55 | 8 mm | 14 1410 14 1418 | WC 78 | 8/8 mm |
| | PC 72 | 8 mm | | CH-RC 78 | 8 mm |
| | PC 88 | 8.5 mm | | PC 72 | 8 mm |
| | PC 92 | 8 mm | | PC 88 | 8.5 mm |
| | WL 72 | 8 mm | | PC 92 | 8 mm |
| | WL 90 | 8.5 mm | | WL 72 | 8 mm |
| | WC 63 | 8/8 mm | | WL 78 | 8 mm |
| | WC 70 | 7/6 mm | | WL 90 | 8.5 mm |
| | WC 72 | 8/8 mm | | WL 92 | 8 mm |
| | WC 78 | 8/8 mm | | WC 78 | 8/8 mm |
| | WC 90 | 8.5/7 mm | | WC 90 | 8.5/7 mm |
| | CH 56 | 8 mm | | CH-RC 74 | 8 mm |
| CH 70 | 7 mm | CH-RC 78 | 8 mm | | |
| 12 1450 | PC 55 | 8 mm | 14 1486 | PC 72 | 8 mm |
| | PC 72 | 8 mm | | PC 88 | 8.5 mm |
| | WL 72 | 8 mm | | WC 78 | 8/8 mm |
| | WC 63 | 8/8 mm | | | |
| | WC 72 | 8/8 mm | | | |
| | WC 78 | 8/8 mm | | | |

Technical information

Backplates

| Backplate | Keyway/ centres | Square spindle | Knob backplate | Keyway/ centres |
|-----------|--------------------|----------------|------------------------------------------------------------------|--------------------|
| 14 1433 | PC 72 | 8 mm | 19 1923 | PC 55 |
| | PC 88 | 8.5 mm | | PC 72 |
| | PC 92 | 8 mm | | WL 72 |
| | WL 72 | 8 mm | 19 1927 000 visible fixing 19 1927 033 concealed fixing | PC 72 |
| | WC 78 | 8/8 mm | | PC 88 |
| | WC 90 | 8.5/7 mm | | PC 92 |
| 14 1425 | PC 70 | 7 mm | 19 1963 19 1964 | PC 72 |
| | PC 72 | 8 mm | | |
| | WL 72 | 8 mm | 19 1966 | PC 55 |
| | WC 70 | 7/6 mm | | PC 72 |
| | WC 78 | 8/8 mm | | CH 56 |
| 14 1550 | PC 70 | 7 mm | 19 1970 000 visible fixing | PC 55 |
| | PC 72 | 8 mm | | PC 72 |
| | PC 78 | 8 mm | | PC 88 |
| | PC 88 | 8.5 mm | | PC 92 |
| | PC 92 | 8 mm | | CH-RC 74 |
| | WL 72 | 8 mm | 19 1970 033 concealed fixing | PC 72 |
| | CH-RC 78 | 8 mm | | PC 88 |
| | CH-RC 94 | 8 mm | | PC 92 |
| 14 1596 | PC 72 | 8 mm | | |
| | PC 88 | 8.5 mm | | |
| | PC 92 | 8 mm | | |
| 73 7372 | PC 55 | 8 mm | | |
| | PC 70 | 7 mm | | |
| | PC 72 | 8 mm | | |
| | PC 85 | 8 mm | | |
| | PC 88 | 8/8.5 mm | | |

Technical information

WC roses

FSB ASL® WC roses

FSB WC rose sets are available with the FSB ASL® bearing both as a set and also as individual parts. Find your desired door handle model and the associated product code on page 76 ff. The unlocking device and indicator are supplied in the accompanying accessory bag (see page 348 ff.).

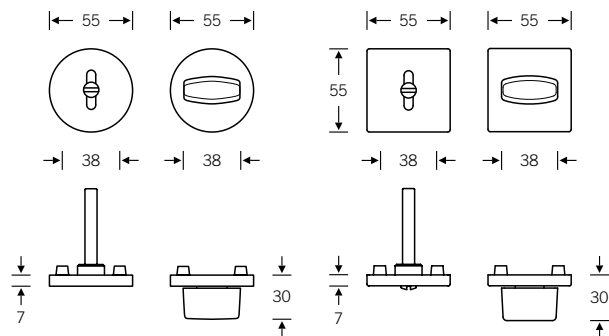

Flush-fitted WC roses 17 1734 and 17 1737

Flush-fitted FSB WC roses are available as individual parts in the round and square variant. Find your desired door handle model and the associated product code on page 76 ff.

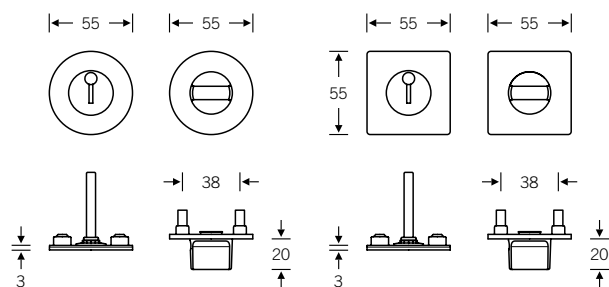

Round WC roses:

- 17 1737 00154 (T/WC 8 mm)
- 17 1737 00188 (T/WC 7 mm)

Square WC roses:

- 17 1734 00154 (T/WC 8 mm)

WC variants

for backplates and roses:

- 12 1735, 12 1704, 12 1451, 12 1418,
- 12 1410, 12 1450, 14 1415, 14 1402,
- 14 1418, 14 1410, 14 1486, 14 1433



I WC T

for backplates and roses:

- 14 1458, 14 1459, 17 1734,
- 17 1737, 17 1796, 17 1791



WC T

Technical information

Flush-fitted roses

Round, flush-fitted roses

We provide CAD data for CNC routing. You can find these online in our digital catalogue.

Technical prerequisites: the door must be at least 38 mm and no more than 67 mm thick; bear in mind the position of the lock mortise as well.

Drilling: use FSB drilling template 03 0455 or universal template 03 0460 on both sides. Then drill the holes for the handle and key roses on the clip-on side to a depth and diameter of 12 mm.

(For drilling template, see page 775 ff.)

Routing: use routing jig FSB 03 0462 000.. when preparing the face of the door for the roses to be fitted. Please note that, unlike with flush-fitted FSB AGL® sets for door thicknesses of 45 mm upwards, routing may only be performed to a depth of 3 mm!

The recess routed out for the round variant (17 1736 / 17 1737) needs to be 55.6 mm in diameter and 3 mm deep. The remaining material between the bottom of the recess and the lock case must be stable and firm enough to ensure secure fastening without any pressure being exerted upon the lock.

(For routing jig, see page 782)

Specification: pairs of loose, round handle and key roses for flush-fitted installation; female handles and rose pairs removable. Not available as fire safety variant.

Square, flush-fitted roses

We provide CAD data for CNC routing. You can find these online in our digital catalogue.

Technical prerequisites: the door must be at least 38 mm and no more than 67 mm thick; bear in mind the position of the lock mortise as well.

Drilling: use FSB drilling template 03 0455 or 03 0460 on both sides. Then drill the holes for the handle and key roses on the clip-on side to a depth and diameter of 12 mm.

(For drilling template, see page 775 ff.)

Routing: use routing jig FSB 03 0462 00030 when preparing the face of the door for the roses to be fitted. Please note that, unlike with flush-fitted FSB AGL® sets for door thicknesses of 45 mm upwards, routing may only be performed to a depth of 3 mm! The recess routed out for the square variant (17 1733 / 17 1734) measures 55.6 × 55.6 mm and has a corner radius of 2 mm. Please use a Ø 4 mm routing bit to route the corners.

The specified radius of 2 mm is then automatically achieved using routing jig 03 0462 00030. The remaining material between the bottom of the recess and the lock case must be stable and firm enough to ensure secure fastening without any pressure being exerted upon the lock.

(For routing jig, see page 782)

Specification: pairs of loose, square handle and key roses for flush-fitted installation; female handles and rose pairs removable. Not available as fire safety variant.

Keyways and bathroom/WC variants

(Please request other keyways and centres individually)



WL PC WC T



- 394 Plug-in handles for doors
- 406 Fittings for windows
- 462 Fittings for narrow-stile doors
- 496 Fittings for glass doors
- 526 Lever handles with privacy function
- 534 Flush-fitted hardware

Whether you need a plug-in handle with minimalist rose, an in-line or cranked narrow-stile door handle, a lockable window handle or flush-fitted hardware with a recessed rose, with the FSB range you really do have everything within your grasp. The sheer number of different variants and designs ensures that every desired ambiance and every functional requirement find the optimal solution. (Pictured: FSB 1244 lever handle with privacy function)

Project: Family home, Gütersloh
Architectural firm: Heitmann Architekten



- 394 Plug-in handles for doors
- 403 Technical information

Plug-in handles for doors

Added value at a glance

Uniquely minimalist: our plug-in handles for doors exude an understated elegance with their minimalist, barely-there roses. Wherever 'less is more' and striking design takes priority, these handles come to the fore with their excellent qualities, both aesthetic and functional.

This plug-in handle is a continuation of the concept that was first brought to life in the form of our plug-in handles for windows – a design that won the Iconic Award 2019 Innovative Interior. This continuity of design is unique on the market and brings with it a large selection of different handle models in aluminium, stainless steel and bronze.

Handle rose with a diameter of 30 mm and depth of 2 mm; concealed fixing

Quick installation of female handles thanks to adaptor system

Approx. 40 different door handle models to suit every style and taste (approx. 30 models also available as plug-in handles for windows; see page 414 ff.)

With and without key rose (WL, PC, WC)

Variable adaptation to door thicknesses 39–68 mm

Full spindle 7, 8 and 8.5 mm



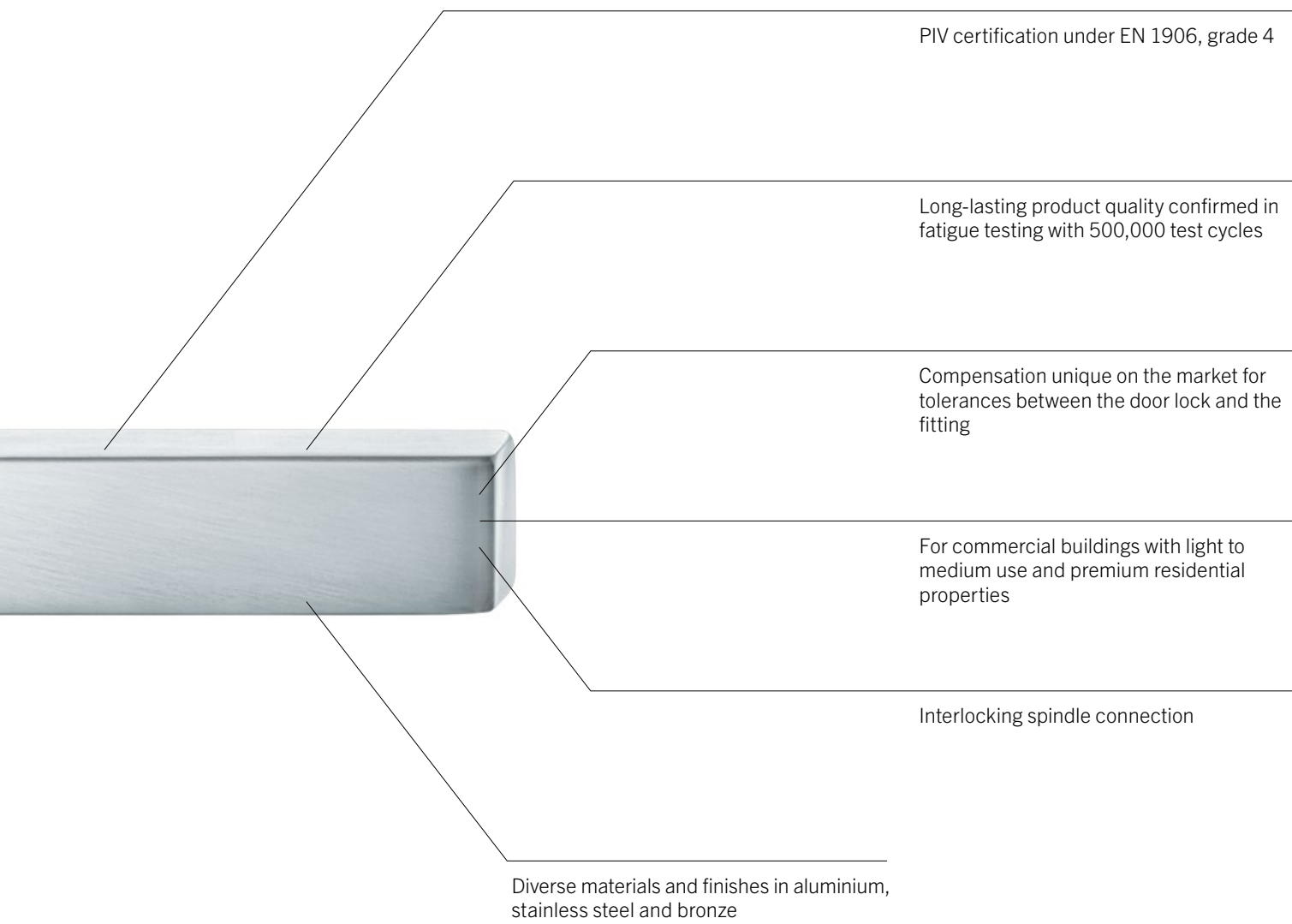

PIV certification under EN 1906, grade 4

Long-lasting product quality confirmed in fatigue testing with 500,000 test cycles

Compensation unique on the market for tolerances between the door lock and the fitting

For commercial buildings with light to medium use and premium residential properties

Interlocking spindle connection

Diverse materials and finishes in aluminium, stainless steel and bronze

6a



Plug-in handles for doors

Product variants

The plug-in handles for doors are available with warded lock (WL), profile cylinder (PC) or WC roses as well as without an additional key rose. The variants are presented on these two pages, using the FSB 1004 model as an example. All of the models shown on pages 400–401 are available in these variants.

Dimensioned drawings of the individual door handle designs shown on pages 400–401 can be found starting on page 76 ff.

Lever/lever set with WL rose

Lever/lever set with PC rose

Lever/lever set with WC rose



- ⇨ 15 01306 (spindle 7 mm)
- ⇨ 15 01302 (spindle 8 mm)
- ⇨ 15 01304 (spindle 8.5 mm)

- ⇨ 15 01316 (spindle 7 mm)
- ⇨ 15 01310 (spindle 8 mm)
- ⇨ 15 01311 (spindle 8.5 mm)

- ⇨ 15 01984 (spindle 7/6 mm)
- ⇨ 15 01954 (spindle 8/8 mm)
- ⇨ 15 01988 (spindle 8.5/7 mm)
- ⇨ 15 01974 (spindle 8/6 mm)

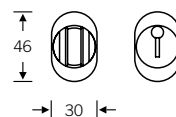
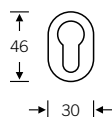
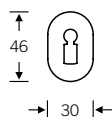
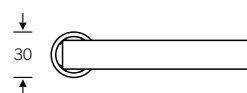
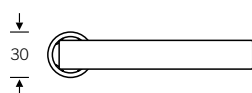
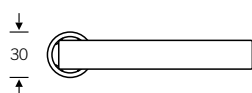

**Lever/lever set
without key rose**



6a

- ⇨ 15 01322 (spindle 7 mm)
- ⇨ 15 01320 (spindle 8 mm)
- ⇨ 15 01321 (spindle 8.5 mm)

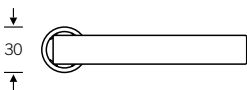

Plug-in handles for doors

Overview

15 1001 
Page 81



15 1003 
Page 86



15 1004 
Page 91



15 1005 
Page 97



15 1015 
Page 103



15 1016 
Page 109



15 1021 
Page 115



15 1023 
Page 119



15 1035 
Page 125



15 1045 
Page 131



15 1051 
Page 137



15 1058 
Page 141



15 1070 
Page 145



15 1075 
Page 151



15 1076 
Page 155



15 1078 
Page 161



15 1093 
Page 167



15 1102 
Page 173



15 1106 
Page 179



15 1107 
Page 185



15 1108 ■ ■
Page 191



15 1119 ■ ■ ■
Page 197



15 1135 ■ ■
Page 203



15 1144 ■ ■
Page 207



15 1146 ■ ■
Page 213



15 1147 ■ ■ ■
Page 219



15 1159 ■ ■ ■
Page 225



15 1160 ■ ■
Page 231



15 1176 ■ ■
Page 243



15 1183 ■ ■ ■
Page 247



15 1226 ■ ■
Page 253



15 1232 ■ ■
Page 257



15 1242 ■ ■ ■
Page 267



15 1244 ■ ■ ■
Page 273



15 1246 ■ ■
Page 279



15 1254 ■ ■
Page 289



15 1267 ■ ■ ■
Page 295



15 1271 ■ ■ ■
Page 301



15 1285 ■ ■
Page 307



403 **Technical information**
Plug-in handles for doors

Technical information

Plug-in handles for doors conforming to EN 1906

Standard EN 1906 defines the requirements and test methods for door handles and doorknobs. The practical value and classification of fittings must be judged across the entire eight-digit grading system.

Perfection down to the last detail – our plug-in handles for doors pass with flying colours in each of the eight categories, also known as ‘digits’:

Certification under EN 1906 is only granted once all test criteria and the required results are met.

Classification code

for plug-in handles for doors (product group 15)
for 8 mm square spindle

| 4 | 7* | – | 0 | 0 | 5 | 0 | U |
|-------------------------------|--------------------------|-----------|------------------------------------------------|----------------------|---------------------------------|------------------------|----------------------------|
| Category of use Grades 1–4 | Durability Grades 6/7 | Door mass | Fire resistance pursuant to EN 1906 Annex C | Safety Grades 0/1 | Corrosion resistance Grade 5 | Security Grades 0–4 | Type of operation A/B/U |

* testing with 500,000 cycles

Technical information

Fixing system for plug-in handles for doors

Installing the handle rose

Installing the FSB plug-in handle for doors is easy: first, a hole is created in the door for the clamping roses, which are suitable for a diameter of 26 or 27 mm. The hole can be made using CNC technology or also manually using a hole saw available from FSB (03 0416 01012 5000). The handle rose is then inserted into the hole and clamped using the special tool supplied. Next comes the installation of the square

spindle, which has to go straight through the centre of the hole. The adaptors are placed on the spindle, which is aligned in the lock follower, and tightened with screws until there is no play. The cover roses and plug-in handles can then be installed.

Installing the key roses

The supplementary key roses are adhesive roses that are aligned with a template on the door and then secured with double-sided adhesive tape. The adhesive tape is white for finishes 0105, 0205, 6204 and 6205, and black for finishes 0410, 0510, 0710, 0810 and for dark RAL and bronze tones.

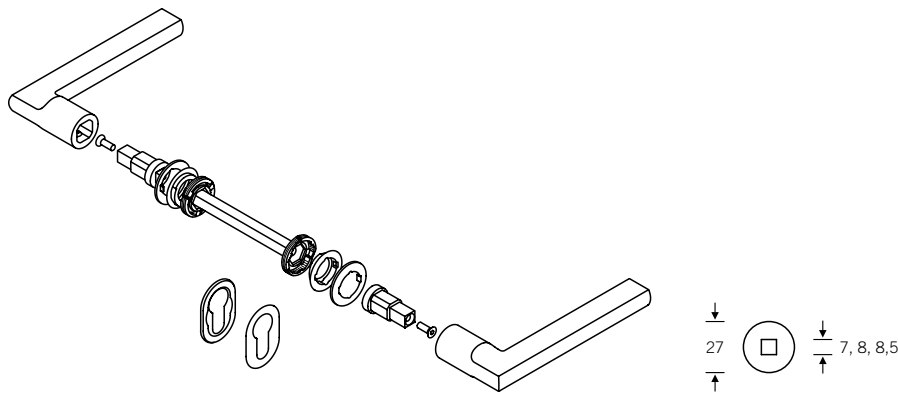

Hole saw 03 0416 01012 5000

6a

For doors with WL and PC rose

15 **013**..

- ...06 (WL, spindle 7 mm)
- ...02 (WL, spindle 8 mm)
- ...04 (WL, spindle 8.5 mm)
- ...16 (PC, spindle 7 mm)
- ...10 (PC, spindle 8 mm)
- ...11 (PC, spindle 8.5 mm)

For doors without key rose

15 **013**..

- ...22 (spindle 7 mm)
- ...20 (spindle 8 mm)
- ...21 (spindle 8.5 mm)

For doors with WC rose

15 **019**..

- ...84 (spindle 7/6 mm)
- ...54 (spindle 8/8 mm)
- ...88 (spindle 8.5/7 mm)
- ...74 (spindle 8/6 mm)



- 406 Fittings for windows
- 422 Tee handles for windows
- 426 Window handles for specific requirements
- 428 Lockable window handles
- 439 Parallel slide/tilt fittings
- 442 Lifting/sliding door fittings
- 453 Technical information

Fittings for windows

Added value at a glance

Bolted, latched or lockable, whatever the variant our window handles will give you years of enjoyment. Awarded the RAL quality seal, they can withstand over 100,000 operational cycles under practical conditions without sustaining notable wear. This means that our window handles will continue to serve their purpose well for more than 25 years, even if the window is opened/closed ten times every day.

Certified under EN 13126-3

25,000 tested operational cycles

150,000 click-stop events, 180° turn/tilt cycles: RAL quality seal criteria, which only requires 10,000 turn/tilt cycles at 180°, exceeded by 15 times

Highest durability rating 5/180

Certified under RAL-GZ 607/9

Consistent, sustainable,
high-quality and functional

Selected handle designs also
available as lifting/sliding door
handles

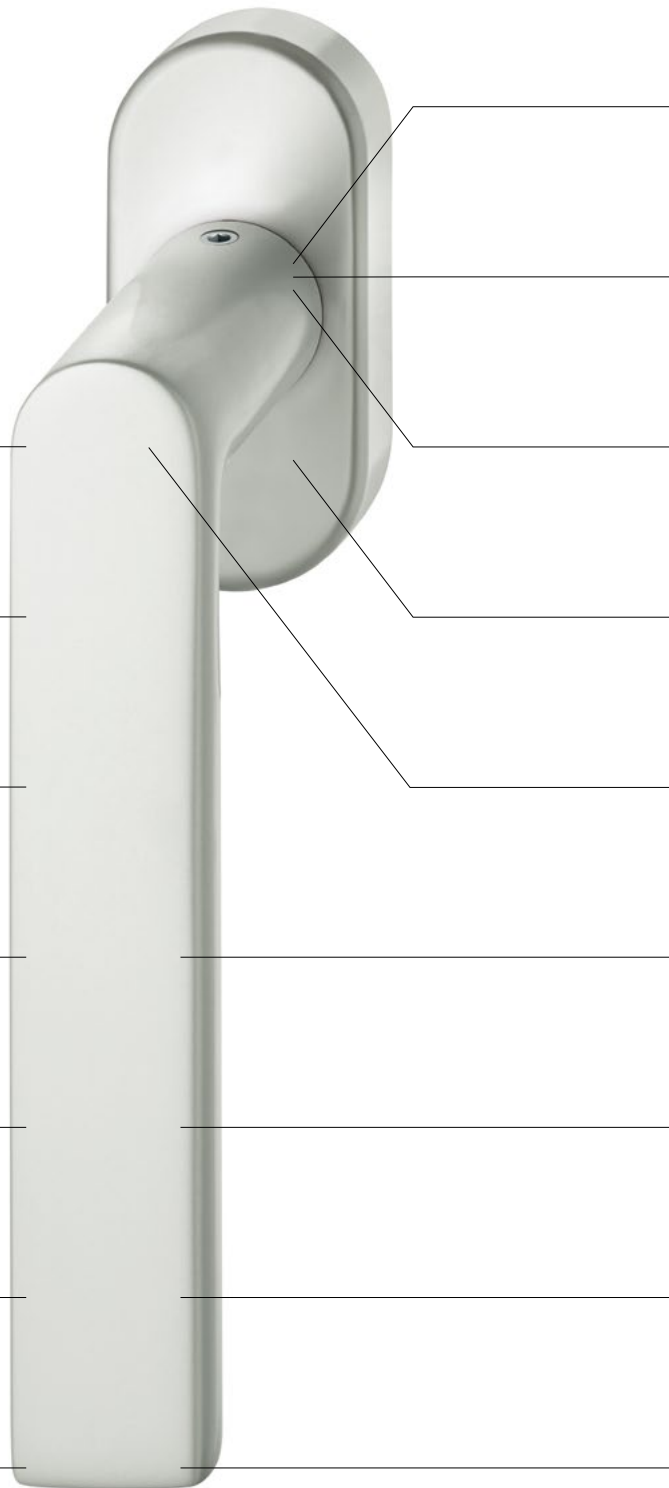

Click-stop mechanism ensures tangible and audible positioning in 90° increments: open, close, tilt

Increased stability and durability through stainless steel reinforcement combined with GFR plastic in the rose

Over 100,000 operational cycles without notable wear: handle will continue to serve its purpose well over more than 25 years, even if the window is opened/closed ten times every day

Round/angular, surface-mounted/flush-fitted and narrow roses as well as plug-in handle variants available

Square spindle with variable projection makes project planning easier

Secure hold with < 0.15 mm free play, so sets have no room to wobble

Optimal installation process: screw the base together, push on the rose and window handle, tighten – job done!

Numerous window handles can be retrofit with securing device

Custom concept solutions available upon request, such as cranking for top-hinged sash windows

Fittings for windows

Product variants

Product features of window handles

- Equipped with click-stop mechanism
- Highest durability rating 5/180 under EN 13126-3
- Concealed fixing
- Cover rose clips onto rose base
- Distance between fixing points 43 mm
- Square spindle 7 mm
- RAL-certified
- 25,000 tested turn/tilt cycles
- At least 120 h corrosion resistance verified by salt spray test
- Length of spindle accommodated within the adaptor at least 25 mm

Standard window handle



34 09039 (oval rose)
34 09040 (angular rose)

- Surface-mounted rose
- Rose dimensions: 32.5 × 70 × 10 mm (w × h × d)
- Lug Ø 10 mm
- Variable spindle projection of 24–38 mm (supplied as standard)

Window handles for narrow profiles



34 09030 (oval rose)
34 09032 (angular rose)

- Surface-mounted rose
- Rose dimensions: 27 × 62 × 10 mm (w × h × d)
- Lug Ø 10 mm
- Variable spindle projection of 24–38 mm (supplied as standard)

Flush-fitted window handles



34 09034 (oval rose)
34 09036 (angular rose)

- Recessed flush-fitted rose
- Rose dimensions: 25.5 × 60.5 × 10.2 mm (w × h × d)
- Variable spindle projection of 14–28 mm
- For custom spindle projection, please specify when ordering
- The following models are not available as flush-fitted variants: FSB 1021, 1045, 1058, 1135, 1163, 1176, 1226

Product features of lockable window handles

- Equipped with click-stop mechanism
- Highest durability rating 5/180 under EN 13126-3
- Numerous window handles can be combined with lock adaptors
- Surface-mounted rose with concealed fixing
- Cover rose clips onto rose base
- Distance between fixing points 43 mm
- Rose dimensions: 32.5 × 84.5 × 21 mm (w × h × d)
- Square spindle 7 mm
- Certified under quality standard RAL-GZ 607/9
- Awarded quality seal
- Over 25,000 tested turn/tilt cycles
- At least 120 h corrosion resistance verified by salt spray test
- 200 Nm resistance against twisting-off and forcing-off, which is twice the minimum requirement of the standard
- For resistance class RC 1 to RC 6 pursuant to EN 1627 – 1630, unlimited use on burglary-resistant elements

Lockable window handles with key



34 170 (oval rose)
34 180 (angular rose)

- Locking mechanism with at least 100 possible locking variations
- Spindle projection 34 mm (supplied as standard)

Lockable window handles with push-button



34 076 (oval rose)
34 086 (angular rose)

- Two-handed operation required
- Window handles with push-button are always locked; the window is opened by pushing the button and turning the handle.
- Makes outside tampering more difficult
- Forgetting to lock the window handle is now a thing of the past
- Spindle projection 34 mm (supplied as standard)

Window handles with automatic locking and 'tilt-to-turn' function

All lockable FSB window handles can be equipped with automatic locking. To remove the key, it must be parallel to the window profile in the 'locked' position. This serves as a visual aid to the user as well, allowing them to determine at a glance whether the window is locked. In the case of window handles without automatic locking, the key can be pulled out irrespective of the position.

The 'tilt-to-turn' function prevents unauthorised users from opening the window fully without sacrificing adequate ventilation. The window can be tilted open when closed. For this function both the window handle and the window drive must support and be fitted for this function. Moreover, please note that these window handles do not conform to the RAL quality standard or to EN 1627 – 1630.

6b

Plug-in handles

Product variants

For the complete product code, simply replace the full stops (....) with the desired model number

Product features of plug-in handles

- Equipped with click-stop mechanism
- Highest durability rating 5/180 under EN 13126-3
- Suitable for burglary-resistant elements pursuant to EN 1267–1630
- Surface-mounted rose
- Rose format Ø 30 mm
- Concealed fixing
- Cover rose clips onto rose base
- Installation does not depend on window drive
- Square spindle 7 mm

Plug-in handles for timber, metal and PVC windows



- 34 711 (for metal profiles)
- 34 711 (for timber profiles)
- 34 751 (for PVC profiles)

Additional fixing accessories are needed for timber windows:
03 0401 00003 0400

- Variable spindle projection 24–38 mm
- Rose secured to the profile via clamping mechanism

Lockable plug-in handles for timber and metal windows



- 34 714 (with key)
- 34 717 (with push-button)

Additional fixing accessories are needed for timber windows:
03 0401 00003 0400

- Variable spindle projection 24–38 mm
- Suitable for burglary-resistant elements pursuant to EN 1267–1630
- Certified for 100 Nm resistance against twisting-off and forcing-off

Fittings for windows

Overview

Window handles in the FSB product collections

34 1001 ■
Page 81



34 1003 ■ ■
Page 86



34 1004 ■ ■ ■
Page 91



34 1005 ■ ■
Page 97



34 1015 ■ ■ ■
Page 103



34 1021 ■ ■
Page 115



34 1023 ■ ■ ■
Page 119



34 1035 ■ ■
Page 125



34 1058 ■ ■
Page 141



34 1070 ■ ■
Page 145



34 1075 ■ ■
Page 151



34 1076 ■ ■ ■
Page 155



34 1078 ■ ■
Page 161



34 1093 ■ ■
Page 167



34 1102 ■ ■ ■
Page 173



34 1106 ■ ■ ■
Page 179



34 1107 ■ ■
Page 185



34 1108 ■ ■
Page 191



34 1135 ■
34 1106 ■ ■ ■
Page 203



34 1144 ■ ■
Page 207



34 1146 ■ ■
Page 213



34 1147 ■ ■
Page 219



6b

34 1159 ■ ■
Page 225



34 1160 ■ ■
Page 231



34 1163 ■ ■ ■
34 3453 ■
Page 237



34 1176 ■ ■
Page 243



34 1183 ■ ■
Page 247



Fittings for windows

Overview

Window handles in the FSB product collections

34 1226 ■
Page 253



34 1232 ■
Page 257



34 1241 ■
Page 263



34 1242 ■ ■ ■
Page 267



34 1244 ■ ■
Page 273



34 1246 ■
Page 279



34 1251 ■ ■
Page 285



34 1254 ■
343454 ■
Page 289



34 1267 ■ ■ ■
Page 295



34 1271 ■ ■
Page 301



34 1285 ■
Page 307



Roses

34 0000 09030
 34 0000 09039
 Page 381



34 0000 09032
 34 0000 09040
 Page 381



Lockable roses

34 0000 170
 Page 382



34 0000 180
 Page 382



34 0000 076
 Page 382



34 0000 086
 Page 382



6b

Roses for plug-in handles

34 0000 71101
 34 0000 75101
 Page 383



03 0401 00003
 Page 383



Fittings for windows

Overview

Tee handles for windows

34 3401 ■
Page 422



34 3402 ■
Page 422



34 3403 ■ ■
Page 424



34 3499 ■
Page 424



34 3404 ■
Page 422



34 3453 ■ ■
Page 424



34 3454 ■
Page 425



34 3455 ■
Page 425



34 3480 ■
Page 423



34 3784 ■ ■
Page 425



Lockable window handles

34 ... 170 ■ ■ ■
Page 428



34 ... 180 ■ ■ ■
Page 429



34 ... 076 ■ ■ ■
Page 430



34 ... 086 ■ ■ ■
Page 431



Illustrative example featuring model 1076

Lockable window handles

34 3460 ■ ■ ■
 34 3471 ■ ■
 Page 432



34 3481 ■
 Page 433



34 3488 ■
 Page 433



34 3491 ■ ■
 Page 435 ff.



34 3495 ■
 Page 435 ff.



34 3496 ■
 Page 434



Window handles

for specific requirements

34 3499 ■
 Page 426



34 3499 ■
 Page 427



Budget lock roses, securing devices

17 1759 ■ ■
 Page 438



17 1786 ■ ■
 Page 438



34 3407 ■ ■
 Page 437



34 3416 ■
 Page 437



6b

Fittings for windows

Overview

Lifting/sliding door handles

34 1004 ■ ■
Page 442



34 1016 ■ ■
Pages 439, 443



34 1076 ■ ■
Pages 439, 444



34 1102 ■ ■
Page 446



34 1146 ■ ■
Pages 440, 447



34 1163 ■ ■
Page 445



34 1242 ■ ■
Page 448



Parallel slide / tilt fittings

34 1016 ■ ■
Page 439

34 1076 ■
Page 439

34 1146 ■ ■
Page 440



6b

Recessed handles

for opposite face

42 4215 ■ ■ ■
Pages 441, 449

42 4217 ■ ■
Page 450



Fittings for windows

Tee handles for windows

- Aluminium
- Stainless steel
- Bronze

34 3401 ■

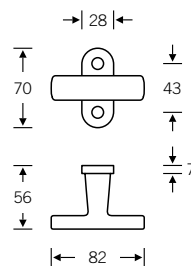

34 3402 ■

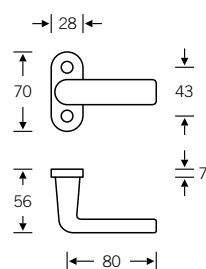

34 3404 ■

Design: Johannes Potente

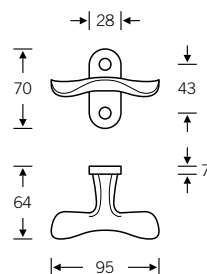

The window handles shown here are not suitable for heavy-duty applications.

Screws are not included in the scope of delivery.

Fittings for windows

Tee handles for windows

- Aluminium
- Stainless steel
- Bronze

34 3480 ■

Not suitable for heavy-duty applications

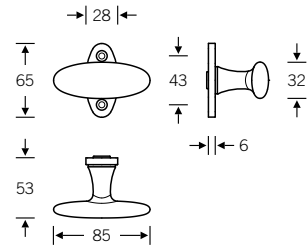

6b

Screws are not included in the scope of delivery.

Fittings for windows

Tee handles for windows

- Aluminium
- Stainless steel
- Bronze

34 3403 



34 3403 09039
34 3403 170 (lockable)
34 3403 076 (push-button)

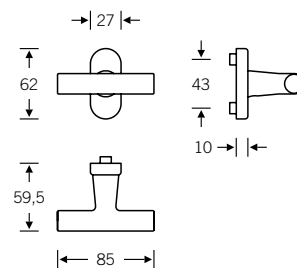

34 3499 



34 3499 00012 (shorter handle neck)

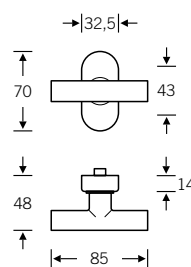

34 3453 

Design: Hans Kollhoff



34 3453 09040

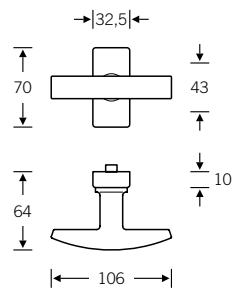

Fittings for windows

Tee handles for windows

- Aluminium
- Stainless steel
- Bronze

34 3454 ■

34 3454 09039

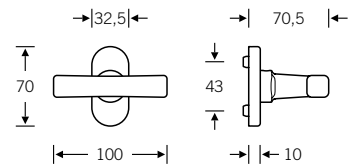

34 3455 ■

34 3455 09039

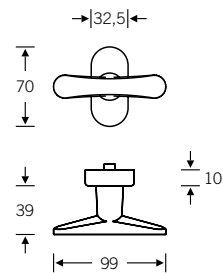

6b

34 3784 ■ ■

Design: Heike Falkenberg

34 3784 09040

34 3784 180 (lockable)

34 3784 086 (push-button)

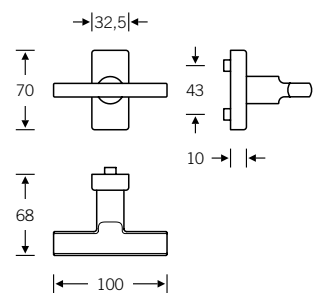

Fittings for windows

Window handles for specific requirements

- Aluminium
- Stainless steel
- Bronze

34 3499 ■

34 3499 00039 (R) | 34 3499 00040 (L)

Matching model 1023

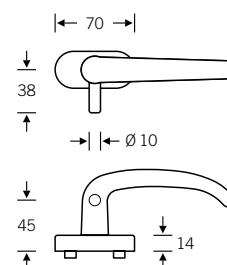

34 3499 ■

34 3499 00036 (R) | 34 3499 00037 (L)

Matching model 1076

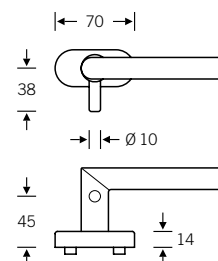

Window handles without variable spindle projection; please specify the desired projection when ordering

Not suitable for centre-hung sashes by Hautau

Fittings for windows

Window handles for specific requirements

- Aluminium
- Stainless steel
- Bronze

34 3499 ■

34 3499 00033

Matching model 1023

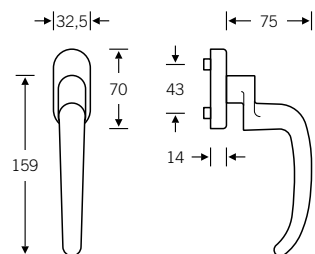

34 3499 ■

34 3499 00018 (R) | 34 3499 00019 (L)

Matching model 1076

Model pictured: right

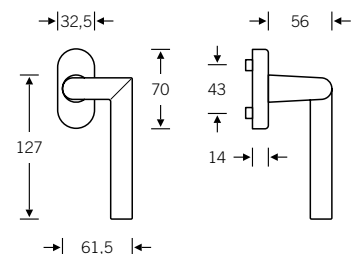

6b



Window handles without variable spindle projection; please specify the desired projection when ordering

Fittings for windows

Lockable window handles with lock cylinder

- Aluminium
- Stainless steel
- Bronze

34



34 170 (oval with lock cylinder)

Can be combined with almost all FSB handle models; see page 414 ff.

Lock cylinder can be fitted pointing up or down; see picture

Rated as burglary-resistant pursuant to EN 1627 ff.

Option with automatic locking, where the lock cylinder has to be locked in order to remove the key

Keys to differ or keys alike

'Tilt-to-turn' function possible (not rated as burglary-resistant pursuant to EN 1627 ff. and without RAL quality seal); please specify DIN handing when ordering and indicate whether lock cylinder should point up or down

Illustrative example featuring FSB 1076

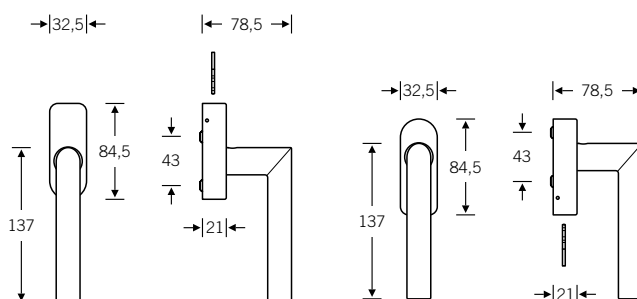

Click-stop mechanism + security

Spindle projection 34 mm; for different spindle projections please specify when ordering

Fittings for windows

Lockable window handles with lock cylinder

- Aluminium
- Stainless steel
- Bronze

34 



34 180 (angular with lock cylinder)

Can be combined with almost all FSB handle models; see page 414 ff.

Lock cylinder can be fitted pointing up or down; see picture

Rated as burglary-resistant pursuant to EN 1627 ff.

Option with automatic locking, where the lock cylinder has to be locked in order to remove the key

Keys to differ or keys alike

'Tilt-to-turn' function possible (not rated as burglary-resistant pursuant to EN 1627 ff. and without RAL quality seal); please specify DIN handing when ordering and indicate whether lock cylinder should point up or down

Illustrative example featuring FSB 1076

6b

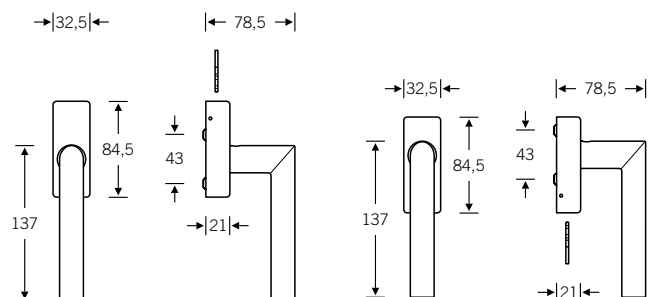

Click-stop mechanism + security

Spindle projection 34 mm; for different spindle projections please specify when ordering

Fittings for windows

Lockable window handles with push-button

- Aluminium
- Stainless steel
- Bronze

34 



34 076 (oval with push-button)

Can be combined with almost all FSB handle models; see page 414 ff.

Push-button can be fitted pointing up or down; see picture

Push-button requires two-handed operation and makes access from outside more difficult

Rated as burglary-resistant pursuant to EN 1627 ff.

Illustrative example featuring FSB 1076

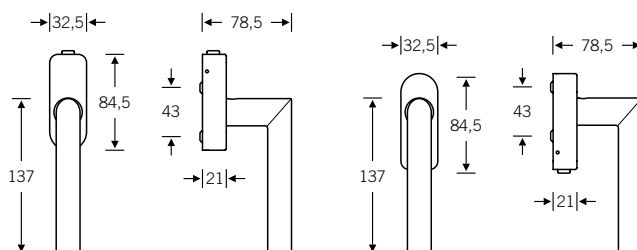

Click-stop mechanism + security

Spindle projection 34 mm; for different spindle projections please specify when ordering

Fittings for windows

Lockable window handles with push-button

- Aluminium
- Stainless steel
- Bronze

34 



34 086 (angular with push-button)

Can be combined with almost all FSB handle models; see page 414 ff.

Push-button can be fitted pointing up or down; see picture

Push-button requires two-handed operation and makes access from outside more difficult

Rated as burglary-resistant pursuant to EN 1627 ff.

Illustrative example featuring FSB 1076

6b

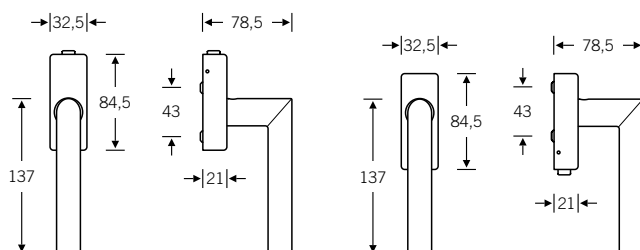

Click-stop mechanism + security

Spindle projection 34 mm; for different spindle projections please specify when ordering

Fittings for windows

Lockable window-handle roses

- Aluminium
- Stainless steel
- Bronze

34 3460



34 3460 170
Automatic locking device with ball catch

Matching operating handle 34 1076 09001 in stainless steel must be ordered separately

Adaptor can be fitted pointing up or down

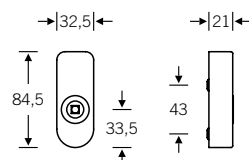

34 1076

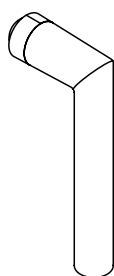

34 1076 09001
Operating handle

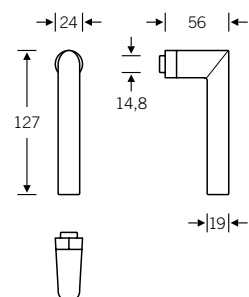

34 3471



Automatic locking device with ball catch

Matching operating handle 34 3403 09000 in aluminium must be ordered separately

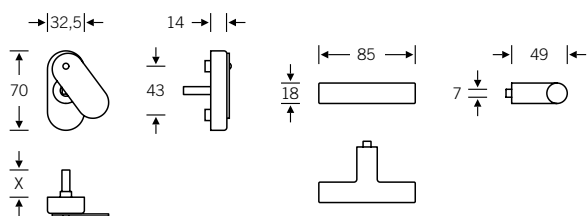

34 3471

34 3403

Fittings for windows

Lockable window handles

■ Aluminium
■ Stainless steel
■ Bronze

34 3488 ■



34 3488 000 (not lockable)

34 3488 021 (lockable)

Rated as burglary-resistant pursuant to EN 1627 ff.; options of keys to differ, keys alike and 'tilt-to-turn'*; only available without automatic locking

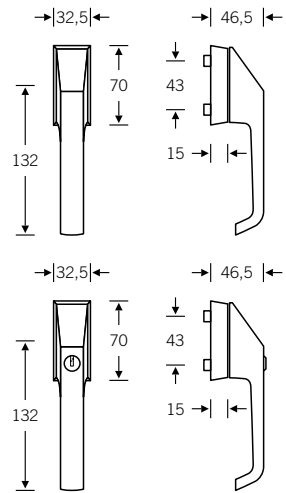

34 3481 ■



Rated as burglary-resistant pursuant to EN 1627 ff.; options of keys to differ, keys alike and 'tilt-to-turn'*; only available without automatic locking

6b

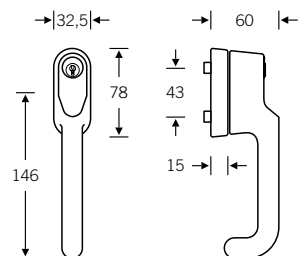

Click-stop mechanism + security

Spindle projection 34 mm; for different spindle projections please specify when ordering

* Not rated as burglary-resistant pursuant to EN 1627 ff. and without RAL quality seal; specify DIN handing when ordering

Fittings for windows

Lockable window handles

- Aluminium
- Stainless steel
- Bronze

34 3496 ■

34 3496 000

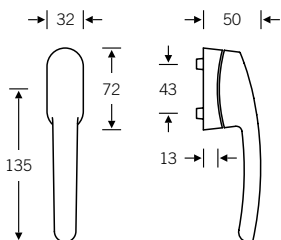

34 3496 ■

34 3496 021

Rated as burglary-resistant pursuant to EN 1627 ff.; options of keys to differ, keys alike and 'tilt-to-turn'*; only available without automatic locking

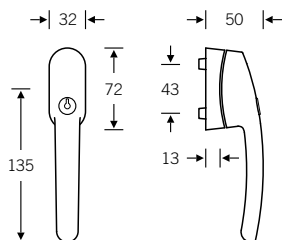

Spindle projection 34 mm; for different spindle projections please specify when ordering

* Not rated as burglary-resistant pursuant to EN 1627 ff. and without RAL quality seal; specify DIN handing when ordering

Fittings for windows

Lockable window handles

■ Aluminium
■ Stainless steel
■ Bronze

34 3495 ■

34 3495 00059

Rated as burglary-resistant pursuant to EN 1627 ff.; fitted for single-profile cylinder; option of 'tilt-to-turn'*; max. cylinder length 40 mm; only compatible with cylinders with adjustable throwers; option fitted for single-profile cylinder Winkhaus BC0217Z49

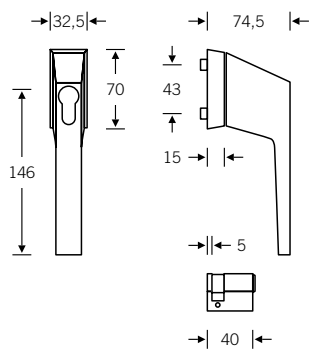

34 3491 ■ ■

34 3491 00059

Rated as burglary-resistant pursuant to EN 1627 ff.; fitted for single-profile cylinder; option of 'tilt-to-turn'*; option fitted for single-profile cylinder 34 3491 00008, Winkhaus BC02X3: 25 2500 08207 4504; max. cylinder length 40 mm; only compatible with cylinders with adjustable throwers

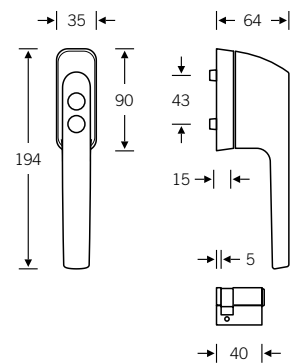

6b



Click-stop mechanism + security

Spindle projection 34 mm; for different spindle projections please specify when ordering

* Not rated as burglary-resistant pursuant to EN 1627 ff. and without RAL quality seal; specify DIN handing when ordering

Fittings for windows

Lockable window handles

- Aluminium
- Stainless steel
- Bronze

34 3495 ■

34 3495 01009

Rated as burglary-resistant pursuant to EN 1627 ff.; fitted for single-profile cylinder; option of 'tilt-to-turn'*; max. cylinder length 40 mm; only compatible with cylinders with adjustable throwers



34 3491 ■ ■

34 3491 01009

Rated as burglary-resistant pursuant to EN 1627 ff.; fitted for single-profile cylinder; option of 'tilt-to-turn'* (design differs slightly); max. cylinder length 40 mm; only compatible with cylinders with adjustable throwers

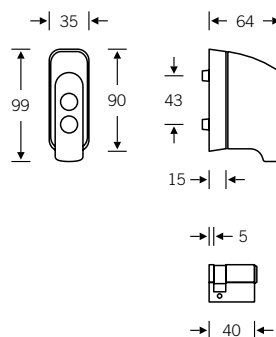
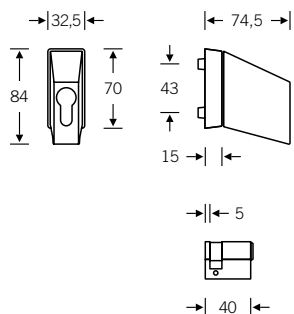

Click-stop mechanism + security

Spindle projection 30 mm; for different spindle projections please specify when ordering

* Not rated as burglary-resistant pursuant to EN 1627 ff. and without RAL quality seal; specify DIN handing when ordering

Fittings for windows

Window securing devices

- Aluminium
- Stainless steel
- Bronze

34 3407 ■ ■

34 3407 02185
 Securing device for FSB window handles
 with oval rose 70 × 32.5 mm
 (34 09039)

Not rated as burglary-resistant pursuant to
 EN 1627 ff.

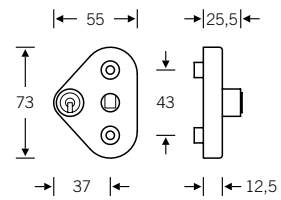

34 3416 ■

Anti-leverage device

6b

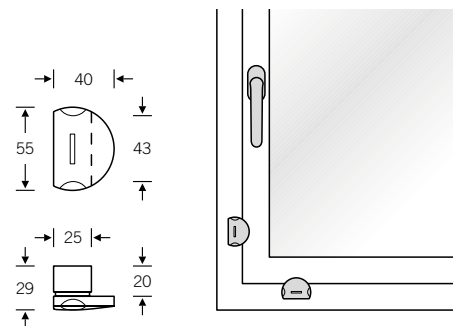

Fittings for windows

Budget lock roses

- Aluminium
- Stainless steel
- Bronze

17 1759



17 1759 025 (no flap)
 17 1759 026 (with oval flap
 for vertical use)
 17 1759 027 (with round flap
 for horizontal use)
 Matching operating handle
 34 3402 09000 in aluminium must be
 ordered separately

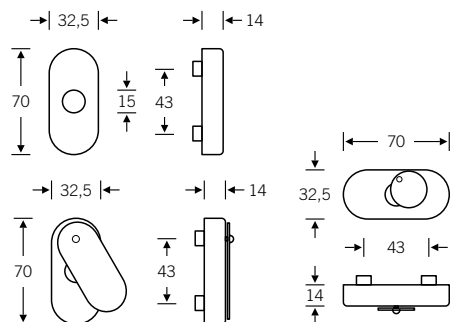

17 1786



17 1786 025 (no flap)
 17 1786 026 (with angular flap
 for vertical use)
 Matching operating handle
 34 3402 09000 in aluminium must be
 ordered separately

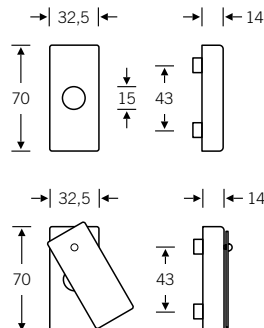

34 3402



34 3402 09000
 Operating handle

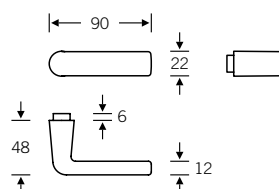

Fittings for windows

Parallel slide/tilt fittings (PST)

- Aluminium
- Stainless steel
- Bronze

34 1016 ■

34 1076 ■



Parallel slide/tilt fittings with 90° click-stop mechanism, turnably fixed, concealed fixing, square spindle 7 and 8 mm

.... 01202

No keyway, with M6 × 80 mm screws, for back-to-back fixing with FSB 42 4215

... 01203

Profile cylinder (PC) keyway, with M6 × 80 mm screws, for back-to-back fixing with FSB 42 4215

6b

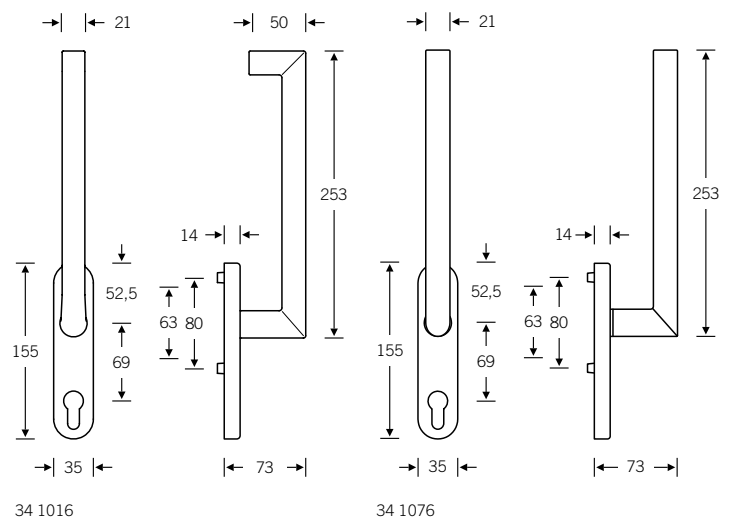

For matching FSB 42 4215 recessed handles, see page 441

Fittings for windows

Parallel slide/tilt fittings (PST)

- Aluminium
- Stainless steel
- Bronze

34 1146 



Parallel slide/tilt fittings with 90° click-stop mechanism, turnably fixed, concealed fixing, square spindle 7 and 8 mm

.... 01202

No keyway, with M6 × 80 mm screws, for back-to-back fixing with FSB 42 4215

... 01203

Profile cylinder (PC) keyway, with M6 × 80 mm screws, for back-to-back fixing with FSB 42 4215

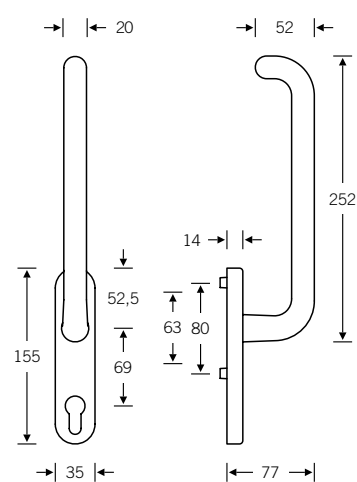

For matching FSB 42 4215 recessed handles, see page 441

Fittings for windows

Recessed handles for PST opposite face

- Aluminium
- Stainless steel
- Bronze

42 4215 ■

42 4215 00100 (no keyway)
42 4215 00102 (PC keyway)

M6 threaded screws

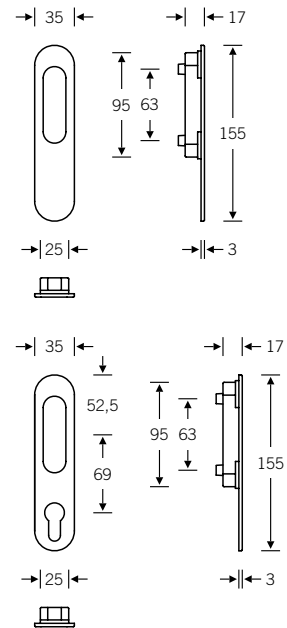
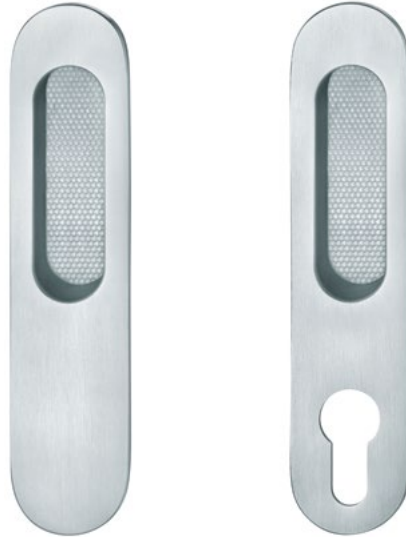

42 4215 ■

42 4215 01100

M6 threaded screws

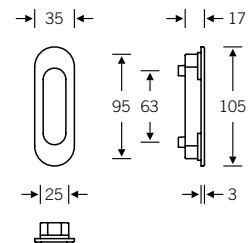

6b

Fittings for windows

Lifting/sliding door fittings

■ Aluminium
■ Stainless steel
■ Bronze

34 1004 ■ ■



Lifting/sliding door handles with 180° click-stop mechanism, turnably fixed, concealed fixing, square spindle 10 mm

... 01100 (oval)
 ... 02100 (angular)
 – No keyway
 – M6 threaded lugs
 – For back-to-back fixing with variant 01102 (oval) or variant 02102 (angular)

... 01101 (oval)
 ... 02101 (angular)
 – PC keyway
 – M6 threaded lugs
 – For back-to-back fixing with variant 01103 (oval) or variant 02103 (angular)

... 01102 (oval)
 ... 02102 (angular)
 – No keyway
 – M6 × 80 mm screws
 – For back-to-back fixing with 42 4215 (oval) or variant 01100, or 42 4217 (angular) or variant 02100

... 01103 (oval)
 ... 02103 (angular)
 – PC keyway
 – M6 × 80 mm screws
 – For back-to-back fixing with 42 4215 (oval) or variant 01101, or 42 4217 (angular) or variant 02101

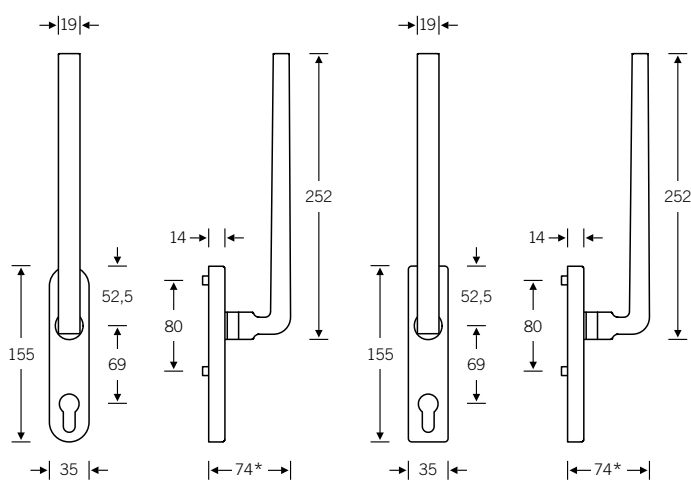

* Aluminium and bronze 74 mm, stainless steel 71 mm

For matching FSB 42 4215 and 42 4217 recessed handles, see page 449 f.

Fittings for windows

Lifting/sliding door fittings

■ Aluminium
■ Stainless steel
■ Bronze

34 1016 ■ ■



Lifting/sliding door handles with 180° click-stop mechanism, turnably fixed, concealed fixing, square spindle 10 mm

... 01100 (oval)
 ... 02100 (angular)
 – No keyway
 – M6 threaded lugs
 – For back-to-back fixing with variant 01102 (oval) or variant 02102 (angular)

... 01101 (oval)
 ... 02101 (angular)
 – PC keyway
 – M6 threaded lugs
 – For back-to-back fixing with variant 01103 (oval) or variant 02103 (angular)

... 01102 (oval)
 ... 02102 (angular)
 – No keyway
 – M6 × 80 mm screws
 – For back-to-back fixing with 42 4215 (oval) or variant 01100, or 42 4217 (angular) or variant 02100

... 01103 (oval)
 ... 02103 (angular)
 – PC keyway
 – M6 × 80 mm screws
 – For back-to-back fixing with 42 4215 (oval) or variant 01101, or 42 4217 (angular) or variant 02101

6b

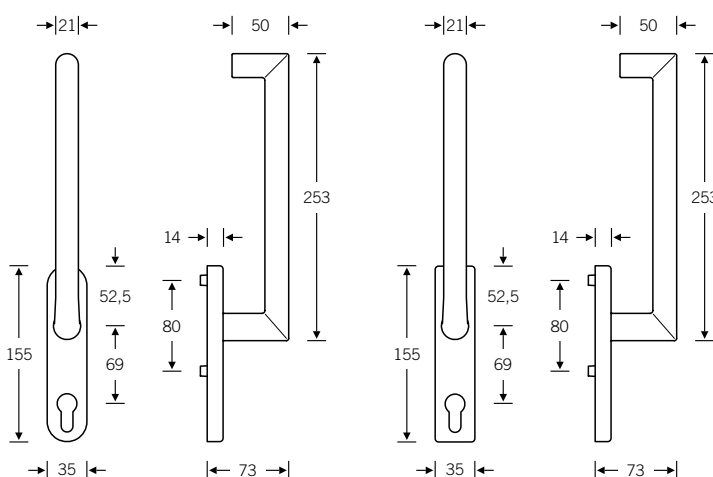

For matching FSB 42 4215 and 42 4217 recessed handles, see page 449 f.

Fittings for windows

Lifting/sliding door fittings

■ Aluminium
■ Stainless steel
■ Bronze

34 1076 ■



Lifting/sliding door handles with 180° click-stop mechanism, turnably fixed, concealed fixing, square spindle 10 mm

... 01100 (oval)
 ... 02100 (angular)
 – No keyway
 – M6 threaded lugs
 – For back-to-back fixing with variant 01102 (oval) or variant 02102 (angular)

... 01101 (oval)
 ... 02101 (angular)
 – PC keyway
 – M6 threaded lugs
 – For back-to-back fixing with variant 01103 (oval) or variant 02103 (angular)

... 01102 (oval)
 ... 02102 (angular)
 – No keyway
 – M6 × 80 mm screws
 – For back-to-back fixing with 42 4215 (oval) or variant 01100, or 42 4217 (angular) or variant 02100

... 01103 (oval)
 ... 02103 (angular)
 – PC keyway
 – M6 × 80 mm screws
 – For back-to-back fixing with 42 4215 (oval) or variant 01101, or 42 4217 (angular) or variant 02101

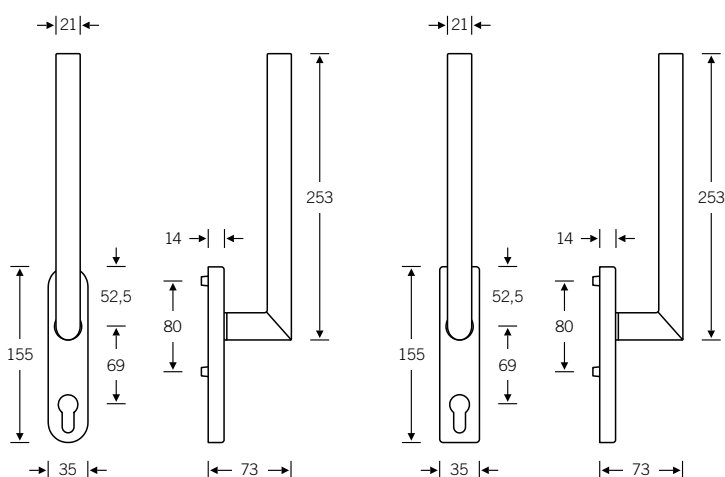

For matching FSB 42 4215 and 42 4217 recessed handles, see page 449 f.

Fittings for windows

Lifting/sliding door fittings

■ Aluminium
■ Stainless steel
■ Bronze

34 1163 ■



Lifting/sliding door handles with 180° click-stop mechanism, turnably fixed, concealed fixing, square spindle 10 mm

... 01100 (oval)
 ... 02100 (angular)
 – No keyway
 – M6 threaded lugs
 – For back-to-back fixing with variant 01102 (oval) or variant 02102 (angular)

... 01101 (oval)
 ... 02101 (angular)
 – PC keyway
 – M6 threaded lugs
 – For back-to-back fixing with variant 01103 (oval) or variant 02103 (angular)

... 01102 (oval)
 ... 02102 (angular)
 – No keyway
 – M6 × 80 mm screws
 – For back-to-back fixing with 42 4215 (oval) or variant 01100, or 42 4217 (angular) or variant 02100

... 01103 (oval)
 ... 02103 (angular)
 – PC keyway
 – M6 × 80 mm screws
 – For back-to-back fixing with 42 4215 (oval) or variant 01101, or 42 4217 (angular) or variant 02101

6b

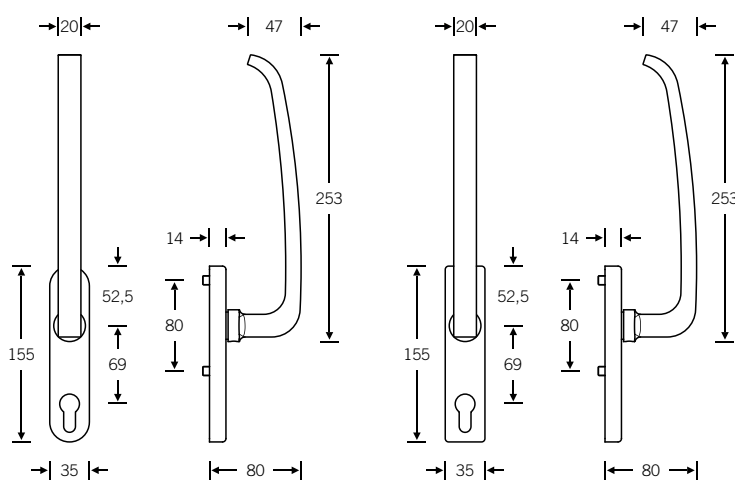

For matching FSB 42 4215 and 42 4217 recessed handles, see page 449 f.

Fittings for windows

Lifting/sliding door fittings

■ Aluminium
■ Stainless steel
■ Bronze

34 1102 ■



Lifting/sliding door handles with 180° click-stop mechanism, turnably fixed, concealed fixing, square spindle 10 mm

... 01100 (oval)
 ... 02100 (angular)
 – No keyway
 – M6 threaded lugs
 – For back-to-back fixing with variant 01102 (oval) or variant 02102 (angular)

... 01101 (oval)
 ... 02101 (angular)
 – PC keyway
 – M6 threaded lugs
 – For back-to-back fixing with variant 01103 (oval) or variant 02103 (angular)

... 01102 (oval)
 ... 02102 (angular)
 – No keyway
 – M6 × 80 mm screws
 – For back-to-back fixing with 42 4215 (oval) or variant 01100, or 42 4217 (angular) or variant 02100

... 01103 (oval)
 ... 02103 (angular)
 – PC keyway
 – M6 × 80 mm screws
 – For back-to-back fixing with 42 4215 (oval) or variant 01101, or 42 4217 (angular) or variant 02101

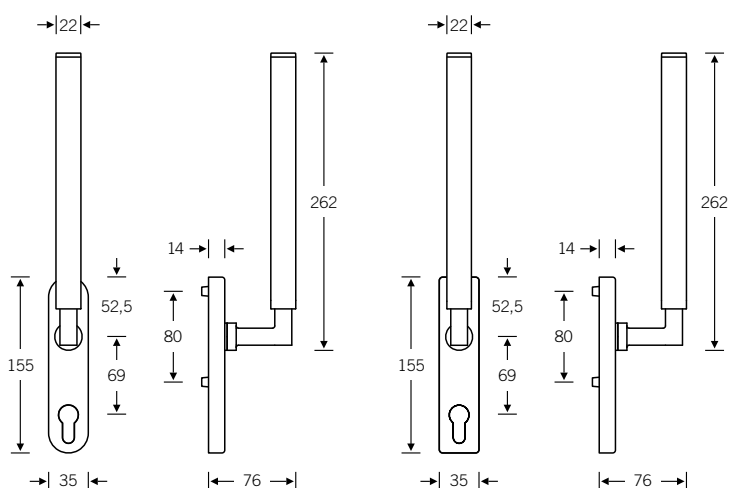

For matching FSB 42 4215 and 42 4217 recessed handles, see page 449 f.

Fittings for windows

Lifting/sliding door fittings

■ Aluminium
■ Stainless steel
■ Bronze

34 1146 ■ ■



Lifting/sliding door handles with 180° click-stop mechanism, turnably fixed, concealed fixing, square spindle 10 mm

- ... 01100 (oval)
- ... 02100 (angular)
- No keyway
- M6 threaded lugs
- For back-to-back fixing with variant 01102 (oval) or variant 02102 (angular)

- ... 01101 (oval)
- ... 02101 (angular)
- PC keyway
- M6 threaded lugs
- For back-to-back fixing with variant 01103 (oval) or variant 02103 (angular)

- ... 01102 (oval)
- ... 02102 (angular)
- No keyway
- M6 × 80 mm screws
- For back-to-back fixing with 42 4215 (oval) or variant 01100, or 42 4217 (angular) or variant 02100

- ... 01103 (oval)
- ... 02103 (angular)
- PC keyway
- M6 × 80 mm screws
- For back-to-back fixing with 42 4215 (oval) or variant 01101, or 42 4217 (angular) or variant 02101

6b

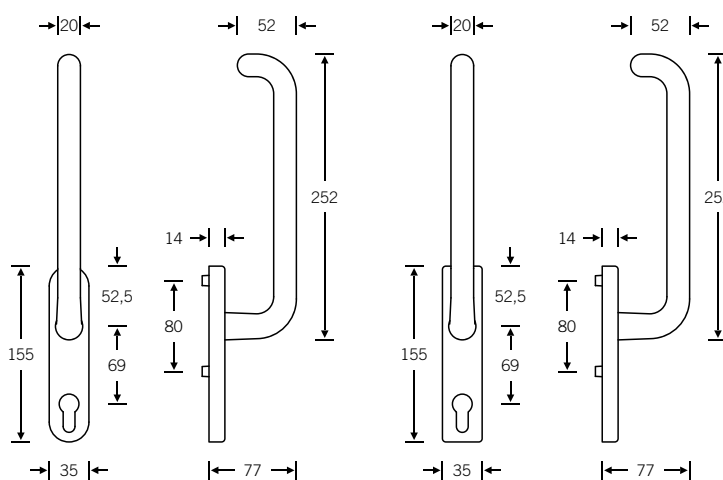

For matching FSB 42 4215 and 42 4217 recessed handles, see page 449 f.

Fittings for windows

Lifting/sliding door fittings

■ Aluminium
■ Stainless steel
■ Bronze

34 1242 ■

Design: John Pawson



Lifting/sliding door handles with 180° click-stop mechanism, turnably fixed, concealed fixing, square spindle 10 mm

... 01100 (oval)
 ... 02100 (angular)
 – No keyway
 – M6 threaded lugs
 – For back-to-back fixing with variant 01102 (oval) or variant 02102 (angular)

... 01101 (oval)
 ... 02101 (angular)
 – PC keyway
 – M6 threaded lugs
 – For back-to-back fixing with variant 01103 (oval) or variant 02103 (angular)

... 01102 (oval)
 ... 02102 (angular)
 – No keyway
 – M6 × 80 mm screws
 – For back-to-back fixing with 42 4215 (oval), variant 01100 or variant 02100

... 01103 (oval)
 ... 02103 (angular)
 – PC keyway
 – M6 × 80 mm screws
 – For back-to-back fixing with 42 4215 (oval), variant 01101 or variant 02101

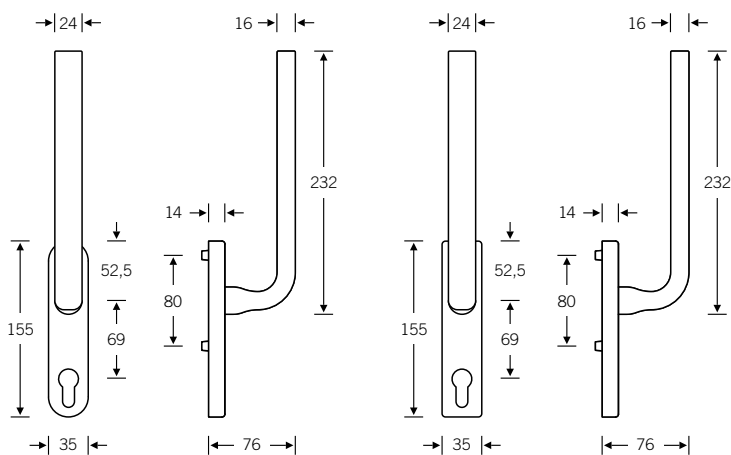



For matching FSB 42 4215 and 42 4217 recessed handles, see page 449 f.

Fittings for windows

Recessed handles for lifting/sliding door fittings



- Aluminium
- Stainless steel
- Bronze

42 4215  

42 4215 00000 (no keyway)
42 4215 00002 (PC keyway)
Recessed handles for back-to-back fixing

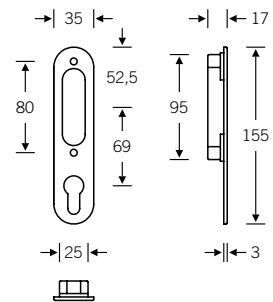
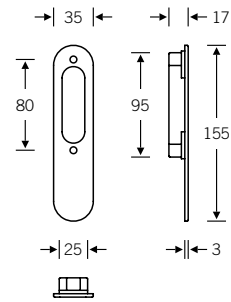
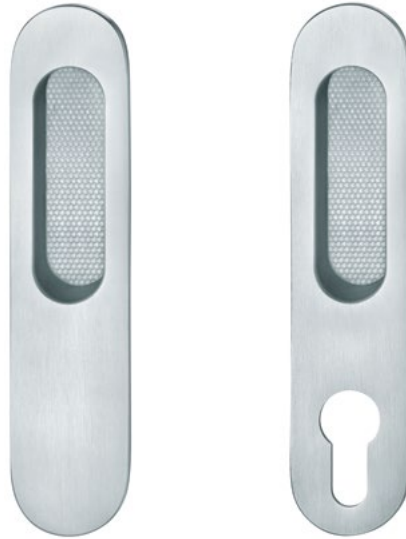
M6 threaded screws



42 4215   

42 4215 01000
Recessed handle for back-to-back fixing

M6 threaded screws

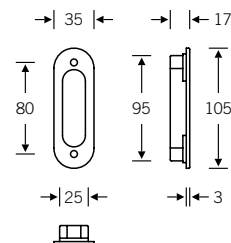

6b

Fittings for windows

Recessed handles for lifting/sliding door fittings

- Aluminium
- Stainless steel
- Bronze

42 4217



42 4217 00000 (no keyway)
 42 4217 00002 (PC keyway)
 Recessed handles for back-to-back fixing

M6 threaded screws

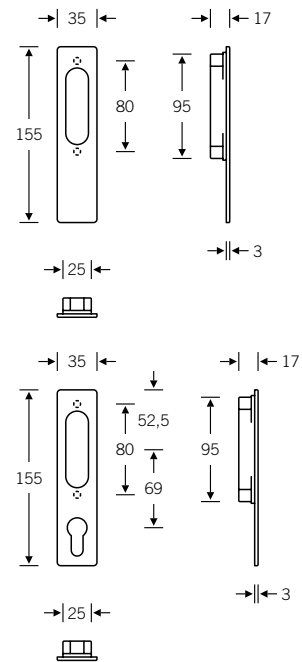

42 4217



42 4217 01000
 Recessed handle for back-to-back fixing

M6 threaded screws

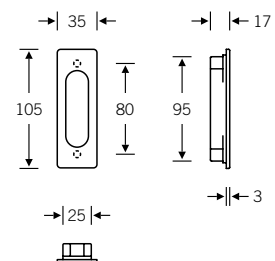

453 **Technical information**
Fittings for windows

Technical information

Fittings for windows conforming to EN 13126-3

The engineering behind our window handles centres around the click-stop mechanism, which is a particularly rugged fusion of components in tempered steel, stainless steel and GFR plastic that is further enhanced by its compact design and ideal installation process.

FSB's fine new hardware is engineered to deliver 25,000 operations or 150,000 click-stop events (180° turn/tilt cycles), earning it the highest durability rating of 5/180.

EN 13126 specifies the test requirements for windows in terms of their durability, strength, security and functionality. Part 3 of this standard defines requirements for window handles that serve to ensure unchanging quality and fitness for purpose over a great many years. The test results produce a classification code composed of grades from nine categories, also known as 'digits'.

Classification code

FSB window handles/plug-in handles with click-stop mechanism

| | | | | | | | | |
|---|-------|---|---|---|----|-----|------|---|
| 2 | 5/180 | - | 0 | 1 | 3* | 0/0 | 3/C1 | - |
|---|-------|---|---|---|----|-----|------|---|

* Bronze grade 0

FSB window handles with lock cylinder

| | | | | | | | | |
|---|-------|---|---|---|----|-----|------|---|
| 2 | 5/180 | - | 0 | 1 | 3* | 3/3 | 3/C1 | - |
|---|-------|---|---|---|----|-----|------|---|

* Bronze grade 0

FSB plug-in handles with lock cylinder

| | | | | | | | | |
|---|-------|---|---|---|----|-----|------|---|
| 2 | 5/180 | - | 0 | 1 | 3* | 2/3 | 3/C1 | - |
|---|-------|---|---|---|----|-----|------|---|

* Bronze grade 0

FSB window handles with push-button

| | | | | | | | | |
|---|-------|---|---|---|----|-----|------|---|
| 2 | 5/180 | - | 0 | 1 | 3* | 3/1 | 3/C1 | - |
|---|-------|---|---|---|----|-----|------|---|

* Bronze grade 0

FSB plug-in handles with push-button

| | | | | | | | | |
|---|-------|---|---|---|----|-----|------|---|
| 2 | 5/180 | - | 0 | 1 | 3* | 2/1 | 3/C1 | - |
|---|-------|---|---|---|----|-----|------|---|

* Bronze grade 0

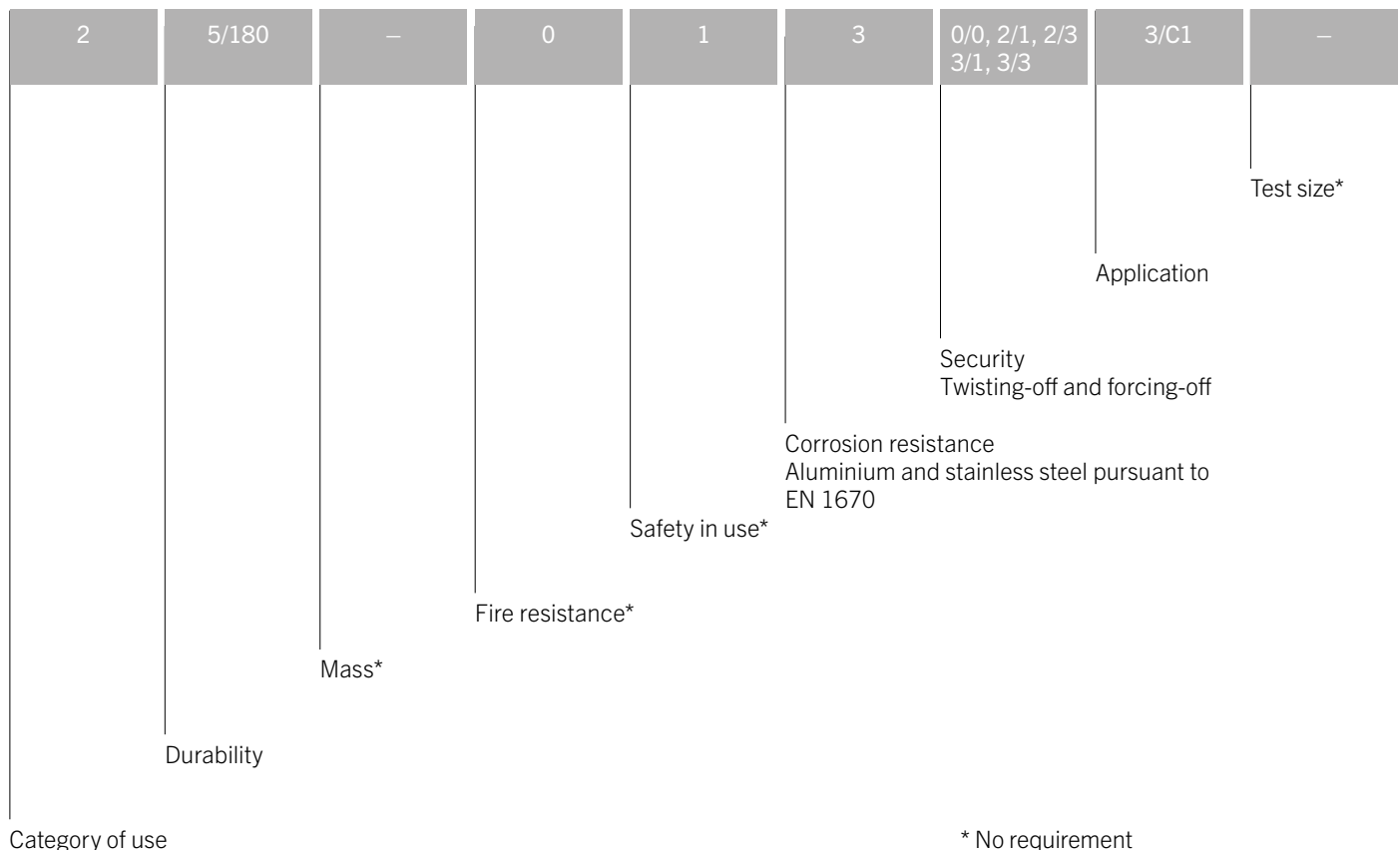

Technical information

Fittings for windows conforming to EN 13126-3

1. Category of use

There are two grades for the first digit of the classification code (category of use), which take different quality levels in Europe into account. The higher-quality grade 2 reflects the known, tried-and-tested product features of previous RAL window handles.

The overview on the right shows the test components of the category of use and a comparison of FSB product features with the requirements for grades 1 and 2.

Click torques

M_0 = between-clicks torque (the torque between two click-stop events)

M_a = click-out torque

M_d = differential value before and after durability test

| Grade | M_0 | M_a | M_d |
|------------|---------------------------|---------------------------|---------------------------|
| Grade 1 | $M_0 \leq 1.4 \text{ Nm}$ | $M_a \leq 6.0 \text{ Nm}$ | $M_d \geq 0.4 \text{ Nm}$ |
| Grade 2 | $M_0 \leq 0.8 \text{ Nm}$ | $M_a \leq 4.0 \text{ Nm}$ | $M_d \geq 0.8 \text{ Nm}$ |
| FSB | $M_0 \leq 0.2 \text{ Nm}$ | $M_a \leq 1.5 \text{ Nm}$ | $M_d \geq 0.8 \text{ Nm}$ |

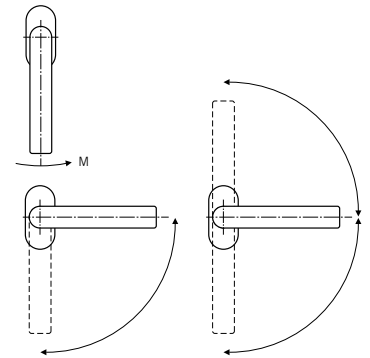

Free play at a right angle and parallel to the fixing plane

FSB fittings ensure a secure hold and do not allow any space for sets to wobble.

| Grade | Δ |
|------------|-------------------------------|
| Grade 1 | $\Delta \leq 6 \text{ mm}$ |
| Grade 2 | $\Delta \leq 4 \text{ mm}$ |
| FSB | $\Delta \leq 0.15 \text{ mm}$ |

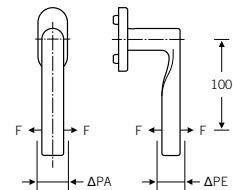

Torsional strength 200 N / 85 mm / 30 s

Refers to the resistance of the unlocked window handle against twisting-off

| Grade | Δ |
|------------|----------------------------|
| Grade 1 | $\Delta \leq 5 \text{ mm}$ |
| Grade 2 | $\Delta \leq 2 \text{ mm}$ |
| FSB | $\Delta \leq 1 \text{ mm}$ |

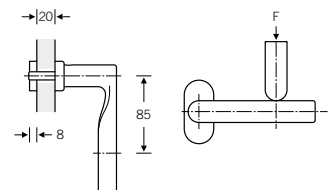

Tensile strength of the spindle connection

Compactly designed connection elements ensure high tensile strength.

| Grade | F |
|------------|------------------------|
| Grade 1 | $F \geq 100 \text{ N}$ |
| Grade 2 | $F \geq 100 \text{ N}$ |
| FSB | $F \geq 115 \text{ N}$ |

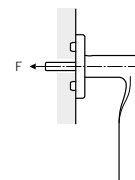

Eccentric tensile strength

FSB fittings can withstand eccentric forces and do not break.

| Grade | F |
|------------|-----------------------|
| Grade 1 | $F = 600 \text{ N}$ |
| Grade 2 | $F = 1,200 \text{ N}$ |
| FSB | $F = 1,200 \text{ N}$ |

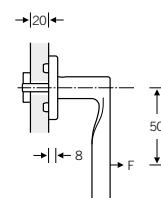

6b

Technical information

Fittings for windows conforming to EN 13126-3

2. Durability

FSB sets far exceed the requirements set for the fatigue test. The force and motion conditions likely to be experienced in the field are recreated on a test rig and simulated in a fatigue test.

| | |
|-------------|--------------------------------|
| Grade 3/90 | 10,000 turn-only cycles |
| Grade 4/90 | 15,000 turn-only cycles |
| Grade 5/90 | 25,000 turn-only cycles |
| Grade 3/180 | 10,000 turn/tilt cycles |
| Grade 4/180 | 15,000 turn/tilt cycles |
| Grade 5/180 | 25,000 turn/tilt cycles |
| FSB | 25,000 turn/tilt cycles |

3. Mass

No requirement in accordance with the main part of this standard, EN 13126-1

4. Fire resistance

No requirement in accordance with the main part of this standard, EN 13126-1

5. Safety

Grade 1 in accordance with the main part of this standard, EN 13126-1

6. Corrosion resistance

At least grade 2 as per EN 1670 in accordance with the main part of this standard, EN 13126-1

7. Security

Whether you need window handles without a locking mechanism or lockable variants with high resistance against forcing-off, FSB offers the right solutions for every requirement and application area; see next page.

| | |
|-------------|-------------------------------------------------------------------|
| Grade 0 | without security |
| Grade 1 | 35 Nm resistance against twisting-off and forcing-off |
| Grade 2 | 100 Nm resistance against twisting-off and forcing-off |
| Grade 3 | 200 Nm resistance against twisting-off and forcing-off |
| Extension 0 | no locking mechanism |
| Extension 1 | non-key-operated locking mechanism |
| Extension 2 | key-operated locking mechanism with ≤ 99 locking variations |
| Extension 3 | key-operated locking mechanism with ≥ 100 locking variations |

Technical information

Fittings for windows conforming to EN 13126-3

7. Security

Here you will find all of the possible permutations for the seventh digit:

| | |
|-----|-------------------------------------------------------------------------------------------------------------------------------------------------------------------------------------------|
| 0/0 | FSB window handles / FSB plug-in handles: without security / without locking mechanism |
| 1/1 | 35 Nm resistance against twisting-off and forcing-off / non-key-operated locking mechanism |
| 1/2 | 35 Nm resistance against twisting-off and forcing-off / key-operated locking mechanism with ≤ 99 locking variations |
| 1/2 | 35 Nm resistance against twisting-off and forcing-off / key-operated locking mechanism with minimum 100 locking variations |
| 2/1 | FSB plug-in handles with push-button: 100 Nm resistance against twisting-off and forcing-off / non-key-operated locking mechanism |
| 2/2 | 100 Nm resistance against twisting-off and forcing-off / key-operated locking mechanism with ≤ 99 locking variations |
| 2/3 | FSB lockable plug-in handles with lock cylinder: 100 Nm resistance against twisting-off and forcing-off / key-operated locking mechanism with minimum 100 locking variations |
| 3/1 | FSB window handles with push-button: 200 Nm resistance against twisting-off and forcing-off / non-key-operated locking mechanism |
| 3/2 | 200 Nm resistance against twisting-off and forcing-off / key-operated locking mechanism with ≤ 99 locking variations |
| 3/3 | FSB lockable window handles with lock cylinder: 200 Nm resistance against twisting-off and forcing-off / key-operated locking mechanism with minimum 100 locking variations |

6b

8. Application

Applicable part of this EN standard, grade 3:

| | |
|----------------------------|---------------|
| Application N | non-clickable |
| Application C (FSB) | clickable |
| Type 1 (FSB) | window handle |
| Type 2 | geared handle |

Here you will find all of the possible permutations for the eighth digit:

| | |
|-------------------|------------------------------------|
| 3/N1 | Part 3/non-clickable/window handle |
| 3/N2 | Part 3/non-clickable/geared handle |
| 3/C1 (FSB) | Part 3/clickable/window handle |
| 3/C2 | Part 3/clickable/geared handle |

Technical information

Fixing system for flush-fitted window handles

Flush-fitted window handles

A number of FSB window handles are also available as flush-fitted variants. Please note that CNC machining is required for flush-fitted solutions.

34 09034 (oval rose)

34 09036 (angular rose)

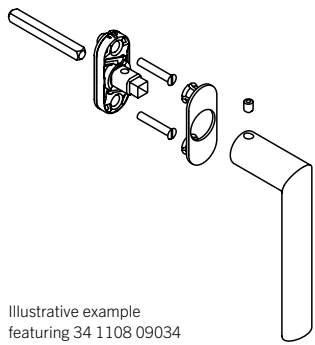

Illustrative example featuring 34 1108 09034

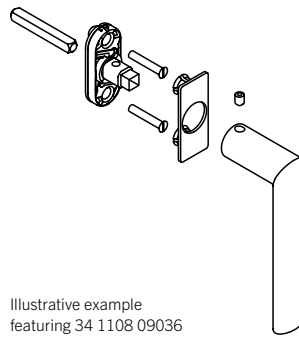

Illustrative example featuring 34 1108 09036

Routing dimensions:

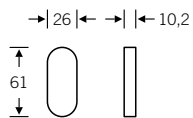

Routing dimensions:

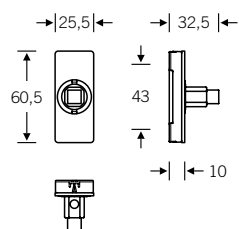
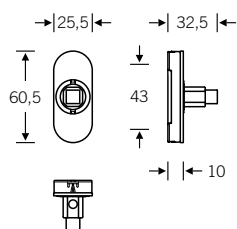
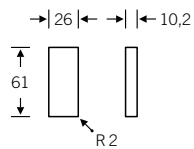

Technical information

Fixing system for plug-in handles for windows

Metal and PVC profiles

Please note that CNC machining is required for routing on metal and PVC profiles. Precision CNC routing details can be found at www.fsb.de/cnc

The required drill hole layout for plug-in handles needs to be in keeping with the window profile selected (see drawing). Further details and information about routing and installation can be found in the installation instructions:

For PVC profiles:
6 79 8430 00701

For metal profiles:
6 79 8430 00570
6 79 8430 00680 (lockable plug-in handles)

Models equipped with a lock cylinder can also be used on burglary-resistant windows.

The following models are available as lockable variants with 100 Nm resistance against twisting-off and forcing-off: 1001, 1076, 1078, 1093, 1108, 1144, 1244. The 'tilt-to-turn' function is not available.

Plug-in handles for metal profiles

34 711..

Variable spindle projection:
...00 (16–24 mm)
...01 (24–38 mm)
...02 (38–53 mm)

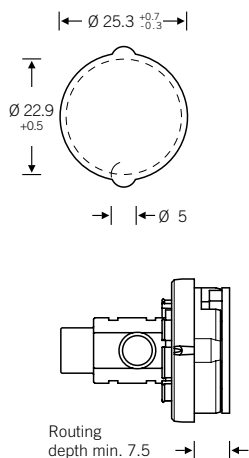
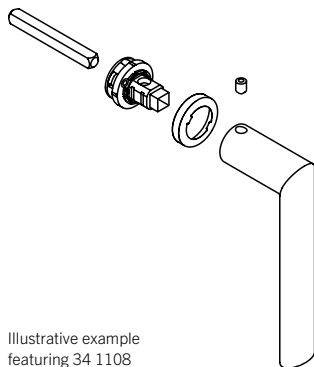

Lockable plug-in handles for metal profiles

34 71...

Variable spindle projection:
... 423 (29–34 mm)
... 424 (34–39 mm)
... 723 (push-button 29–34 mm)
... 724 (push-button 34–39 mm)

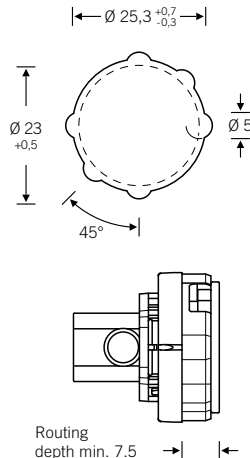
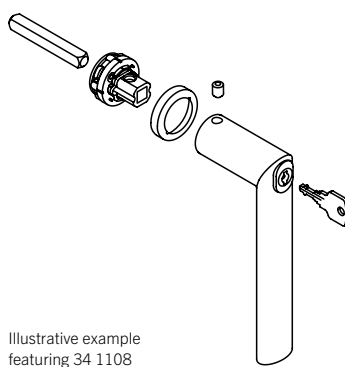

Plug-in handles for PVC profiles

34 751..

Variable spindle projection:
...00 (16–24 mm)
...01 (24–38 mm)
...02 (38–53 mm)

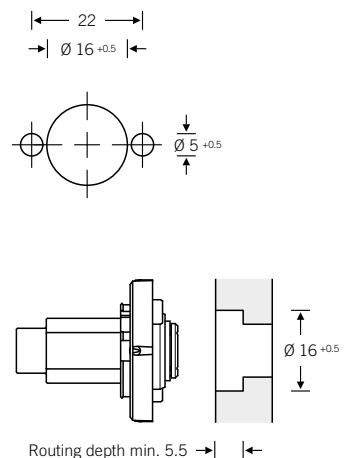
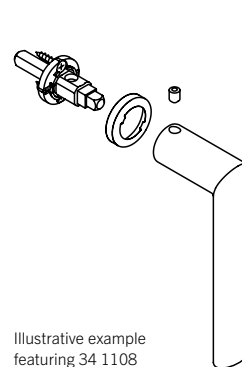

6b

Technical information

Fixing system for plug-in handles for windows

Plug-in handles for timber profiles

Please note that CNC machining is an option for preparing timber profiles for FSB plug-in handle solutions. Precision CNC routing details can be found at www.fsb.de/cnc

Alternatively, you can use the correct FSB routing jig 03 0462 00040, which must be ordered separately.

The required drill hole layout for plug-in handles needs to be in keeping with the window profile selected (see drawing).

Further details and information about routing and installation can be found in the installation instructions 6 79 8430 00689 0000.

Plug-in handles for timber profiles

34 ... 711.. with fixing accessories
03 0401 00003 0400

Variable spindle projection:

...00 (16–24 mm)

...01 (24–38 mm)

...02 (38–53 mm)

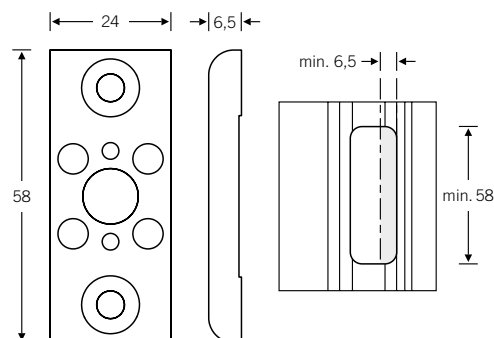
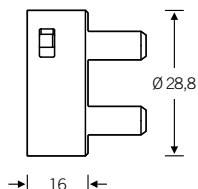
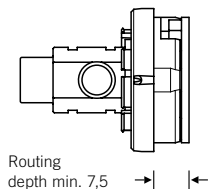
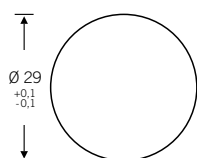
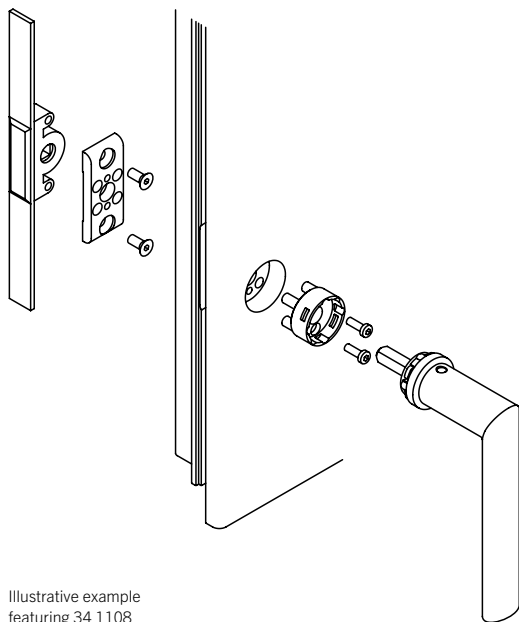

Technical information

Fixing system for plug-in handles for windows

Models equipped with a lock cylinder can also be used on burglary-resistant windows. The following models are available as lockable variants with 100 Nm resistance against twisting-off and forcing-off: 1001, 1076, 1078, 1093, 1108, 1144, 1244. The 'tilt-to-turn' function is not available.

Lockable plug-in handles for timber profiles

34 ... 71... with fixing accessories
03 0401 00003 0400

Variable spindle projection:

- ... 423 (29–34 mm)
- ... 424 (34–39 mm)
- ... 723 (push-button 29–34 mm)
- ... 724 (push-button 34–39 mm)

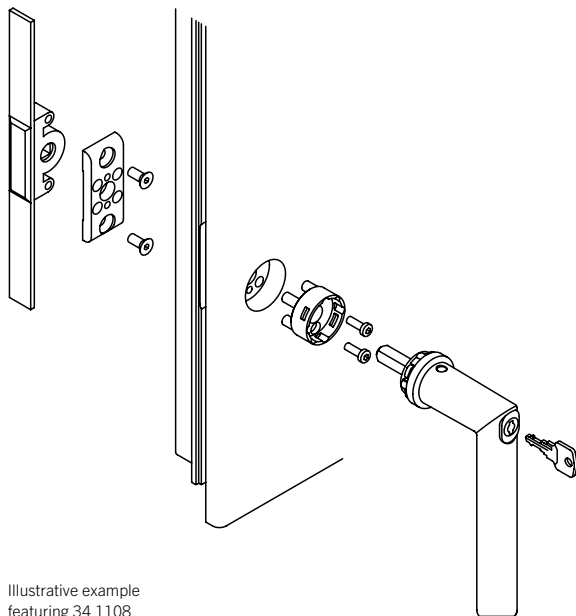

Illustrative example featuring 34 1108

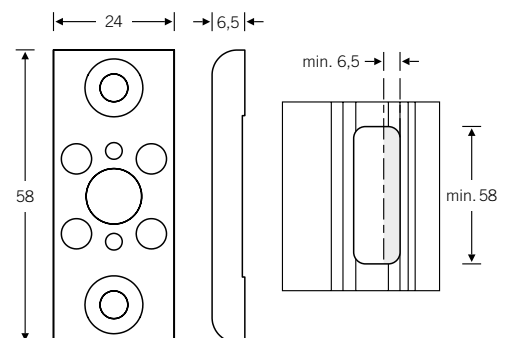
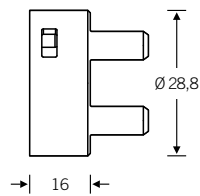
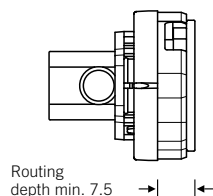
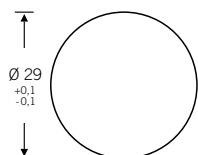

6b



- 462 Fittings for narrow-stile doors
- 476 Lever handles
- 479 Doorknobs
- 485 Slide-on and adhesive roses
- 486 Lever/lever and lever/knob sets
- 489 Technical information

Fittings for narrow-stile doors

Added value at a glance

With its product collections, FSB ensures continuity of the selected design across all door and window fittings. Naturally this also includes fittings for narrow-stile doors with metal or PVC profiles. The fixing material supplied is adapted to meet the special

requirements of narrow-stile doors and their fittings. Standard and heavy-duty variants as well as inactive-leaf sets are regularly designed for face fixing. Through-fixing is possible in combination with certain narrow-stile door locks; see page 495.

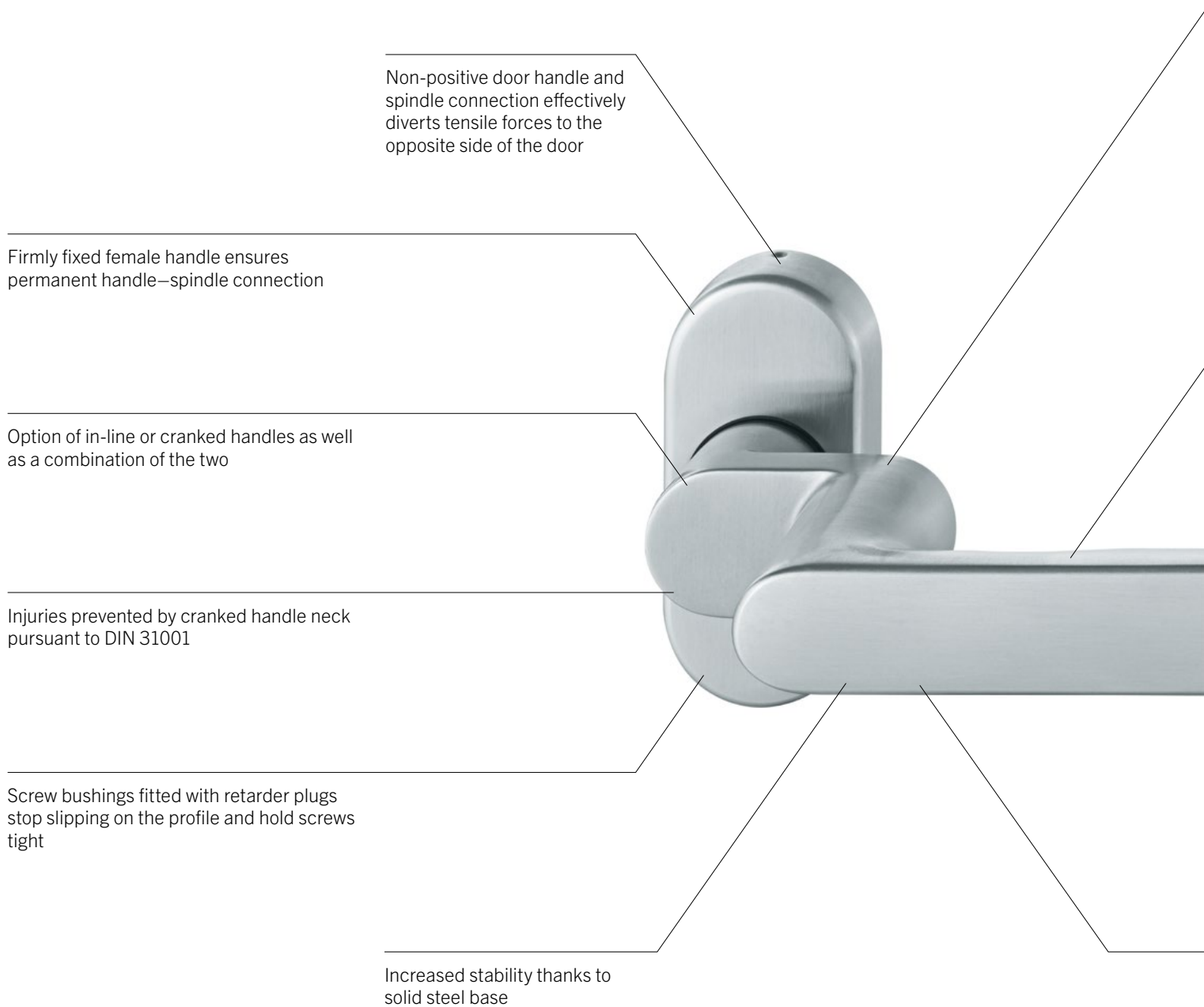

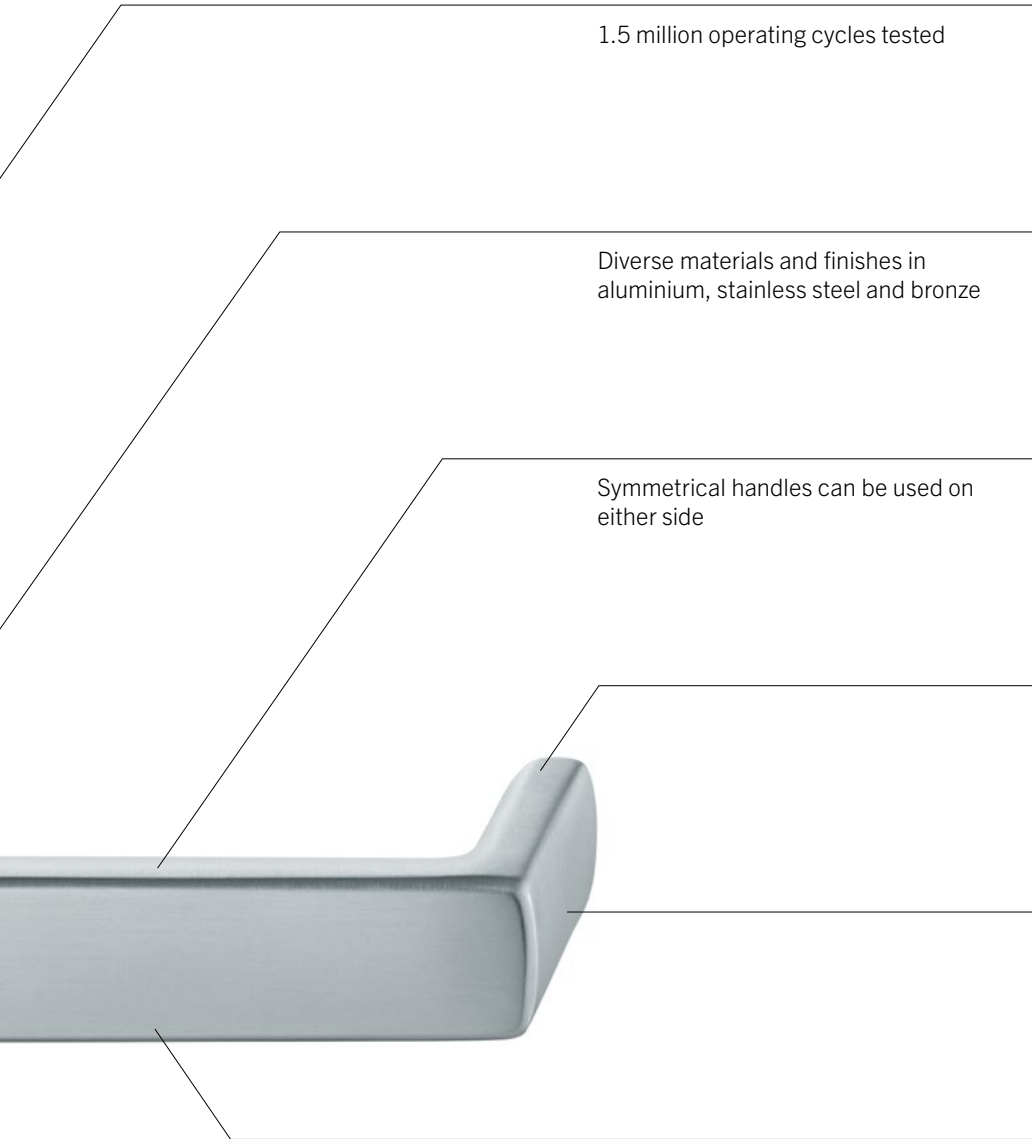

1.5 million operating cycles tested

Diverse materials and finishes in aluminium, stainless steel and bronze

Symmetrical handles can be used on either side

Positive mechanism allows for a maximum operating angle of 45° so narrow-stile door handles do not sag

Option of narrow-stile door handles with and without return-to-door (EN 179 compatible)

Over 70 different narrow-stile door handle models and over 50 models for emergency exit devices conforming to EN 179

Roses alternatively available as angular variants

Narrow-stile door handles meeting the requirements of the German Social Accident Insurance (DGUV) for injury prevention are available

Fittings for narrow-stile doors

Product variants

Product features of lever handles for narrow-stile doors

- Suitable for use on fire doors and escape-route doors
- Concealed face fixing
- Oval or angular rose
- Integrated positive mechanism
- Max. operating angle of 45° for active leaf
- Turnably fixed plain bearing
- For single and double-leaf narrow-stile doors

Cranked lever handles for narrow-stile doors



Oval rose:

☞ 06 011 (spindle 8 mm)

☞ 06 012 (spindle 9 mm)

Angular rose:

☞ 06 071 (spindle 8 mm)

☞ 06 072 (spindle 9 mm)

Oval rose:

☞ 06 012 (spindle 9 mm)

Angular rose:

☞ 06 072 (spindle 9 mm)

To enable fittings to be securely fixed onto the narrow stiles yet prevent hands from getting caught between the closing face and the door jamb, a cranked handle is used on the closing face and connected to a non-cranked male handle on the opening face. This inspired combination was the brainchild of philosopher Ludwig Wittgenstein and it both prevents hand injury and solves fixing problems. (Injury prevention in accordance with DIN 31001)

A perfectly matched lever handle for narrow-stile doors ideally becomes the jewel in the crown of every product collection. This is certainly true for the FSB 1272 and FSB 1286 models, for example. The cranking in these models is confined to a slight adjustment of the transition radius between the handle neck and the grip section. The basic design of the standard lever handle collection is thus systematically extended to narrow-stile doors – while simultaneously taking into account the specific requirements and standards governing these doors.

Safety clearance

The spatial restrictions associated with narrow-stile doors mean there is a risk of hands getting caught between the closing face and the door jamb when operating the door (see figure). DIN 31001 stipulates a clearance of 25 mm between the lever handle and the closing edge. Detailed information on safety clearances can be found in DIN 31001.

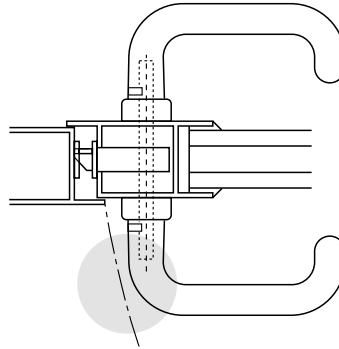

In-line lever handles for narrow-stile doors



Oval rose:

☞ 09 111 (spindle 8 mm)

☞ 09 112 (spindle 9 mm)

Angular rose:

☞ 09 171 (spindle 8 mm)

☞ 09 172 (spindle 9 mm)

Oval rose:

☞ 09 112 (spindle 9 mm)

Angular rose:

☞ 09 172 (spindle 9 mm)

Depending on the lock backset and the width of the door profile, the in-line lever handle is ideally combined with a cranked lever handle for narrow-stile doors. Two in-line lever handles for narrow-stile doors can also be combined.

Fittings for narrow-stile doors

Product variants

Product features of inactive-leaf sets

- Suitable for heavy-duty applications
- Available in-line and cranked
- For double-leaf narrow-stile doors
- Active leaf is for used for access; inactive leaf is only opened as needed
- Fixing material is supplied
- Oval or angular rose

Non-spring-assisted espagnolette locks with operating angles $< 45^\circ$ are to be used in combination with narrow-stile door handles fitted with a positive mechanism. If the operating angle is $> 45^\circ$ and models are simultaneously used as inactive-leaf sets (i.e. without positive mechanism), spring-assisted locks are generally called for in the case of bronze variants and the following stainless steel models:

- 06 1163 ...
- 06 1164 ...
- 06 1243 ...

In-line lever handle for narrow-stile doors as inactive-leaf set (ILS)



- 🔩 09 112 (oval, spindle 9 mm)
- 🔩 09 172 (angular, spindle 9 mm)

Positive mechanism must be disabled in order to modify the set for the in-line lever handle for narrow-stile doors.

Notes on this can be found in the associated installation instructions.

Cranked lever handle for narrow-stile doors as inactive-leaf set (ILS)



- 🔩 06 023 (oval, inactive leaf)
- 🔩 06 073 (angular, inactive leaf)

Cranked lever handle for narrow-stile doors without positive mechanism

Product features of lever handles for narrow-stile doors

- For doors with low requirements, e.g. garden gates or side entrances
- Visible face fixing
- Angular rose
- For single-leaf narrow-stile doors

Lever handles for narrow-stile doors with visible fixing



06 0605 013
09 1087 002



06 0620 016
06 0663 016

With positive mechanism

Fittings for narrow-stile doors

Overview

Lever handles in the FSB product collections

06 1001 ■
09 1001 ■
Page 82



06 1002 ■
09 1002 ■
Page 82



09 1004 ■ ■ ■
Page 92



09 1005 ■ ■ ■
Page 98



06 1015 ■ ■ ■ ■
09 1015 ■ ■ ■ ■
Page 104



06 1016 ■ ■ ■ ■
09 1016 ■ ■ ■ ■
Page 110



06 1023 ■ ■ ■ ■
09 1023 ■ ■ ■ ■
Page 120



06 1031 ■ ■ ■ ■
09 1031 ■ ■ ■ ■
Page 126



06 1035 ■ ■ ■ ■
09 1035 ■ ■ ■ ■
Page 126



06 1043 ■ ■ ■ ■
09 1043 ■ ■ ■ ■
Page 180



06 1045 ■ ■ ■ ■
09 1045 ■ ■ ■ ■
Page 132



06 1053 ■ ■ ■ ■
09 1053 ■ ■ ■ ■
Page 120



06 1070 ■ ■
 09 1070 ■ ■
 Page 146



06 0644 ■ ■
 09 1074 ■ ■
 Page 248



06 1076 ■ ■
 09 1076 ■ ■ ■
 Page 165



06 1078 ■ ■
 09 1078 ■ ■
 Page 162



06 1088 ■ ■
 09 1088 ■ ■
 Page 162



06 1093 ■ ■
 09 1093 ■ ■
 Page 168



06 1094 ■ ■
 09 1094 ■ ■
 Page 168



09 1102 ■ ■ ■
 Page 174



09 1106 ■ ■ ■
 Page 180



06 1107 ■ ■
 09 1107 ■ ■
 Page 186



06 1108 ■ ■
 09 1108 ■ ■
 Page 192



06 1119 ■ ■
 09 1119 ■ ■
 Page 198



06 1134 ■ ■ ■
 09 1134 ■ ■ ■
 Page 92



06 1144 ■ ■
 09 1144 ■ ■
 Page 208



06 1146 ■ ■
 09 1146 ■ ■
 Page 214





09 1147 ■ ■
 Page 220





6c

Fittings for narrow-stile doors



Overview

06 1159 
09 1159 
Page 226





06 1160 
09 1160 
Page 232





06 1163 
09 1163 
Page 238





06 1164 
09 1164 
Page 238



06 1177 
09 1177 
Page 186



06 1178 
09 1178 
Page 192





09 1183 
Page 248





06 1232 
09 1232 
Page 258



06 1243 
09 1243 
Page 268





06 1245 
09 1245 
Page 274





06 1247 
09 1247 
Page 280



06 1255 
09 1255 
Page 290





06 1268 
09 1268 
Page 296



06 1272 
Page 302



06 1286 
09 1286 
Page 308



Backplates and roses

Individual parts

14 1596 ■ ■
Page 366



09 0001 ■ ■
Page 366



17 1758 ■ ■ ■
17 1788 ■ ■ ■
Page 367



17 1757 ■ ■ ■
17 1778 ■ ■ ■
Page 367



14 1550 ■ ■
Page 366



17 1752 ■ ■
Page 367



17 1755 ■ ■
Page 367



6c

Fittings for narrow-stile doors

Overview

Lever handles

with concealed fixing

09 1150 ■
Page 476



06 0662 ■ ■
Page 476



Lever handles

with visible fixing

06 0605 ■
09 1087 ■
Page 477



06 0620 ■
06 0663 ■
Page 478



Doorknobs and thumb turn

with concealed fixing

07 0802 ■ ■
Page 479



07 0804 ■
Page 479



07 0809 ■ ■
Page 480



07 0812 ■ ■
Page 480



07 0829 ■ ■ ■
Page 481



07 0846 ■ ■ ■
Page 481



07 0854 ■
Page 482



03 0418 ■ ■ ■
Page 482



Doorknobs

with visible fixing

07 0829 ■
Page 483



07 0846 ■
Page 483



07 0846 ■
Page 484



Slide-on and adhesive roses

17 1765 ■ ■ ■
17 1766 ■ ■ ■
Page 485



17 1768 | 17 1769 ■ ■
17 1729 | 17 1730 ■ ■
Page 485



Lever/lever and lever/knob sets

06 7816 ■ ■
Page 486



06 7816 ■ ■
Page 487



6c

Fittings for narrow-stile doors

Lever handles with concealed fixing

- Aluminium
- Stainless steel
- Bronze

09 1150 ■

↻ 09 1150 011 (in-line)

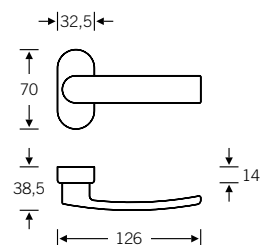

06 0662 ■ ■

↻ 06 0662 011 (cranked)
 ↻ 06 0662 012 (cranked)
 ↻ 06 0662 023 (cranked, inactive leaf)

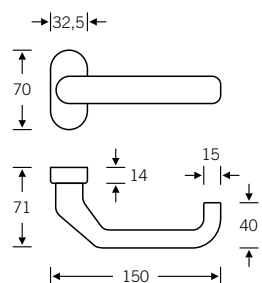

For SSF locks for narrow-stile doors with through-fixing option, see page 495

↻ FSB ASL®
 ↻ FSB AGL®
 ↻ FS heavy-duty fitting
 ↻ EN 179 heavy-duty fitting
 For bearings, see page 52 ff.

Fittings for narrow-stile doors

Lever handles with visible fixing

- Aluminium
- Stainless steel
- Bronze

06 0605 ■

06 0605 013 (cranked)

Without positive mechanism

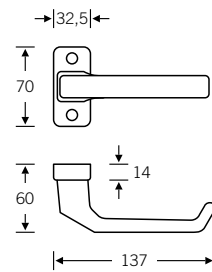

09 1087 ■

09 1087 002

Without positive mechanism

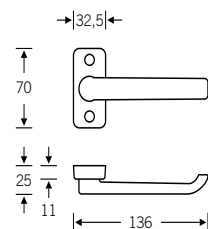

6c

Fittings for narrow-stile doors

Lever handles with visible fixing

- Aluminium
- Stainless steel
- Bronze

06 0620 ■

06 0620 016 (cranked)

With positive mechanism

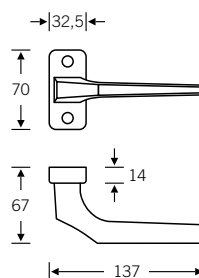

06 0663 ■

06 0663 016 (cranked)

With positive mechanism

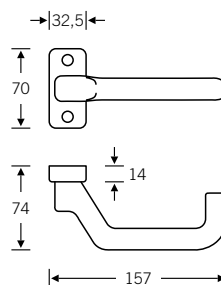

Fittings for narrow-stile doors

Doorknobs with concealed fixing

■ Aluminium
■ Stainless steel
■ Bronze

07 0802 ■ ■



- 07 0802 128 (turnably fixed)
aluminium, stainless steel
- 07 0802 228 (fixed)
aluminium, stainless steel
- 07 0802 228 (fixed)
stainless steel
- 07 0802 428 (fixed)
aluminium

Aluminium X = 85 mm
Stainless steel X = 81 mm

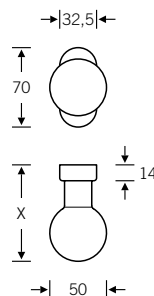

07 0804 ■



- 07 0804 228 (fixed)

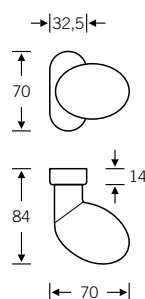

For SSF locks for narrow-stile doors with through-fixing option, see page 495

- FSB ASL®
 - FSB AGL®
 - FS heavy-duty fitting
 - EN 179 heavy-duty fitting
- For bearings, see page 52 ff.

6c



Fittings for narrow-stile doors

Doorknobs with concealed fixing

■ Aluminium
■ Stainless steel
■ Bronze

07 0809 ■ ■



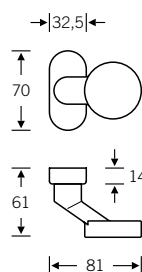

- 07 0809 128 (turnably fixed)
stainless steel
- 07 0809 228 (fixed)
aluminium, stainless steel
-  07 0809 228 (fixed)
stainless steel
-  07 0809 428 (fixed)
aluminium

Aluminium $\varnothing = 50$ mm
Stainless steel $\varnothing = 50$ mm







07 0812 ■ ■

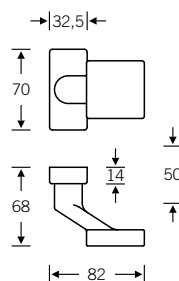

- 07 0812 229 (fixed)
aluminium, stainless steel
-  07 0812 229 (fixed)
stainless steel
-  07 0812 429 (fixed)
aluminium



For SSF locks for narrow-stile doors with through-fixing option, see page 495

-  FSB ASL®
 -  FSB AGL®
 -  FS heavy-duty fitting
 -  EN 179 heavy-duty fitting
- For bearings, see page 52 ff.

Fittings for narrow-stile doors

Doorknobs with concealed fixing

■ Aluminium
■ Stainless steel
■ Bronze

07 0829 ■ ■ ■



- 07 0829 228 (fixed)
aluminium, stainless steel, bronze
- 07 0829 228 (fixed)
stainless steel, bronze
- 07 0829 428 (fixed)
aluminium

Aluminium $\varnothing = 50$ mm
 Stainless steel $\varnothing = 55$ mm
 Bronze $\varnothing = 50$ mm

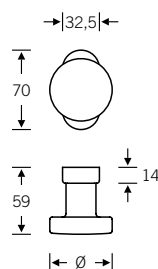

07 0846 ■ ■ ■



- 07 0846 128 (turnably fixed)
aluminium, stainless steel, bronze
- 07 0846 328 (turnably fixed)
aluminium, stainless steel, bronze
- 07 0846 228 (fixed)
aluminium, stainless steel, bronze
- 07 0846 228 (fixed)
stainless steel, bronze
- 07 0846 428 (fixed)
aluminium

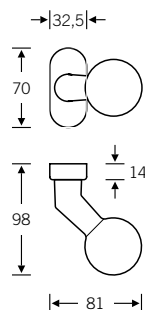

For SSF locks for narrow-stile doors with through-fixing option, see page 495

- FSB ASL®
 - FSB AGL®
 - FS heavy-duty fitting
 - EN 179 heavy-duty fitting
- For bearings, see page 52 ff.

6c

Fittings for narrow-stile doors

Doorknobs and thumb turn with concealed fixing

- Aluminium
- Stainless steel
- Bronze

07 0854 ■

07 0854 128 (turnably fixed)
 07 0854 228 (fixed)

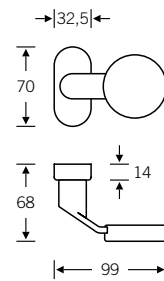

03 0418 ■ ■ ■

03 0418 003

Square spindle 8 mm
 Standard spindle projection 40 mm
 Custom spindle projections available

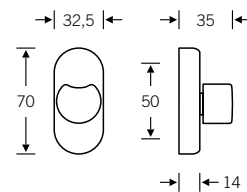

For SSF locks for narrow-stile doors with through-fixing option, see page 495

- ⊖ FSB ASL®
 - ⊖ FSB AGL®
 - ⊖ FS heavy-duty fitting
 - ⊖ EN 179 heavy-duty fitting
- For bearings, see page 52 ff.

Fittings for narrow-stile doors

Doorknobs with visible fixing

- Aluminium
- Stainless steel
- Bronze

07 0829 ■

07 0829 102 (turnably fixed)
07 0829 202 (fixed)

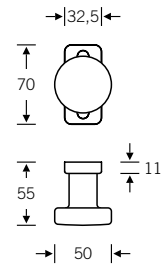

07 0846 ■

07 0846 102 (turnably fixed)
07 0846 202 (fixed)

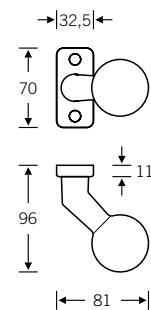

6c

Fittings for narrow-stile doors

Doorknobs with visible fixing

- Aluminium
- Stainless steel
- Bronze

07 0846 ■

07 0846 108 (turnably fixed)
07 0846 208 (fixed)

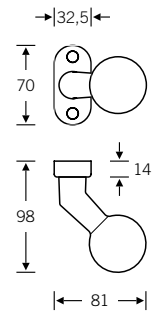

Fittings for narrow-stile doors

Slide-on and adhesive roses

- Aluminium
- Stainless steel
- Bronze

17 1765 

17 1765 000 (7 mm)
17 1765 001 (9 mm)

Slide-on rose

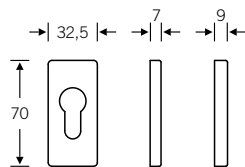

17 1766 

17 1766 000 (7 mm)
17 1766 001 (9 mm)

Slide-on rose

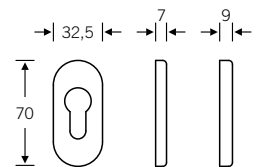

17 1768 | 17 1769 

17 1768 (3 mm)
17 1769 (7 mm)

Adhesive rose

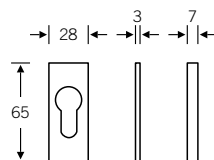

17 1729 | 17 1730 

17 1729 (3 mm)
17 1730 (7 mm)

Adhesive rose

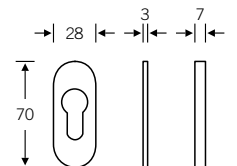

6c

Fittings for narrow-stile doors

Lever/lever set

- Aluminium
- Stainless steel
- Bronze

06 7816



Lever handle for narrow-stile doors on long oval backplate, with concealed fixing, operating angle 25° (does not apply to FS variant 06 7816 018)

Centres PC 72 mm + PC 92 mm

- ☞ 06 7816 001 (square spindle 8 mm and positive mechanism)
- ☞ 06 7816 018 (square spindle 9 mm for fire and smoke control narrow-stile doors, no positive mechanism)

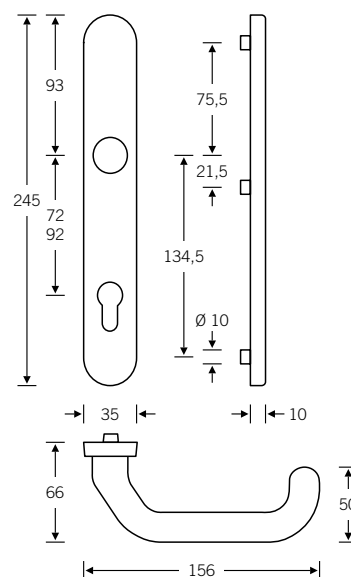

☞ 06 7816 001 | ☞ 06 7816 018
Lever/lever set

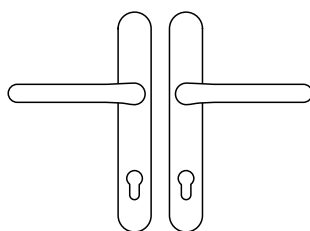

☞ 06 7816 05012 (right and left)
Half-set, no FS variant available

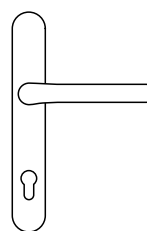

Order details required:

- Square spindle 8 or 9 mm
- Door thickness in mm
- Centres

- ☞ FSB ASL®
 - ☞ FSB AGL®
 - ☞ FS heavy-duty fitting
 - ☞ EN 179 heavy-duty fitting
- For bearings, see page 52 ff.

Fittings for narrow-stile doors

Lever/knob set

- Aluminium
- Stainless steel
- Bronze

06 7816



Lever handle for narrow-stile doors on long oval backplate, with concealed fixing, operating angle 25° (does not apply to FS variant 06 7816 019/20)

Centres PC 72 mm + PC 92 mm

- ☞ 06 7816 013
(square spindle 8 mm and positive mechanism)
- ☞ 06 7816 019 (R) | 06 7816 020 (L)
(square spindle 9 mm for fire and smoke control narrow-stile doors, no positive mechanism)

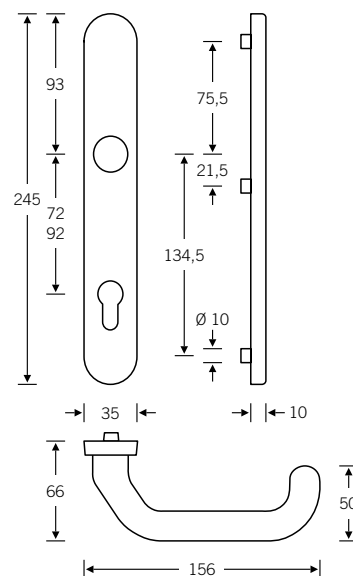

6c

☞ 06 7816 013
Knob-backplate set

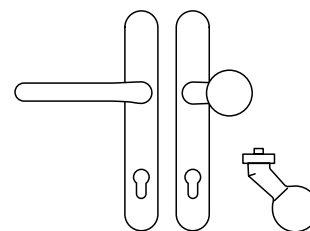

Order details required:

- Square spindle 8 or 9 mm
- Door thickness in mm
- Centres
- Handing (9 mm: fixed knob, 8 mm: loose knob)

- ☞ FSB ASL®
 - ☞ FSB AGL
 - ☞ FS heavy-duty fitting
 - ☞ EN 179 heavy-duty fitting
- For bearings, see page 52 ff.

489 **Technical information**
Fittings for narrow-stile doors

Technical information

Fittings for narrow-stile doors conforming to EN 1906

Our handles for narrow-stile doors come out on top, going far beyond the standard in many categories.

Standard EN 1906 defines the requirements and test methods for door handles and doorknobs. The practical value and classification of fittings must be judged across the entire eight-digit grading system. Certification under EN 1906 is only granted once all test criteria and the required results are met.

Perfection down to the last detail – our heavy-duty fittings pass with flying colours in each of the eight categories, also known as ‘digits’:

Classification code

For in-line and cranked lever handles for narrow-stile doors (on narrow rose) for 8 and 9 mm square spindle

| 4 | 7* | – | 0/D | 1 | 5 | 0 | A/U |
|----------------------------------|-----------------------------|--------------|---------------------------------------------------------------------------------------------------|-------------------------|-------------------------|---------------------------|---------------------------------|
| | | | | | | | 8. Type of operation A/B/U** |
| | | | | | | 7. Security Grades 0–4 | |
| | | | | | 6. Corrosion resistance | | |
| | | | | 5. Safety Grades 0/1 | | | |
| | | | 4. Fire resistance pursuant to EN 1906 Annex C, with 9 mm spindle in accordance with DIN 18273 | | | | |
| | | 3. Door mass | | | | | |
| | 2. Durability Grades 6/7 | | | | | | |
| 1. Category of use Grades 1–4 | | | | | | | |

* FSB: 1.5 million operating cycles tested
 ** A for standard and FS variant, U for FS inactive-leaf variant

Technical information

Fittings for narrow-stile doors conforming to EN 1906

1. Category of use

Grade 1

Doors with medium frequency of use by people with a high incentive to exercise care and a small chance of misuse, e.g. internal residential doors

Grade 2

Doors with medium frequency of use by people with some incentive to exercise care but where there is some chance of misuse, e.g. internal office doors

Grade 3

Doors with high frequency of use by the public or others with low incentive to exercise care and with a high chance of misuse, e.g. doors in public administrative buildings

Grade 4

Doors in public places with high frequency of use, which are subject to abuse or at risk of being damaged, e.g. doors in public toilets or schools, etc.

The fittings are tested on the following aspects in order to allocate the different grades to them:

- Rotational torque strength of the square spindle
- Tensile load
- Free play in neutral position
- Free angular movement

FSB is always in a class of its own: the figures and graphs to the right show just how well our lever handles for narrow-stile doors perform against the EN 1906 grading scheme.

Rotational torque strength of the square spindle

The FSB spindle offers greater rotational torque strength with less deformation.

| | |
|------------|---------------------------------|
| Grade 1 | M = 20 Nm |
| Grade 2 | M = 30 Nm |
| Grade 3 | M = 40 Nm |
| Grade 4 | M = 60 Nm |
| FSB | FSB spindle 8 mm = 60 Nm |
| | FSB spindle 9 mm = 60 Nm |

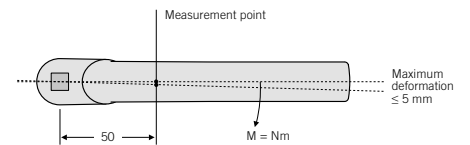

Tensile load

The compact design and durability of the connection elements guarantee the ability to withstand a higher tensile load.

| | |
|------------|------------------------------------------------|
| Grade 1 | F = 300 N |
| Grade 2 | F = 500 N |
| Grade 3 | F = 800 N |
| Grade 4 | F = 1,000 N |
| FSB | FSB narrow-stile door handles = 1,000 N |

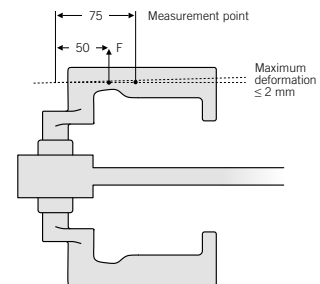

Free play in neutral position

FSB bearing technology ensures a secure hold and does not allow sets to wobble, with a guide bearing depth of 7 mm and handle guide diameter of 18 mm.

| | |
|------------|--------------------|
| Grade 1 | 10 mm |
| Grade 2 | 10 mm |
| Grade 3 | 6 mm |
| Grade 4 | 6 mm |
| FSB | < 0.5 mm |

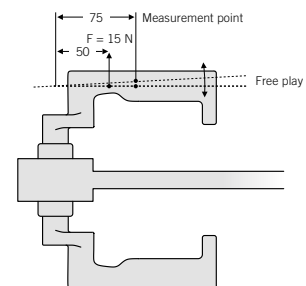

Free angular movement

Thanks to no-play tensioning, the FSB spindle prevents door handles from wobbling.

| | |
|------------|--------------------|
| Grade 1 | 10 mm |
| Grade 2 | 10 mm |
| Grade 3 | 5 mm |
| Grade 4 | 5 mm |
| FSB | < 0.5 mm |

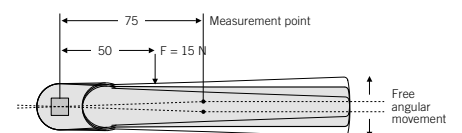

6c

Technical information

Fittings for narrow-stile doors conforming to EN 1906

2. Durability

FSB sets far exceed the requirements set for the fatigue test. The force and motion conditions likely to be experienced in the field are recreated on a test rig and simulated in a fatigue test.

| | |
|------------|-------------------------------------------|
| Grade 6 | 100,000 operational cycles for medium use |
| Grade 7 | 200,000 operational cycles for high use |
| FSB | 1,500,000 operating cycles tested |

3. Door mass

No requirement. This digit describes the door weight.

4. Fire resistance

FSB lever handles for narrow-stile doors with 9 mm square spindles in the fire safety variant have been tested and certified under DIN 18273.

5. Safety

To be assigned grade 1 here, fittings must be able to withstand loads of 1,500 N or 2,500 N depending on the category of use.

Lever handles for narrow-stile doors with 8 and 9 mm square spindles meet the increased safety requirements as they can withstand tensile forces of 2,500 N, making them wholly suitable for use in public buildings.

Grade 0 = normal use
Grade 1 = safety application
Grade 1–4 category of use
(first digit of the classification code)

| | |
|------------|-----------------------------------------------|
| Grade 1 | F = 1,500 N |
| Grade 2 | F = 1,500 N |
| Grade 3 | F = 2,500 N |
| Grade 4 | F = 2,500 N |
| FSB | FSB narrow-stile door handles = 2500 N |

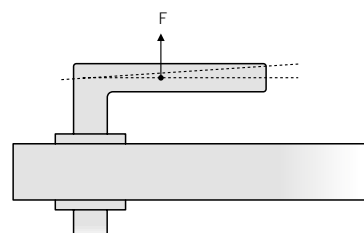

6. Corrosion resistance

This digit describes the defined corrosion resistance. FSB narrow-stile door fittings made of aluminium and stainless steel meet the requirements of grade 5 set out in EN 1906, which is verified with a 480-hour salt spray test.

Grade 0 = no defined corrosion resistance
Grade 1 = mild resistance
Grade 2 = moderate resistance
Grade 3 = high resistance
Grade 4 = very high resistance
Grade 5 = extra high resistance

7. Security

Where 'burglary-resistant fittings' are concerned, FSB offers a special range of fittings for security grades 2 and 4 in many different designs. Naturally our security fittings also meet the other requirements of this standard.

Grade 0 = no burglary resistance
Grade 1 = mild resistance
Grade 2 = moderate resistance
Grade 3 = high resistance
Grade 4 = extra high resistance

8. Type of operation

FSB lever handles for narrow-stile doors are equipped with a type A positive mechanism in the standard and FS variant. Inactive-leaf variants are unsprung (type U).

A = spring-assisted
B = spring-loaded
U = unsprung

Technical information

Fixing system for narrow-stile doors

Application-specific FSB fixing accessories and spindles for narrow-stile door handles

It is usual for narrow-stile door sets to be put together from individual components to suit differing applications. FSB caters to this with a versatile, needs-based spindle concept. The FSB spindles presented on the following page are designed for specific applications.

Our in-house sales team or FSB Applications Engineering department will be pleased to help you with the precise specification for your order with regard to your particular application and door thickness.

Fixing accessories included in the scope of delivery

- M5 non-loosening screws
- Base with integrated anti-slip/screw-retention devices
- Rivet nuts matched to the base (head \varnothing 11 mm); standard assembly tool required to insert blind rivet nuts

FSB cannot accept complaints caused by a failure to use FSB fixing accessories.

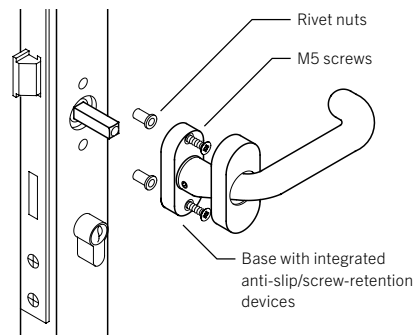

Anti-slip/screw-retention devices

The combination of rivet nuts, base and screws ensures that hardware can be fitted so as not to work loose. All FSB roses for narrow-stile door fittings have screw bushings fitted with rubbery plastic retarder plugs. These plugs act as an anti-slip device against their host surface while also providing the necessary axial and radial tension to hold the screws tight.

Technical information

Spindles for narrow-stile doors

In-line and cranked lever handles for narrow-stile doors, concealed fixing

All FSB narrow-stile door handles with roses with concealed fixing feature front-end drill holes as standard. Loose/unstable floating spindles, which may be found on metal doors, are a 'no-go' at FSB. The fixed spindle connection ensures safety and no slippage of the fitting.

The following FSB recommendations apply to all of the combinations of narrow-stile door sets and half-sets shown on the right.

Spindles for medium and heavy-duty doors and high-traffic doors

Special spindle 05 0525 028.. (8 mm) or 05 0525 029.. (9 mm); see page 766

- Permanently non-positive connection: the male handle sits fast at the back of the handle recess, secured by a grub screw with a point that fits exactly into a corresponding hole in the spindle
- Fixed spindle: the axial forces arising when doors and handles are operated are transferred to the door profile
- Leverage potential in the forces arising is always compensated through the best possible reduction of assembly tolerances for all modules involved
- The female handle is firmly and reliably secured with a screw that goes directly into the square spindle

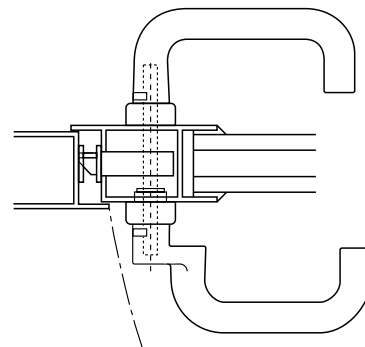
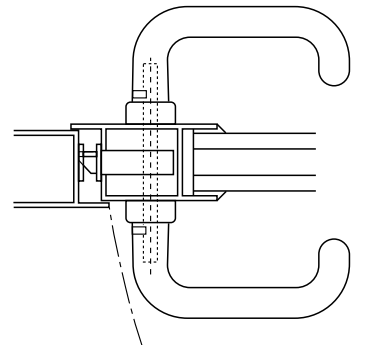
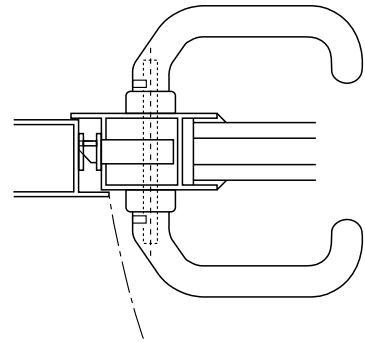

Spindles for light to medium heavy-duty doors

Full spindle 05 0118 008.. (8 mm) or 05 0118 019.. (9 mm); see page 758/760
The application-related spindle variants for all other FSB narrow-stile door fitting combinations can be found starting on page 758 ff.

Spindles for FS heavy-duty doors and emergency exit devices

To combine two narrow-stile door handles for emergency exit devices pursuant to EN 179 or for fire doors with panic locks: FSB special spindle 05 0125, see page 768.

Standard variant, visible fixing

Spindles to combine two cranked lever handles for narrow-stile doors (06 + 06)

Full spindles 05 0118 008.. (8 mm); see page 758

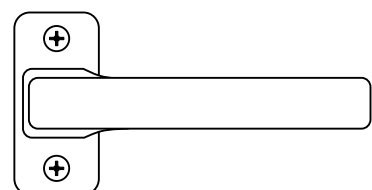

Technical information

Locks for narrow-stile doors

Through-fixing of lock and fitting for heavy-duty doors and especially high stability

- Chip-guarded through-fixing holes for side-to-side and hence optimum fastening of the narrow-stile door
- Self-tightening follower
- Non-handed latch bolt
- Galvanised lock case, enclosed at top and bottom, through-fixing holes chip-guarded
- High-comfort thanks to acoustically attenuated latch bolt (except in case of roller latch and dead-bolt locks)
- No rivet nuts because metal stabiliser lugs are recessed on both sides of the door profile
- Effective and significant reduction of installation time: due to through-fixing, the set only has to be installed with two more screws

SSF – Sächsische Schlossfabrik GmbH
Am Pappelhain 10
04539 Groitzsch, Germany
Tel. +49 (0)34 2967 3300
www.ssf.de | info@ssf.de



Series 01 (bolt throw 15 mm)

- Mortice locks conforming to DIN 18251-2, grade 1



Series 02 (bolt throw 21 mm)

- Mortice locks conforming to DIN 18251-2, grade 3, with bolt throw 21 mm or as 34.5 mm hook bolt lock
- Panic mortice locks for single-leaf narrow-stile doors (APE, APB, APD)
- Roller latch locks conforming to DIN 18251-2, grade 3
- Latch locks conforming to DIN 18251-2, grade 3, in standard-length and short variants
- Dead-bolt locks conforming to DIN 18251-2, grade 3, in standard-length and short variants

Fixing system with through-fixing option

FSB has optionally adapted the fixing system for narrow-stile door fittings to suit SSF narrow-stile door locks with through-fixing points for series 01 and 02.

Associated fixing set:
05 0526 01 (see page 767)
Narrow-stile door fittings can be ordered with this accessory pre-fitted.

Associated spindle:
05 0525 028.. (8 mm) or
05 0525 029.. (9 mm);
see page 767



| Accessory bag | Screw length | Door thickness |
|---------------|--------------|----------------|
| 05 0526 01045 | 50 mm | 45 – 49 mm |
| 05 0526 01050 | 55 mm | 50 – 54 mm |
| 05 0526 01055 | 60 mm | 55 – 59 mm |
| 05 0526 01060 | 65 mm | 60 – 64 mm |
| 05 0526 01065 | 70 mm | 65 – 69 mm |
| 05 0526 01070 | 75 mm | 70 – 74 mm |
| 05 0526 01075 | 80 mm | 75 – 79 mm |
| 05 0526 01080 | 85 mm | 80 – 84 mm |
| 05 0526 01085 | 90 mm | 85 – 89 mm |
| 05 0526 01090 | 95 mm | 90 – 94 mm |
| 05 0526 01095 | 100 mm | 95 – 99 mm |
| 05 0526 01000 | 105 mm | 100 – 104 mm |



| | |
|-----|--------------------------|
| 496 | Fittings for glass doors |
| 504 | Glass-door boxes |
| 513 | Glass-door hinges |
| 516 | Doorknobs |
| 518 | Sliding door handles |
| 519 | Door holders |
| 521 | Technical information |

Fittings for glass doors

Added value at a glance

Glass has always been a versatile architectural material, and glass doors carry this role into the sphere of interior design. Sliding glass doors also make efficient use of space and open up smaller rooms. FSB offers a range of glass door fittings that are compelling both in their contributions to design and to function.

Acoustically attenuated latch bolt in a combination of plastic/pressure die casting

Diverse materials and finishes in aluminium, stainless steel and bronze

Integrated in existing handle ranges for continuity of design and use of materials

Heavy-duty glass door lock DIN 18250 and 18251 based on grade 4

Pared-down dimensioning of the lock cover



Fittings with consistent design for glass doors in combination with doorknobs, sliding door handles and hinges

Pre-fitted for glass thicknesses 8 and 10 mm



Can be combined with over 50 different door handle models



Variants for emergency exit devices conforming to EN 179 available with APD or APE panic function

Fire safety variants conforming to DIN 18273 available for tempered safety glass (10 and 24 mm)

Variants with or without round/square handle rose; alternatively also with CH-RC round cylinder keyway

Fittings for glass doors

Product variants

Product features of glass door fittings

Our glass-door boxes can be combined with almost any FSB door handle model and are available with or without profile cylinder (PC) keyway. Please specify when ordering:

- Door handle model
- DIN door handing

In addition to glass-door boxes, the following pages also present matching strike boxes, door hinges and a door holder.

Standard variant Glass door fitting 13 4231



Illustrative example featuring door handle 1244

13 4231 can be combined with:

- ☞ Door handles without handle roses

Cannot be combined with models 1163, 1241, 1242, 1251 and 1254

Standard variant Glass door fitting 13 4224



Illustrative example featuring door handle 1244

13 4224 can be combined with:

- ☞ Door handles without handle roses

Teflon-coated bushing with handle guide, which can withstand the mechanical forces exerted on large-format glass doors even though the glass door fitting is smaller and more discreet than models 13 4220 and 13 4223

Heavy-duty variant Glass door fitting 13 4223



Illustrative example featuring door handle 1244 and handle roses

13 4223 can be combined with:

- ☞ Door handles without handle roses
- ☞ Door handles with handle roses and FSB ASL® bearing (see page 56 f.) for light to medium heavy-duty doors
- ☞ Door handles with handle roses and FSB AGL® heavy-duty bearing (see page 58 f.) for heavy-duty and high-traffic doors

Heavy-duty variant
Glass door fitting 13 4220

Fire safety and EN 179 variant
Glass door fitting 13 4220 090

Other fittings for glass doors



Illustrative example featuring door handle 1244 and handle roses



Illustrative example featuring door handle 1244 and handle roses

13 4220 can be combined with:

- ☞ Door handles without handle roses
- ☞ Door handles with handle roses and FSB ASL® bearing (see page 56 f.) for light to medium heavy-duty doors
- ☞ Door handles with handle roses and FSB AGL® heavy-duty bearing (see page 58 f.) for heavy-duty and high-traffic doors

13 4220 090 can be combined with:

- ☞ Door handles with handle roses and FSB AGL® FS heavy-duty bearing (see page 58 f.) for heavy-duty and high-traffic doors in fire safety variant
- ☞ Door handles with handle roses and FSB AGL® FS heavy-duty bearing (see page 58 f.) for heavy-duty and high-traffic doors for emergency exit devices in fire safety variant conforming to EN 179

The range would not be complete without doorknobs and flush pulls for glass doors. Furthermore, all door pulls (except push/pull pad handles) and individually configurable pull handle systems can also be installed on glass doors with the right fixing set (see page 630 ff.).

If desired, glass door fittings from series 13 4220 04.../05..., 13 4223 and 13 4224 and their companion door handles can be powder-coated in any colour from the RAL colour chart to match the interior design concept.

6d

Fittings for glass doors

Overview

Glass-door boxes

13 4224 

Page 504 f.



13 4220 

Page 506 f.



13 4223 

Page 509 f.



13 4231 

Page 511 f.



Glass-door hinges

13 4228 ■ ■ ■
Page 514



13 4227 ■ ■ ■
Page 515



13 4232 ■ ■ ■
Page 513



Doorknobs

23 0802 ■ ■ ■ ■
Page 516



23 0828 ■ ■ ■
Page 517



23 0829 ■ ■ ■ ■
Page 517



23 0844 ■ ■ ■
Page 516



6d

Sliding door handles

13 4256 ■ ■ ■
Page 518



13 4256 ■ ■ ■
Page 518



13 4257 ■ ■ ■
Page 519



Door holders

13 4230 ■ ■
Page 519



Fittings for glass doors

Compact glass-door box

■ Aluminium
■ Stainless steel
■ Bronze



13 4224 ■ ■

↻ 13 4224 042 (R) | 13 4224 052 (L)

Compact rectangular glass door fitting with heavy-duty glass door lock (DIN 18251-1, grade 4)

Profile cylinder (PC) 72 mm, 8 mm self-tightening follower in steel with polyamide retaining ring

Latch bolt in a combination of plastic/pressure die casting, acoustically attenuated

Bolt head as bright nickel-plated casting; bearing with Teflon-coated bushing that wholly envelops the handle neck; can be combined with female handles

Pictured: DIN RH, opening inwards

The glass door fitting, developed in collaboration with Ingenhoven Architects, stands out for its pared-down design without handle roses, its extremely compact dimensions and the fact that it can be flush-fitted with the door frame (when using DIN frames). The fitting closes flush with DIN frame so that the door frame and fitting join together as one visual unit. Particularly delightful when combined with door handle 1078: the dividing line on the grip section aligns perfectly with the edge of the glass door fitting.

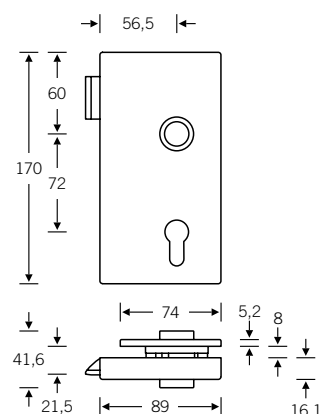

Please specify DIN door handing when ordering

↻ Female handles
 ↻ FSB ASL®
 ↻ FSB AGL®
 ↻ FS heavy-duty fitting
 ↻ EN 179 heavy-duty fitting
 For bearings, see page 52 ff.

Fittings for glass doors

Compact strike box

■ Aluminium
■ Stainless steel
■ Bronze



13 4224 ■ ■

13 4224 045 (R) | 13 4224 055 (L)



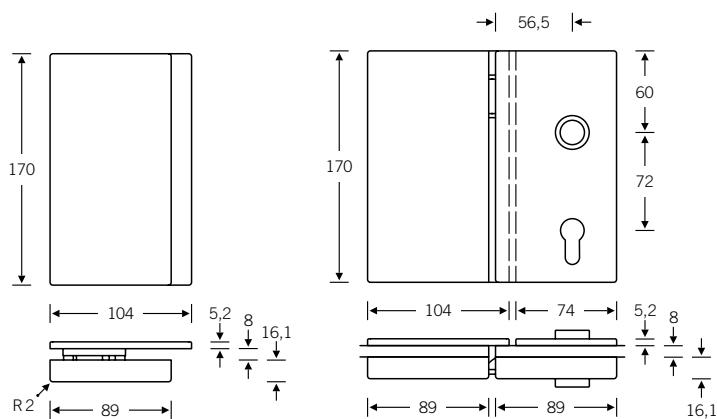

Compact rectangular strike box
for double-leaf glass doors
matching glass door fitting
13 4224 042 (R) | 13 4224 052 (L)

Pictured: DIN LH, opening inwards

6d



Please specify DIN door handing when ordering

-  Female handles
 -  FSB ASL®
 -  FSB AGL®
 -  FS heavy-duty fitting
 -  EN 179 heavy-duty fitting
- For bearings, see page 52 ff.

Fittings for glass doors

Glass-door boxes

- Aluminium
- Stainless steel
- Bronze



Model 13 4220 041



Model 13 4220 042

13 4220

- ⊖ 13 4220 041 (R) | 13 4220 051 (L)
- ⊕ 13 4220 042 (R) | 13 4220 052 (L)*
- ⊖ 13 4220 042 (R) | 13 4220 052 (L)*

Rectangular glass door fitting with heavy-duty glass door lock (DIN 18251-1, based on grade 4)

Profile cylinder (PC) 72 mm, 8 mm self-tightening follower in steel with polyamide retaining ring

Latch bolt in a combination of plastic/pressure die casting, acoustically attenuated

13 4220 041 (R) | 13 4220 051 (L)
Fitted for profile cylinder (PC); bolt head as bright nickel-plated casting; handle bushing in GFR polyamide; can be combined with female handles

13 4220 042 (R) | 13 4220 052 (L)
Fitted for profile cylinder (PC) with lifter assembly; bolt head as bright nickel-plated casting; pre-fitted for installation of door handles with handle roses and FSB ASL® bearing or FSB heavy-duty fitting with FSB AGL® bearing (also available in these two variants with square handle roses)

Pictured: DIN RH, opening inwards

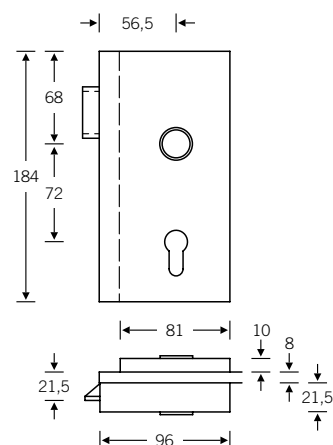

Please specify DIN door handing when ordering

* Not in bronze

- ⊖ Female handles
 - ⊕ FSB ASL®
 - ⊖ FSB AGL®
 - ⊕ FS heavy-duty fitting
 - ⊕ EN 179 heavy-duty fitting
- For bearings, see page 52 ff.

Fittings for glass doors

Strike box

- Aluminium
- Stainless steel
- Bronze



13 4220

13 4220 045 (R) | 13 4220 055 (L)

Rectangular strike box
for double-leaf glass doors
matching glass door fittings
13 4220 041 (R) | 13 4220 051 (L)
13 4220 042 (R) | 13 4220 052 (L)

Pictured: DIN LH, opening inwards

6d

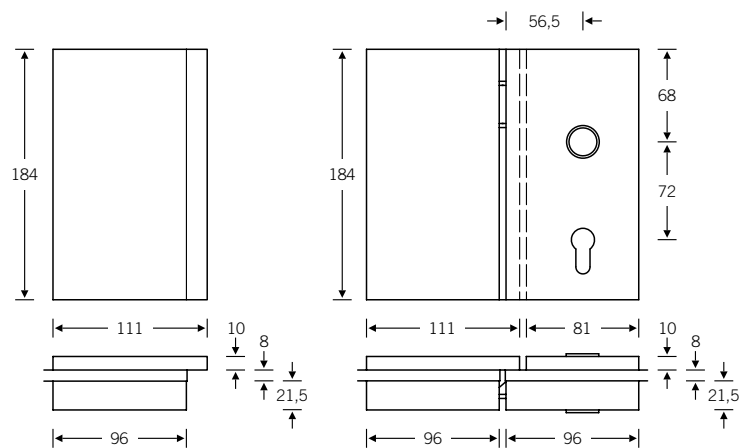

Please specify DIN door handing when ordering

Fittings for glass doors

Glass-door boxes for fire and panic doors

- Aluminium
- Stainless steel
- Bronze



13 4220 ■

Door thickness 24 mm

- ① 13 4220 09001 (R) | 13 4220 09002 (L)
Fire safety variant
- ① 13 4220 09003 (R) | 13 4220 09004 (L)
with APE panic function
(lever/knob set)
- ① 13 4220 09005 (R) | 13 4220 09006 (L)
with APD panic function
(lever/lever set)

Door thickness 10 mm

- ① 13 4220 09015 (R) | 13 4220 09016 (L)
Fire safety variant
- ① 13 4220 09007 (R) | 13 4220 09008 (L)
with APD panic function
(lever/lever set)
- ① 13 4220 09009 (R) | 13 4220 09010 (L)
with APE panic function
(lever/knob set)

Rectangular glass door fitting
with heavy-duty glass door lock (DIN 18250,
based on grade 4)

Fitted for profile cylinder (PC) with lifter
assembly; bolt head as bright nickel-plated
casting; fitted for installation of door hand-
les with handle roses and FSB heavy-duty
fittings with FSB AGL® bearing

Variant with square handle roses also
available

Pictured: DIN RH, opening inwards

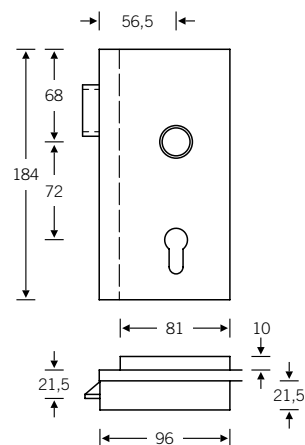

Please specify DIN door handing when
ordering

- ① Female handles
 - ① FSB ASL®
 - ① FSB AGL®
 - ① FS heavy-duty fitting
 - ① EN 179 heavy-duty fitting
- For bearings, see page 52 ff.

Fittings for glass doors

Glass-door boxes

- Aluminium
- Stainless steel
- Bronze



Model 13 4223 041



Model 13 4223 042

13 4223

- ⊖ 13 4223 041 (R) | 13 4223 051 (L)
- ⊕ 13 4223 042 (R) | 13 4223 052 (L)
- ⊖ 13 4223 042 (R) | 13 4223 052 (L)

Rectangular glass door fitting, round-cornered with heavy-duty glass door lock (DIN 18251-1, based on grade 4)

Profile cylinder (PC) 72 mm, 8 mm self-tightening follower in steel with polyamide retaining ring

Latch bolt in a combination of plastic/pressure die casting, acoustically attenuated

13 4223 041 (R) | 13 4223 051 (L)
Fitted for profile cylinder (PC); bolt head as bright nickel-plated casting; handle bushing in GFR polyamide; can be combined with female handles

13 4223 042 (R) | 13 4223 052 (L)
Fitted for profile cylinder (PC) with lifter assembly; bolt head as bright nickel-plated casting; pre-fitted for installation of door handles with handle roses and FSB ASL® bearing or FSB heavy-duty fitting with FSB AGL® bearing (also available in these two variants with square handle roses)

Pictured: DIN RH, opening inwards

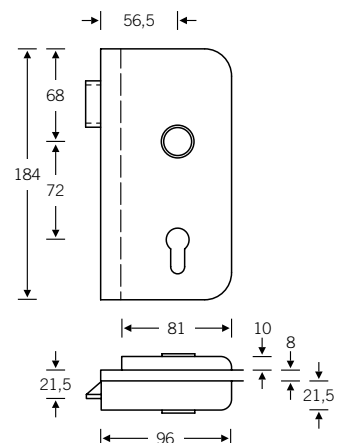

6d

Please specify DIN door handing when ordering



- ⊖ Female handles
 - ⊕ FSB ASL®
 - ⊖ FSB AGL®
 - ⊕ FS heavy-duty fitting
 - ⊖ EN 179 heavy-duty fitting
- For bearings, see page 52 ff.

Fittings for glass doors

Strike box

- Aluminium
- Stainless steel
- Bronze



13 4223  

13 4223 045 (R) | 13 4223 055 (L)

Rectangular strike box, round-cornered
for double-leaf glass doors
matching glass door fittings

13 4223 041 (R) | 13 4223 051 (L)

13 4223 042 (R) | 13 4223 052 (L)

Pictured: DIN LH, opening inwards

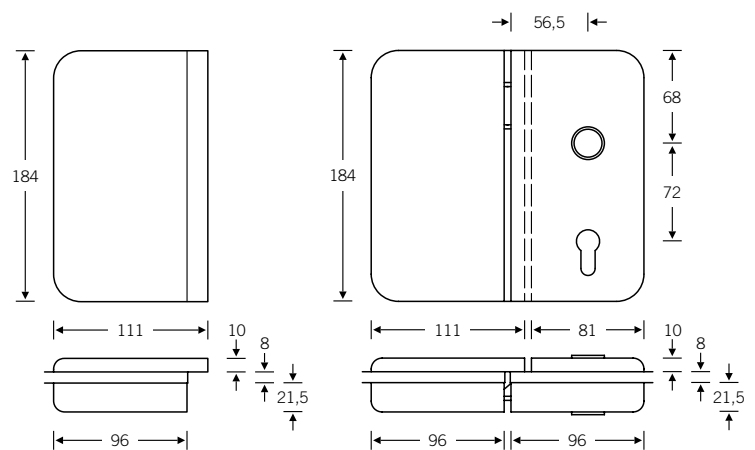

Please specify DIN door handing when ordering

Fittings for glass doors

Glass-door box

- Aluminium
- Stainless steel
- Bronze



13 4231

- ⊕ 13 4231 00001 (without PC keyway)
- ⊕ 13 4231 00010 (with PC keyway)

Latch bolt can be modified from right to left; cannot be combined with door handle models 1163, 1241, 1242, 1251 and 1254

Only available in Aluminium, Natural Colour, Anodised (FSB 0105) and Stainless Steel, Brushed Satin Matt (FSB 6204)

Pictured: DIN RH, opening inwards

6d

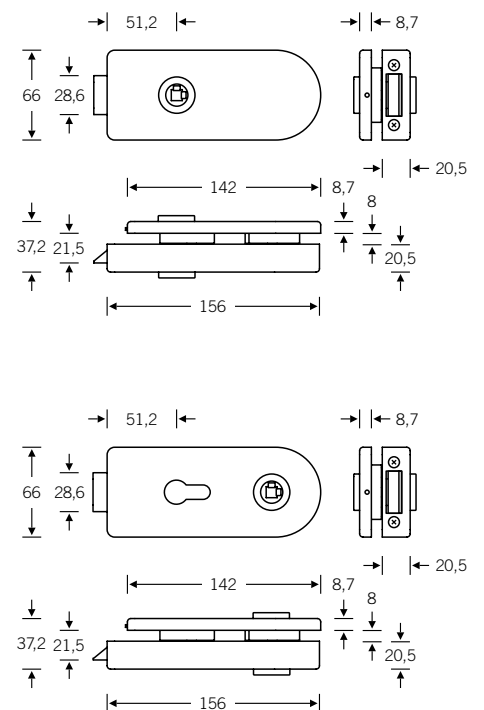

Please specify DIN door handing when ordering



- ⊕ Female handles
 - ⊕ FSB ASL®
 - ⊕ FSB AGL®
 - ⊕ FS heavy-duty fitting
 - ⊕ EN 179 heavy-duty fitting
- For bearings, see page 52 ff.

Fittings for glass doors

Strike box

- Aluminium
- Stainless steel
- Bronze



13 4231  

13 4231 01001



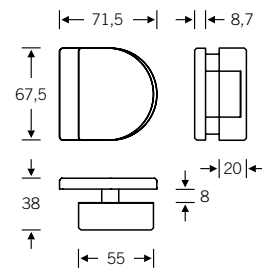

Semi-circle strike box
matching glass door fitting 13 4231

Only available in Aluminium, Natural Colour,
Anodised (FSB 0105) and Stainless Steel,
Brushed Satin Matt (FSB 6204)

Pictured: DIN LH, opening inwards



Please specify DIN door handing when
ordering

-  Female handles
 -  FSB ASL®
 -  FSB AGL®
 -  FS heavy-duty fitting
 -  EN 179 heavy-duty fitting
- For bearings, see page 52 ff.

Fittings for glass doors

Glass-door hinge

■ Aluminium
■ Stainless steel
■ Bronze



13 4232 ■

13 4232 00001

Glass-door hinge
in matt chrome-plated steel



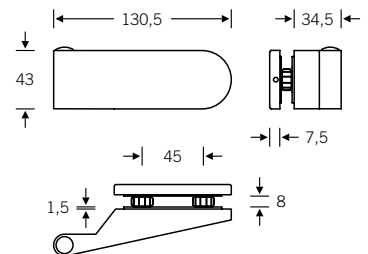

Only available in Aluminium, Natural Colour, Anodised (FSB 0105). Finish FSB 3427 (Aluminium, Anodised, in stainless steel look) is available for matching to stainless steel fittings.

Load capacity: 60 kg, 2 hinges
90 kg, 3 hinges

6d



Please specify DIN door handing when ordering

-  Female handles
 -  FSB ASL®
 -  FSB AGL®
 -  FS heavy-duty fitting
 -  EN 179 heavy-duty fitting
- For bearings, see page 52 ff.

Fittings for glass doors

Angular glass-door hinge

- Aluminium
- Stainless steel
- Bronze



13 4228

VARIANT glass-door hinge
in matt chrome-plated steel and stainless
steel, with receiver

Matching glass door fittings from series
13 4220 and 13 4224

Finishes:

- material matt chrome-plated steel only
available in Aluminium, Natural Colour,
Anodised
- material stainless steel only available in
Brushed Satin Matt

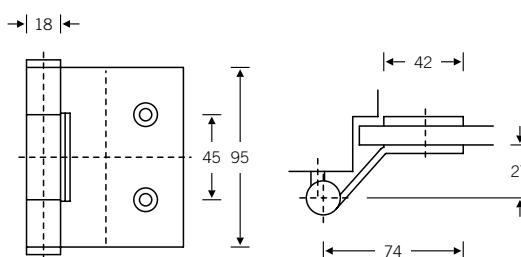

VARIANT heavy-duty hinges

13 4228 00101 for glass doors in rebated
timber, steel or aluminium frames

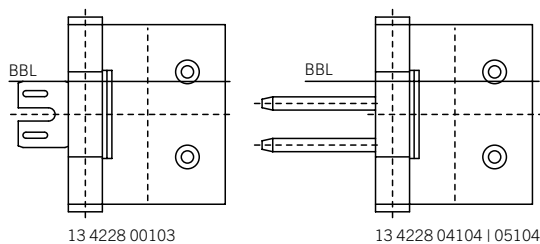
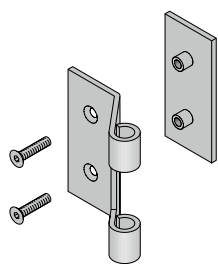
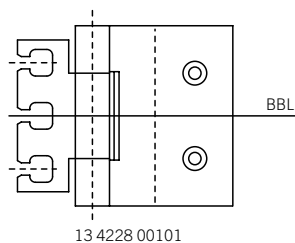

13 4228 00103 for glass doors in rebated
steel frames

13 4228 04104 (R) | 13 4228 05104 (L)
for glass doors in rebated timber-casing
and block frames

Load capacity:

60 kg, 2 hinges
90 kg, 3 hinges

Glass-door hinges pre-fitted for glass
thicknesses 8 and 10 mm

Fittings for glass doors

Round glass-door hinge

- Aluminium
- Stainless steel
- Bronze



13 4227

VARIANT glass-door hinge
in matt chrome-plated steel and stainless
steel, with receiver

Matching glass door fittings from series
13 4223

Finishes:

- material matt chrome-plated steel only
available in Aluminium, Natural Colour,
Anodised
- material stainless steel only available in
Brushed Satin Matt

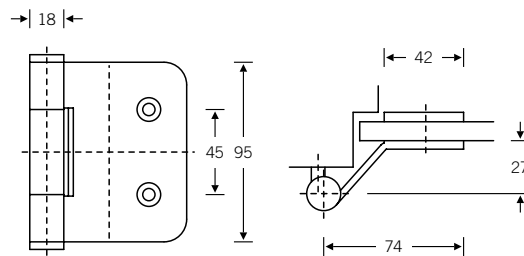

VARIANT heavy-duty hinges

6d

13 4227 00101 for glass doors in rebated
timber, steel or aluminium frames

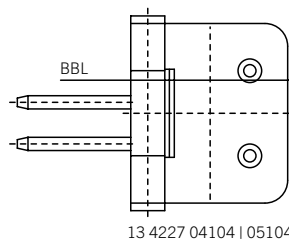
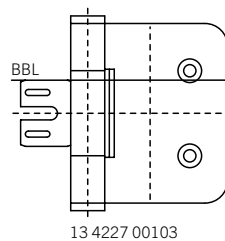
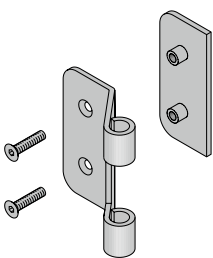
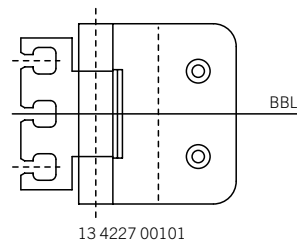

13 4227 00103 for glass doors in rebated
steel frames

13 4227 04104 (R) | 13 4227 05104 (L)
for glass doors in rebated timber-casing
and block frames

Load capacity:

60 kg, 2 hinges
90 kg, 3 hinges

Glass-door hinges pre-fitted for glass
thicknesses 8 and 10 mm

Fittings for glass doors

Doorknobs

- Aluminium
- Stainless steel
- Bronze



23 0802

23 0802 00007

Aluminium X = 77 mm
Stainless steel X = 73 mm
Bronze X = 72 mm

Drill hole \varnothing 13 mm

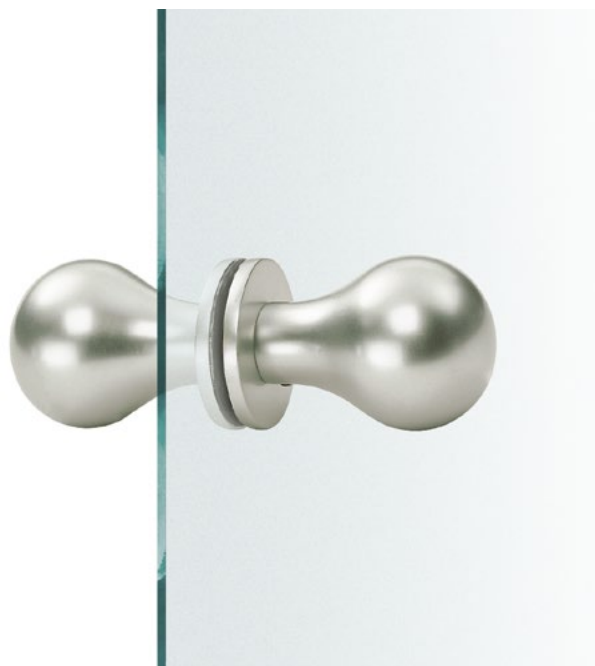
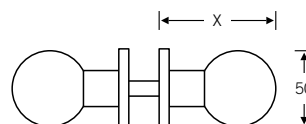

23 0844

23 0844 00007

Design: Jasper Morrison

Drill hole \varnothing 13 mm

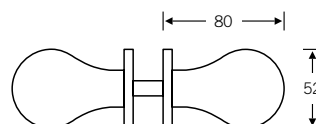

Fixed knobs

With glass doors, doorknobs are fitted directly as a rule and are not free to rotate. No locks are fitted. Sets are assembled by fitting the doorknobs to either end of an 8 mm square spindle (for two female handles).

Fittings for glass doors

Doorknobs

■ Aluminium
■ Stainless steel
■ Bronze



23 0828

23 0828 00007

Drill hole \varnothing 13 mm

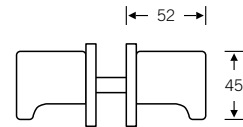

23 0829

23 0829 00007

Aluminium \varnothing = 50 mm
Stainless steel \varnothing = 55 mm
Bronze \varnothing = 50 mm

Drill hole \varnothing 13 mm

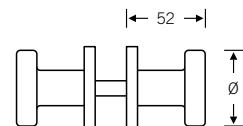

6d

Fixed knobs

With glass doors, doorknobs are fitted directly as a rule and are not free to rotate. No locks are fitted. Sets are assembled by fitting the doorknobs to either end of an 8 mm square spindle (for two female handles).

Fittings for glass doors

Sliding door handles

- Aluminium
- Stainless steel
- Bronze

13 4256

| Product code | B | A |
|---------------|-------|-------|
| 13 4256 00100 | 8 mm | 16 mm |
| 13 4256 00200 | 10 mm | 18 mm |
| 13 4256 00300 | 12 mm | 20 mm |

Glass thickness = B; total thickness = A

Open variant

Pair for either side of the door
Glass cut-out \varnothing 70 mm

No adhesives required; back-to-back fixing with countersunk screws \varnothing 3.9 mm, included in scope of delivery

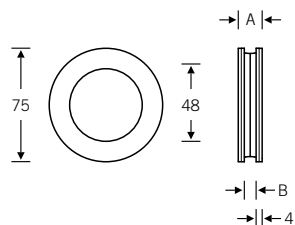

13 4256

| Product code | B | A |
|---------------|-------|-------|
| 13 4256 00101 | 8 mm | 20 mm |
| 13 4256 00201 | 10 mm | 22 mm |
| 13 4256 00301 | 12 mm | 24 mm |

Glass thickness = B; total thickness = A

Enclosed variant

Pair for either side of the door
Glass cut-out \varnothing 70 mm

No adhesives required; back-to-back fixing with countersunk screws \varnothing 3.9 mm, included in scope of delivery

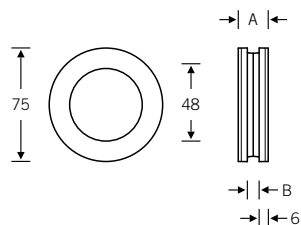

Fittings for glass doors

Sliding door handle and door holder

■ Aluminium
■ Stainless steel
■ Bronze



13 4257 ■ ■

Enclosed variant

Pair for either side of the door
Glass cut-out 75 mm × 75 mm

No adhesives required; back-to-back fixing with countersunk screws \varnothing 3.9 mm, included in scope of delivery

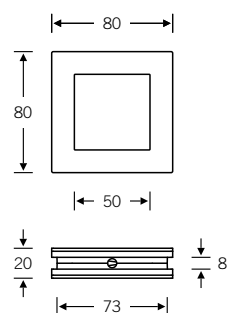

13 4230 ■

| Product code | B | A |
|--------------|-------|-------|
| 13 4230 000 | 8 mm | 27 mm |
| 13 4230 010 | 10 mm | 29 mm |
| 13 4230 012 | 12 mm | 31 mm |

6d

Glass thickness = B; total thickness = A

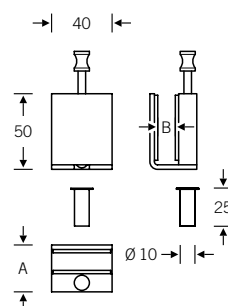

521 **Technical information**
Fittings for glass doors

Technical information

Glass door measurements pursuant to DIN 18101

Glass cut-outs for series 13 4220 – 13 4224 Profile cylinder

The glass door fittings and strike boxes are pre-fitted: series 13 4220 and 13 4223 for glass door thicknesses 8 and 10 mm, and series 13 4224 for 8 mm.

Profile cylinders with lengths of 25/25 mm or 27.5/27.5 mm are recommended owing to the small projection achieved. Profile cylinders 25/25 mm must be checked on a case-by-case basis to ensure they are compatible with the locking system.

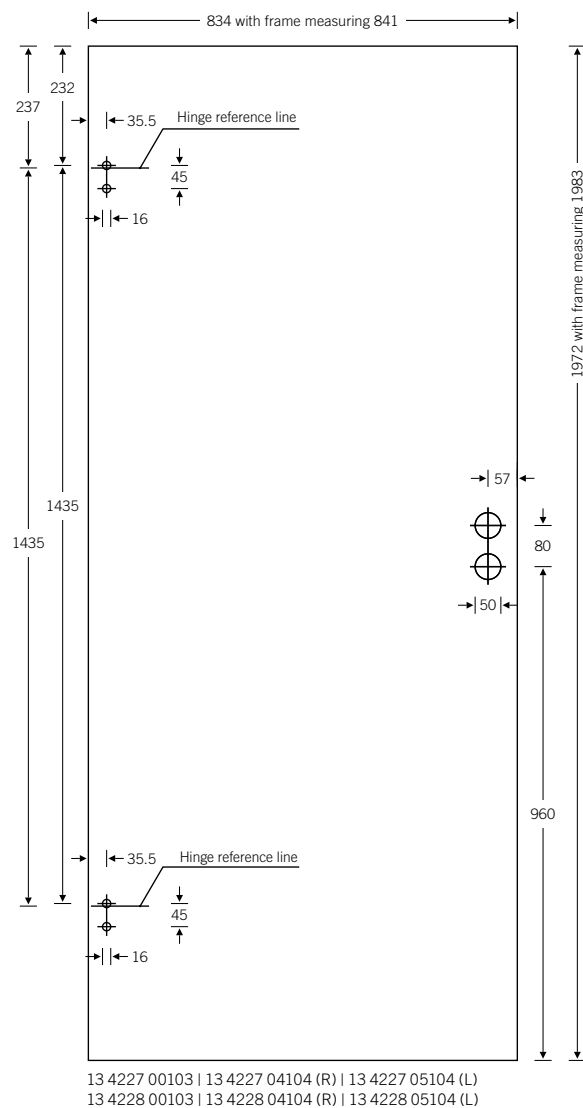
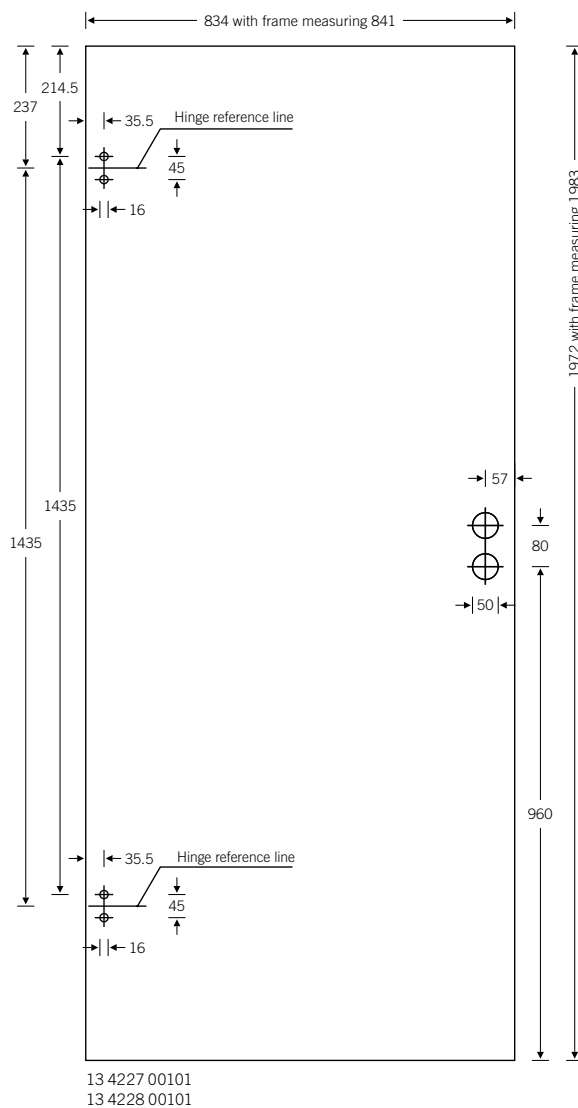

| | | | |
|--------------------------------|---------------|---------------|----------------|
| Approximate carcass dimensions | 750 × 2000 mm | 875 × 2000 mm | 1000 × 2000 mm |
| Frame rebate dimensions | 716 × 1983 mm | 841 × 1983 mm | 966 × 1983 mm |
| Standard glass dimensions | 709 × 1972 mm | 834 × 1972 mm | 959 × 1972 mm |

| | | | |
|--------------------------------|---------------|---------------|----------------|
| Approximate carcass dimensions | 750 × 2125 mm | 875 × 2125 mm | 1000 × 2125 mm |
| Frame rebate dimensions | 716 × 2108 mm | 841 × 2108 mm | 966 × 2108 mm |
| Standard glass dimensions | 709 × 2097 mm | 834 × 2097 mm | 959 × 2097 mm |

Technical information

Glass door measurements pursuant to DIN 18101

Glass cut-outs for series 13 4231

The glass door fittings and strike boxes are pre-fitted for glass thickness 8 mm.

Profile cylinder

Profile cylinders with lengths of 25/25 mm or 27.5/27.5 mm are recommended owing to the small projection achieved. Profile cylinders 25/25 mm must be checked on a case-by-case basis to ensure they are compatible with the locking system.

Active leaf:

Inactive leaf:

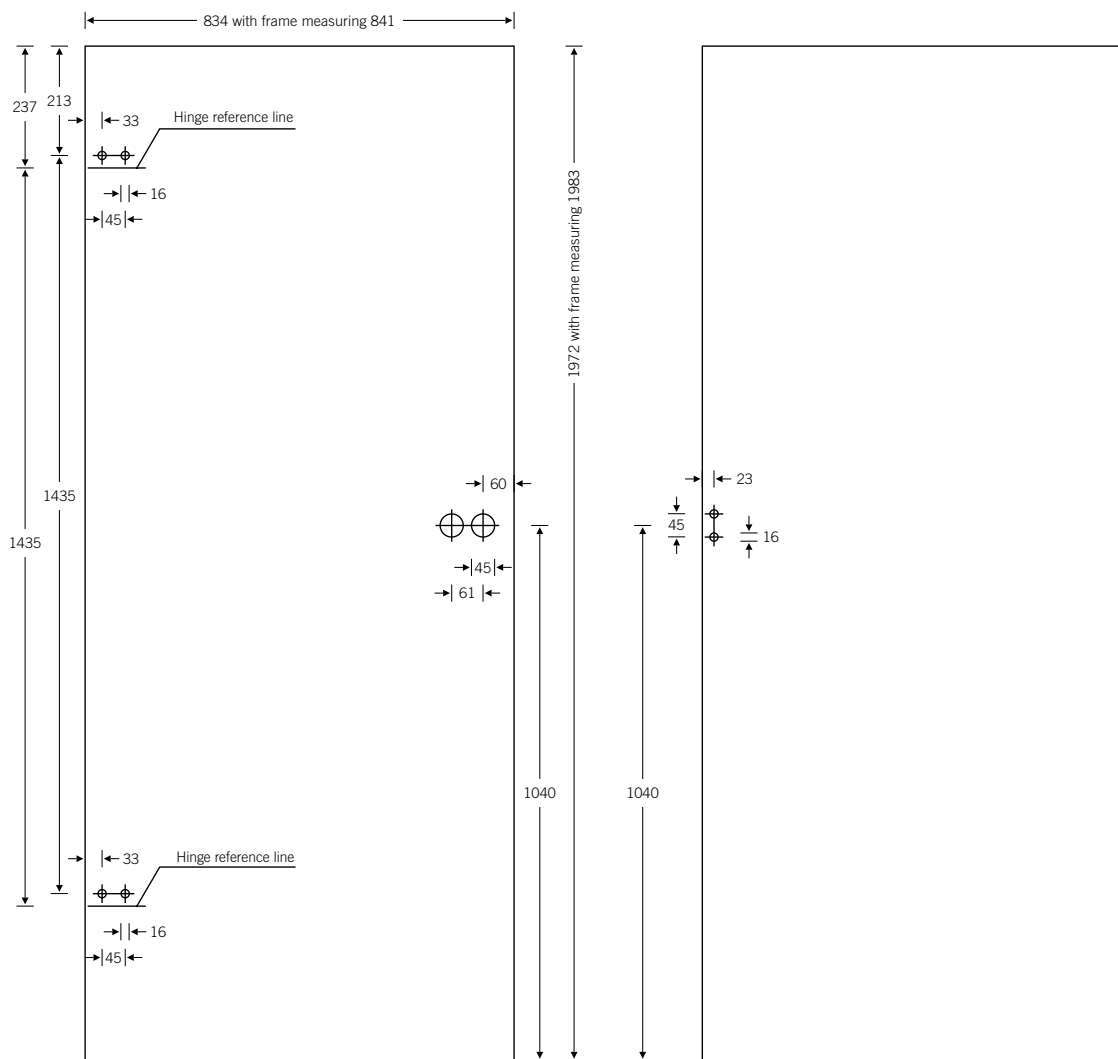

13 4232 00001

| | | | |
|--------------------------------|---------------|---------------|----------------|
| Approximate carcass dimensions | 750 × 2000 mm | 875 × 2000 mm | 1000 × 2000 mm |
| Frame rebate dimensions | 716 × 1983 mm | 841 × 1983 mm | 966 × 1983 mm |
| Standard glass dimensions | 709 × 1972 mm | 834 × 1972 mm | 959 × 1972 mm |

| | | | |
|--------------------------------|---------------|---------------|----------------|
| Approximate carcass dimensions | 750 × 2125 mm | 875 × 2125 mm | 1000 × 2125 mm |
| Frame rebate dimensions | 716 × 2108 mm | 841 × 2108 mm | 966 × 2108 mm |
| Standard glass dimensions | 709 × 2097 mm | 834 × 2097 mm | 959 × 2097 mm |

Technical information

Receivers for 13 4227 and 13 4228

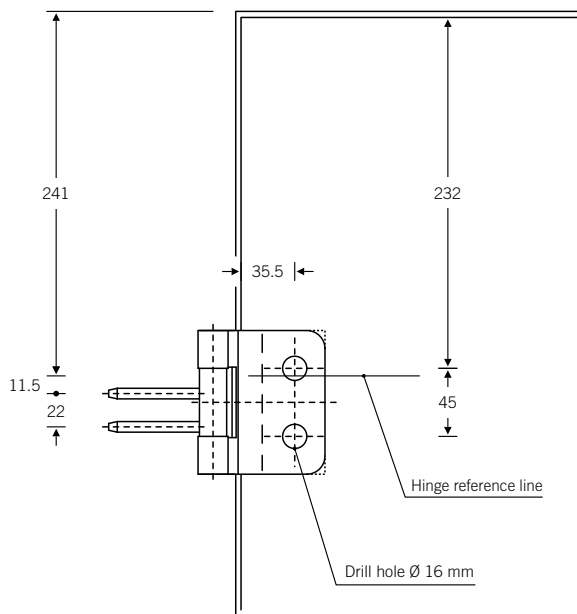
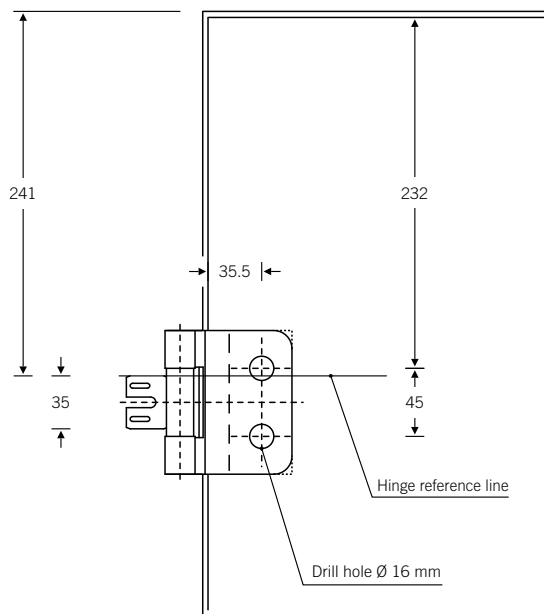
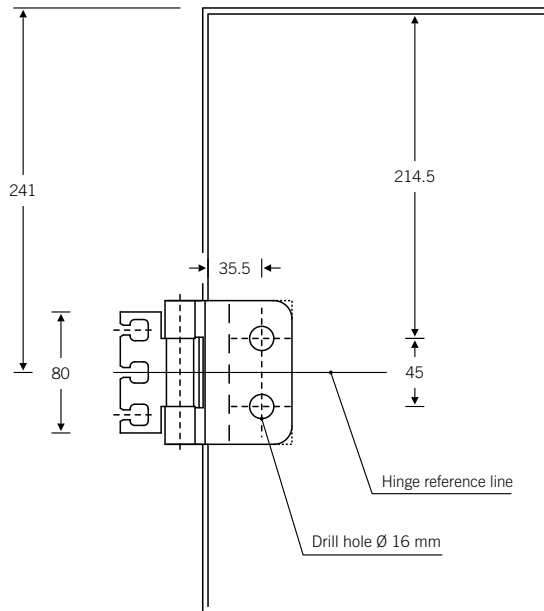

Receivers and their position relative to the hinge reference line also determine the positioning of drill holes in the glass door. This should be taken into consideration especially in the case of FSB heavy-duty hinges 13 4227 00101 and 13 4228 00101.

Technical information

Frame connection dimensions for 13 4227 and 13 4228

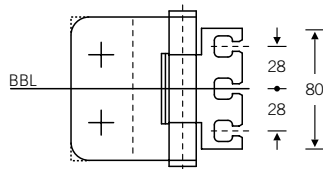

13 4227 00101 (round)
13 4228 00101 (angular)

VARIANT heavy-duty hinge for glass doors in rebated timber, steel or aluminium frames

- Designed for wholly glazed doors with standard vertical drill hole layout
 - For glass thicknesses 8 and 10 mm
 - Non-twist threaded pin
 - Concealed, maintenance-free axial/radial sliding bearing
- Can be combined with receiver:

| | |
|----------------------|------------|
| for block frames | VX 7501 3D |
| for casing frames | VX 7502 3D |
| for block frames | VX 7505 3D |
| for steel frames | VX 7611 3D |
| | VX 7612 3D |
| for aluminium frames | VX 7521 3D |
 - Non-handed

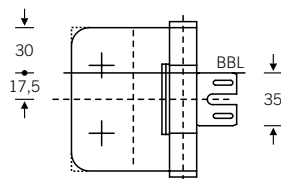

13 4227 00103 (round)
13 4228 00103 (angular)

VARIANT heavy-duty hinge for glass doors in rebated steel frames

- Designed for wholly glazed doors with standard vertical drill hole layout
- For glass thicknesses 8 and 10 mm
- For receiver V 8600 or V 8610
- Non-handed

6d

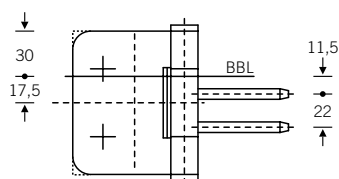

13 4227 04104 (R) | 05104 (L) | (round)
13 4228 04104 (R) | 05104 (L) | (angular)

VARIANT heavy-duty hinge for glass doors in rebated timber-casing and block frames

- Designed for wholly glazed doors with standard vertical drill hole layout
- For glass thicknesses 8 and 10 mm
- For receivers from series V 3600, V 3610, V 3630, V 3650, V 3690 and clamping block V 3604 or V 3607
- DIN door handing must be specified

Further information about hinges, receivers, frame fixing elements, etc. can be found in the latest SIMONSWERK manual.

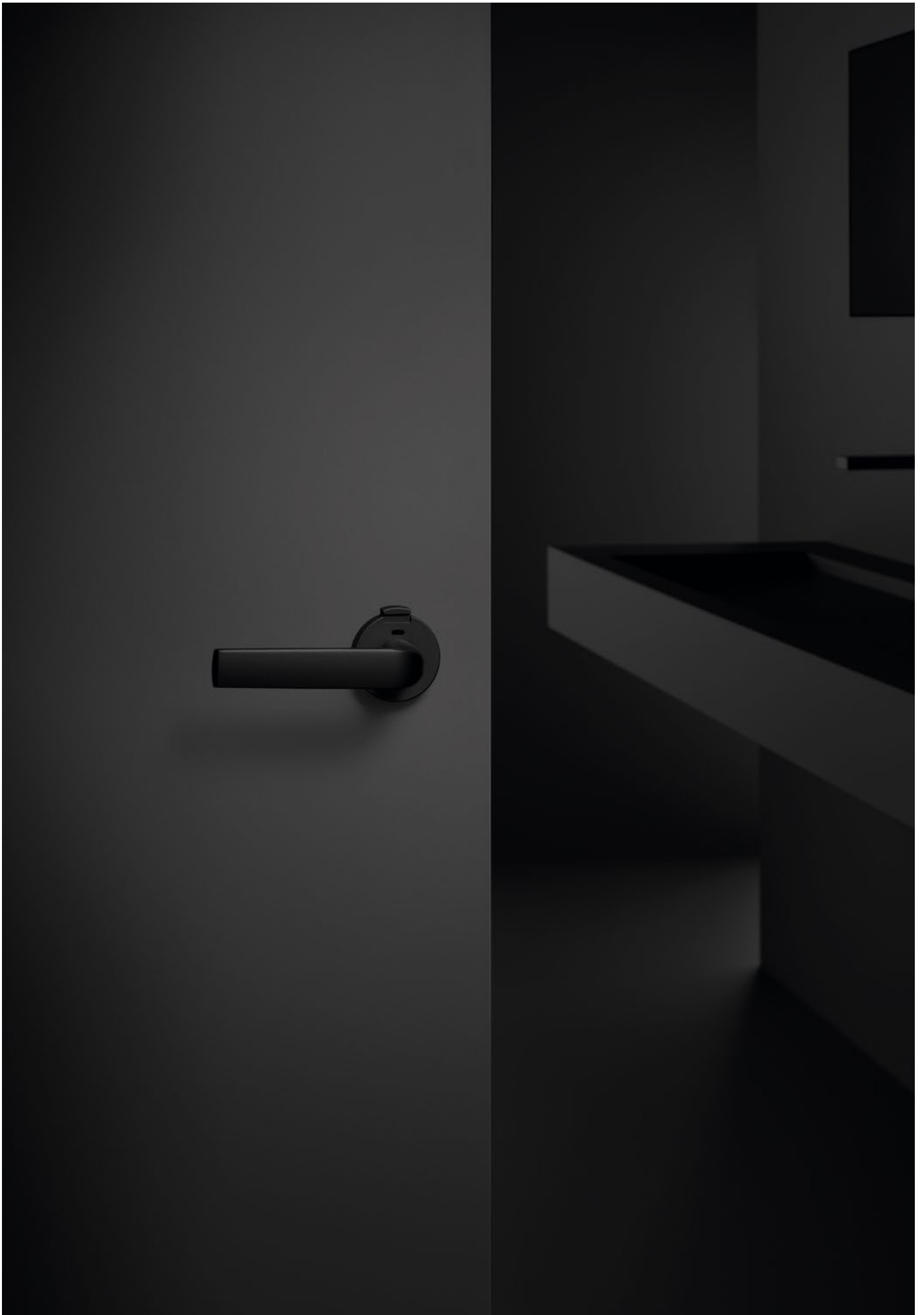

526 Lever handles with privacy function

Lever handles with privacy function

Added value at a glance

The trend in premium-quality civic/commercial and residential construction is towards minimalism. Products blend in unobtrusively with their surroundings but at the same time they need to remain visible and functional for those who use them. That also applies

to bathroom/toilet doors – or any other door expected to afford privacy when required. FSB has rethought the locking process by integrating the lock directly into the handle rose of the FSB ASL® set, eliminating the need for a key rose.

Like a ballpoint pen: pushing the button locks the handle and pushing it again releases it

Locking device integrated in the handle rose; no key rose necessary

Privacy button on the inside

Minimalist design: ideal for premium commercial and residential buildings

Universal design: comfortable one-handed operation

Can be combined with standard mortice locks



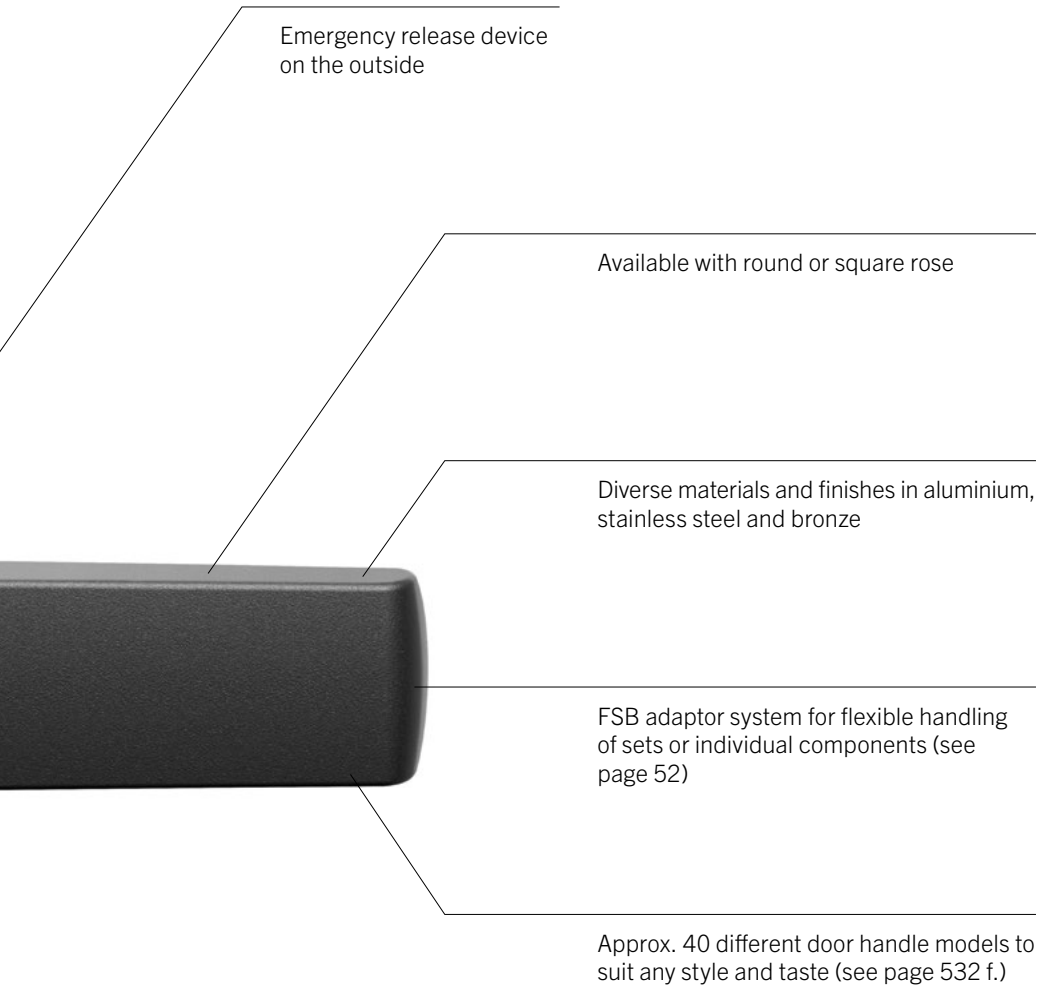

Lever handles with privacy function

Product variants

Product features of lever handles with privacy function

- Round or square rose
- 8 and 8.5 mm square spindle
- Rose on the inside has privacy button, rose on the outside has emergency release
- Available as a set and as individual parts

Lever/lever set with round rose



Open (inside)



Locked (inside)

- 12 04720 (spindle 8 mm)
- 12 04721 (spindle 8.5 mm)

Lever/lever set with square rose



Open (inside)



Locked (inside)

- 12 04920 (spindle 8 mm)
- 12 04921 (spindle 8.5 mm)

For optimal preparation of the door for installing the lever handle with privacy function, FSB provides a drilling template, which can be ordered separately using product code 03 0455 03000 6000.

The companion accessory bag when ordering individual parts can be found on page 351.

Inside handle rose round/square

Outside handle rose round/square with emergency release



- 12 1799 00124 (round, spindle 8 and 8.5 mm)
- 12 1799 00125 (square, spindle 8 and 8.5 mm)

- 12 1731 00801 (round, spindle 8 and 8.5 mm)*
- 12 1703 00801 (square, spindle 8 and 8.5 mm)*

Accessory bags for the different spindle thicknesses must be ordered separately.

* Note: during installation, a screw hole must be drilled underneath the lock follower for the emergency release device. The emergency release has a diameter of 3 mm and can be operated with standard household tools or even a nail.

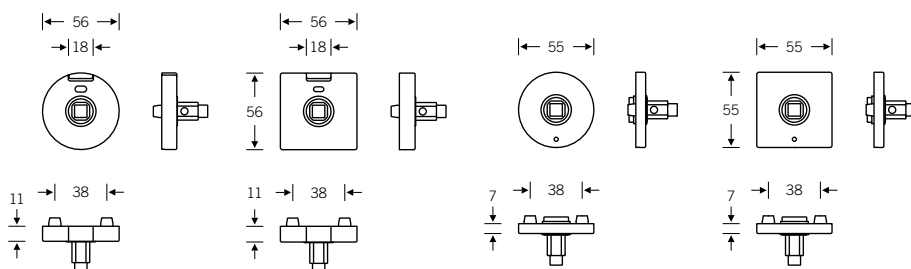

Lever handles with privacy function

Overview

1001

Page 81



1003

Page 87



1004

Page 91



1005

Page 97



1015

Page 103



1016

Page 109



1021

Page 115



1023

Page 119



1035

Page 125



1045

Page 131



1051

Page 137



1058

Page 141



1070

Page 145



1075

Page 151



1076

Page 155



1078

Page 161



1093

Page 161



1102

Page 173



1106

Page 179



1107

Page 185



1108

Page 191



1119

Page 197



1144

Page 207



1146

Page 213



1147 ■ ■
Page 219



1159 ■ ■
Page 225



1160 ■ ■
Page 231



1163 ■ ■ ■
Page 237



1176 ■ ■
Page 243



1183 ■ ■
Page 247



1226 ■
Page 253



1232 ■
Page 257



1241 ■
Page 263



1242 ■ ■ ■
Page 267



1244 ■ ■
Page 273



1246 ■
Page 279



1251 ■ ■
Page 285



1254 ■
Page 289



1267 ■ ■ ■
Page 295



1271 ■ ■
Page 301



1285 ■
Page 307



6e

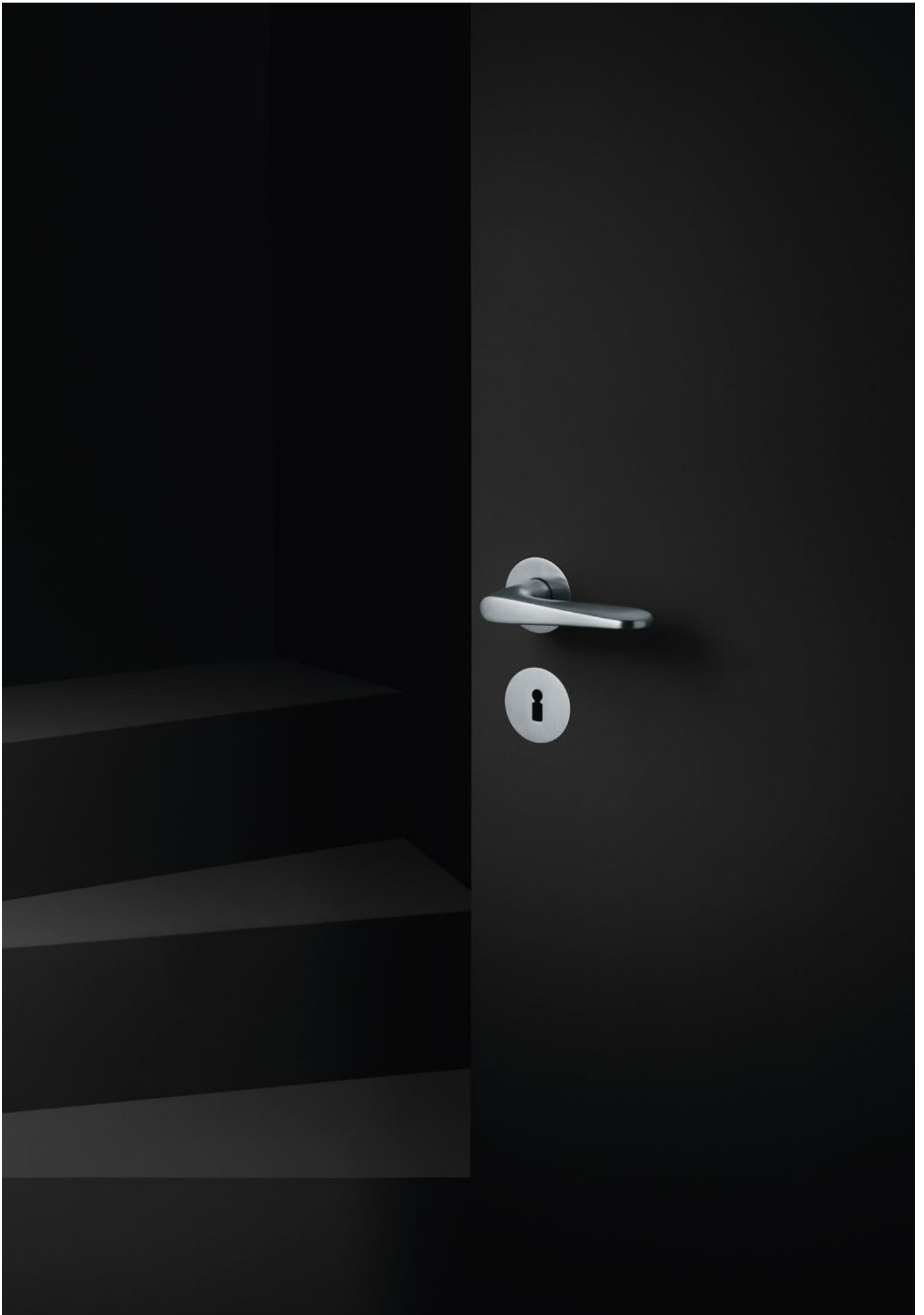

- 534 Flush-fitted hardware
- 538 Flush-fitted FSB AGL[®] sets

Flush-fitted hardware

Product variants

It is not for reasons of modesty that we make our fittings virtually sink into their surroundings. With our flush-fitted product solutions, we have set a standard that has become established among architects and design-oriented home builders alike.

Routed edge radii on the roses and a precisely matched routing jig ensure an exact fit and achieve exclusive door design without CNC machining.

Flush-fitted door handles are available with round and square roses. The individual parts can also be configured to create a set (see page 316 ff.).

FSB AGL® set with round rose



Illustrative example featuring FSB 1144

- ↶ 72 8....
- ↷ 76 8....
- ↸ 79 8....

- For door thicknesses of 45 mm upwards
- Turnably fixed FSB AGL® bearing with positive mechanism
- Round roses
- Lever/lever sets, lever/knob sets, WC sets available
- Aluminium, stainless steel, bronze

The following models are not available flush-fitted with FSB AGL®: FSB 1016, 1043 1070, 1074, 1090, 1093, 1094, 1117, 1118, 1119, 1155, 1159, 1160 and 1287

Further information about FSB AGL® sets with round roses can be found on page 538 f.

Standard variant with round rose



Illustrative example featuring FSB 1003

- 17 1736 10001(handle rose 8 mm)
- 17 1737 00... (key rose)

- Suitable for standard door thicknesses of 38–42 mm; available up to door thickness 67 mm (please specify door thickness when ordering)
- Adaptor system without positive mechanism
- Metal guide ring
- Available as individual parts
- No FS variant available
- Warded lock (WL), profile cylinder (PC) and WC variants
- Aluminium, stainless steel

The following models are not available as flush-fitted variants: FSB 1051, 1058, 1163, 1241, 1251, 1254, 1285

Further information about round flush-fitted roses can be found on page 364.

Standard variant with square rose



Illustrative example featuring FSB 1003

- 17 1733 10001(handle rose 8 mm)
- 17 1734 00... (key rose)

- Suitable for standard door thicknesses of 38–42 mm; available up to door thickness 67 mm (please specify door thickness when ordering)
- Adaptor system without positive mechanism
- Metal guide ring
- Available as individual parts
- No FS variant available
- Warded lock (WL), profile cylinder (PC) and WC variants
- Aluminium, stainless steel

The following models are not available as flush-fitted variants: FSB 1051, 1058, 1163, 1241, 1251, 1254, 1285

Further information about square flush-fitted roses can be found on page 365.

For continuity of design across all relevant elements, there is flush-fitted hardware for windows. Nearly all FSB window handles with a click-stop mechanism can be supplied as completely flush-fitted variants – in RAL quality and fully suited to the building in question, of course.

The flush-fitted security roses from series 73 7396 also fit in perfectly with the design concept of flush-fitted fittings for internal doors, extending it to the entrance door.

Window handles with oval and angular rose



Illustrative example featuring FSB 1003 or FSB 1035

34 09034 (oval rose)
34 09036 (angular rose)

- Rose dimensions: 25.5 × 60.5 × 10.2 mm (w × h × d)
- Cover rose clips onto rose base
- Variable spindle projection of 14–28 mm
- For custom spindle projection, please specify when ordering
- Length of spindle accommodated within the adaptor at least 25 mm
- Aluminium, stainless steel, bronze

The following models are not available as flush-fitted window handles: FSB 1021, 1045, 1058, 1135, 1163, 1176, 1226

Further information about flush-fitted window handles can be found on page 410.

Round security rose for flush doors



73 7396 01010 (with cylinder guard)
73 7396 02010 (without cylinder guard)

- For door thicknesses of 56 mm upwards
- Tested and certified under DIN 18257 ES 1 and DIN 18273 for fire doors
- Set includes flush-fitted variants on both sides
- M5 screws for fixing
- Can be combined with door pull
- Aluminium, stainless steel, bronze

Further information about flush-fitted security roses can be found on page 741.

Flush-fitted hardware

Flush-fitted FSB AGL® sets

■ Aluminium
■ Stainless steel
■ Bronze



- | | | |
|-------------|--|-------------|
| 72 ... 8... | | 72 ... 8... |
| 76 ... 8... | | 76 ... 8... |
| 79 ... 8... | | 79 ... 8... |
- + Model number of the door handle
- + Set type:
 813 (R) | 814 (L) lever/lever set
 815 (R) | 816 (L) lever/knob set
 23 0802
 817 (R) | 818 (L) lever/knob set
 23 0829
 819 (R) | 820 (L) WC set (not in FSB AGL® FS)
- Suitable for door thicknesses of 45 mm upwards

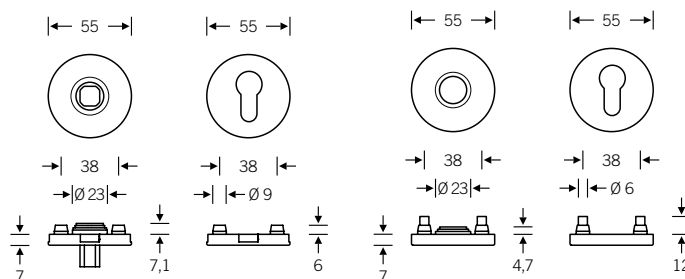

Specification:

FSB AGL® 72: rose set, turnably fixed bearing in Teflon-coated metal bearing bushings for tolerance compensation

FSB AGL® FS 76 + 79: rose set, turnably fixed bearing for fire doors and smoke control doors

Note:

Routing work performed on existing fire and smoke control doors in preparation for installing flush-fitted hardware renders the door's fire-safety status void. Please consult the door maker on whether there is fire-safety approval for installing flush-fitted hardware on the door concerned or whether an exception can be made in this case.

Order details required:

- FSB AGL® FS set
- Door thickness
- Door handle model*, see page 76 ff.
- Keyway
- Material/finish
- Quantity

* The following models are not available in a flush-fitted variant as an FSB AGL® set: FSB 1016, 1043, 1070, 1074, 1090, 1093, 1094, 1117, 1118, 1119, 1155, 1159, 1160 and 1287

- FSB ASL®
 - FSB AGL®
 - FS heavy-duty fitting
 - EN 179 heavy-duty fitting
- For bearings, see page 52 ff.

Flush-fitted hardware

Flush-fitted FSB AGL® sets

We provide CAD data for CNC routing. You can find these online in our digital catalogue at www.fsb.de/catalogue

Technical prerequisites: the door must be at least 45 mm thick; in the case of rebated doors, bear in mind the position of the lock mortise as well.

Drilling: to accommodate the stabiliser lugs, drill holes 9 mm in diameter at 38 mm centres to a depth of at least 7 mm – please use the FSB 03 0460 universal template for this.

(For the FSB 03 0460 universal template, see page 775)

Routing: the recess for the roses needs to be 55.6 mm in diameter, centred on the lock follower and routed to a depth of 7 mm. The remaining material between the bottom of the recess and the lock case must be stable and firm enough to ensure secure fastening without any pressure being exerted upon the lock.

(For the FSB 03 0462 000.. routing jig, see page 782)

Keyways and WC variants

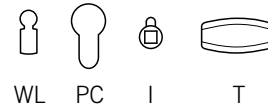

(Please request other keyways and centres individually)

FSB AGL® WC roses for flush-fitted installation

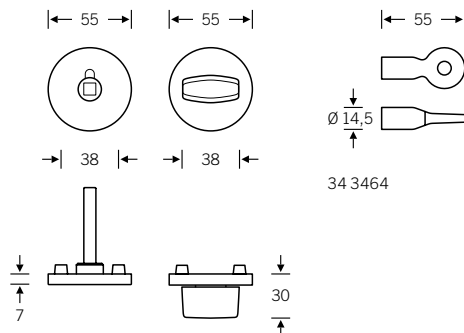



- 542 Fittings for sliding doors
- 576 Recessed lever handles
- 588 Fittings for emergency exit and panic doors
- 612 XXL door handles

FSB caters to all aspects of handle culture in built space from a single source. This includes fittings for special doors and application areas. Sliding doors are a particularly good way to connect rooms and save space at the same time. Our delightful recessed handles complete this design concept. Even where functional aspects are the most important considerations, FSB continues to be the first – and most aesthetically appealing – choice. (Pictured: FSB 13 4256 sliding door handle)

Project: Family home, Gütersloh
Architectural firm: Heitmann Architekten



- 542 Fittings for sliding doors
- 550 Sliding door handles
- 569 Technical information

Fittings for sliding doors

Added value at a glance

Sliding doors are currently undergoing a veritable renaissance. In select residential properties, they engender a sense of luxurious minimalism and spacious living. The efficient use of space they afford can benefit smaller commercial properties as well. Sliding doors connect rooms in a flexible and especially inviting way. FSB has come up with a new range of sliding door

handles that offer a compelling combination of design and function in equal measure. A large selection of round and angular variants is available in a number of individual colour combinations. The innovative operating concept combines the locking, opening and sliding functions in a single element.

Different designs in angular or round shapes

Variants with locking function for bathroom and WC doors

Diverse materials and finishes in aluminium, stainless steel and bronze for continuity of design when combining with any FSB door or window handle

Concealed fixing for optimal aesthetics without screws

Integration in any interior design concept thanks to versatile design, material and finish options

Suitable for single and double-leaf sliding doors



Simple and tool-free installation: the area or frame is cut out and the handle is simply pressed into place.

In the case of flush timber doors, the handle is surface-mounted so as to hide any unty-routed edges.

Innovative operating concept for locking, opening and sliding

Installation depth of just 12.5 mm allows for use in pairs, including with a lock on standard 38 mm thick doors. Very thin sliding doors at least 25 mm thick can be used in pairs without a lock.

Flush-fitted installation to squeeze sliding door into narrow wall recesses

Click-stop mechanism for handles with twist thumb turn: thumb turn always sits in a precisely vertical position.

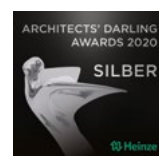

7a

Fittings for sliding doors

Product variants

Product features of sliding door handles

- For single and double-leaf sliding doors
- Concealed fixing
- Round, oval and angular variants
- Different shapes with open or enclosed recess
- Tool-free installation

Sliding door handles oval and rectangular



- Open, enclosed and semi-enclosed variants
- Suitable routing jig available

Sliding door handles round and square



- Open, enclosed and semi-enclosed variants
- Suitable routing jig available

Sliding door handles for bathroom and WC



- Enclosed variant
- With sliding-door mortice lock
- Suitable for standard door thicknesses of 38–42 mm; available up to door thickness 62 mm

Product features of sliding door handles with gripping device

- For single and double-leaf sliding doors
- Consisting of three components: shell, grip/thumb turn, faceplate
- Faceplate can be designed to match the door finish
- Diverse shapes and colours available
- Innovative operating concept: locking, opening and closing functions in a single element
- Improved ergonomics: gripping device tilts by 18° when operated
- Tool-free installation

Sliding door handles angular with gripping device



- Lockable (with twist thumb turn) and non-lockable variants
- Option of profile cylinder (PC) keyway
- Gripping device tilts in both directions

Sliding door handles round and square with gripping device



- Lockable (with twist thumb turn) and non-lockable variants
- Gripping device tilts in both directions

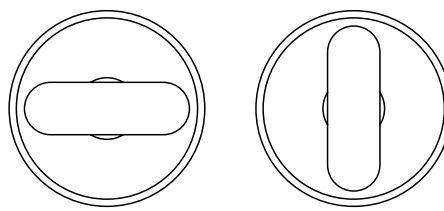

locked

unlocked

Sliding door handles round with round gripping device



- Not lockable
- Fixed gripping device, tilts

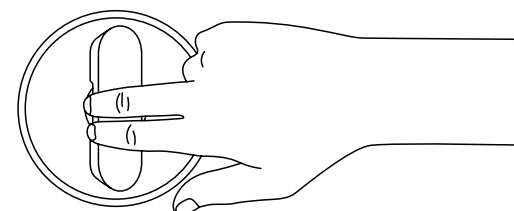



slide/open

7a

Fittings for sliding doors

Overview

Sliding door handles

42 4211 
42 4212 
Page 562



42 4250 
Page 550

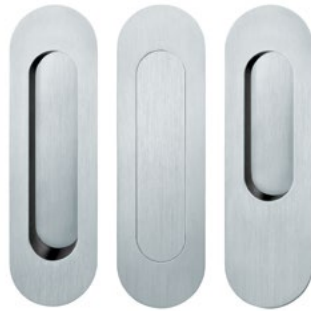

42 4251 
Page 551



42 4252 
Page 552



42 4253 
Page 553

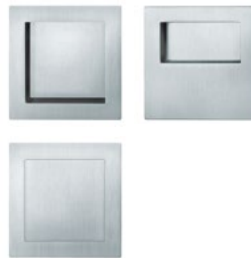

42 4254 
Page 552



42 4255 
Page 552 f.



42 4255 
Page 556



42 4255 
Page 559 f.



Sliding door handles

with gripping device

42 4260 ■ ■
Page 563



42 4261 ■ ■
Page 563



42 4262 ■ ■
Page 564



42 4263 ■ ■
Page 564



42 4264 ■ ■
Page 565



42 4265 ■ ■
Page 565



7a

Fittings for sliding doors

Oval sliding door handles

- Aluminium
- Stainless steel
- Bronze

42 4250

For single and double-leaf sliding doors

42 4250 00000 (open)*

42 4250 00001 (enclosed)

42 4250 00002 (semi-enclosed)

Recess 150 × R20 × 17.5 mm

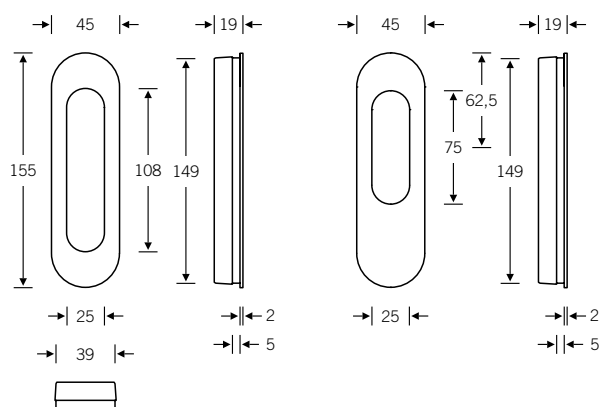

* 42 4250 00000 also available in bronze

For FSB routing jig 03 0462 00020 9600 for mechanically routing the recess for FSB sliding door handles, see page 780

Fittings for sliding doors

Rectangular sliding door handles

■ Aluminium
■ Stainless steel
■ Bronze

42 4251 ■ ■ ■

For single and double-leaf sliding doors

42 4251 00000 (open)*
 42 4251 00001 (enclosed)
 42 4251 00002 (semi-enclosed)

Recess 150 × R 20 × 17.5 mm

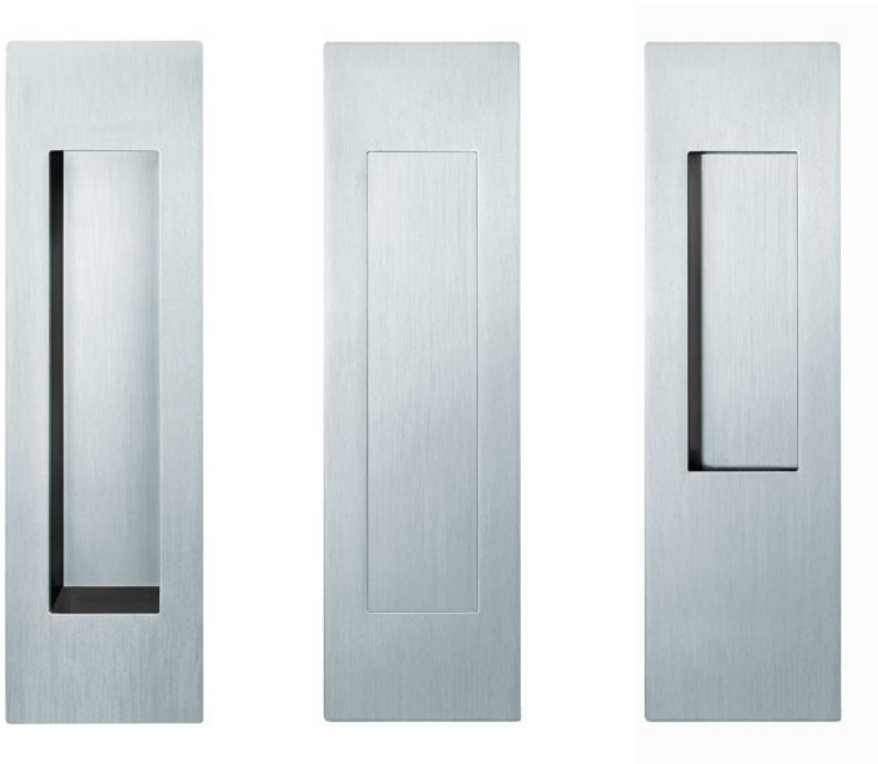

7a

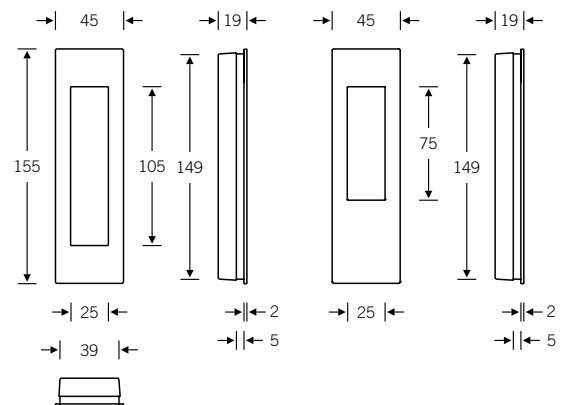

* 42 4251 00000 also available in bronze

For FSB routing jig 03 0462 00020 9600 for mechanically routing the recess for FSB sliding door handles, see page 780

Fittings for sliding doors

Round sliding door handles

■ Aluminium
■ Stainless steel
■ Bronze

42 4252 ■ ■

For single and double-leaf sliding doors

42 4252 00000 (open)
 42 4252 00001 (enclosed)
 42 4252 00002 (semi-enclosed)

Recess $\varnothing 70 \times 17.5$ mm

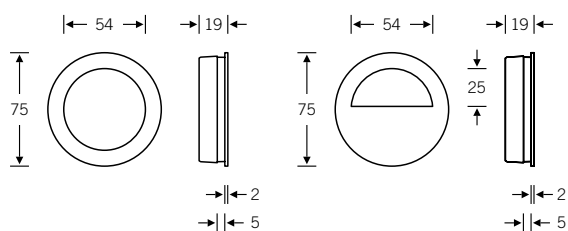

42 4254 ■ ■

For single and double-leaf sliding doors

42 4254 00000 (open)
 42 4254 00001 (enclosed)

Recess $\varnothing 45 \times 17.5$ mm

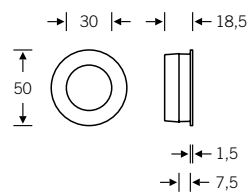
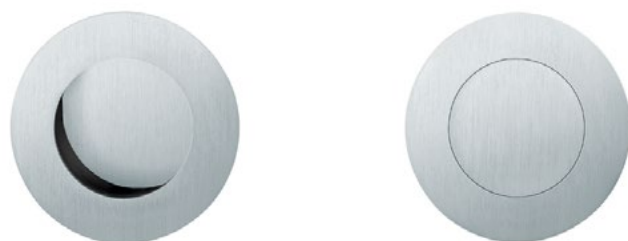

For FSB routing jig 03 0462 00020 9600 for mechanically routing the recess for FSB sliding door handles, see page 780

Fittings for sliding doors

Square sliding door handles

■ Aluminium
■ Stainless steel
■ Bronze

42 4253 ■ ■

For single and double-leaf sliding doors

- 42 4253 00000 (open)
- 42 4253 00001 (enclosed)
- 42 4253 00002 (semi-enclosed)

Recess 65 × 65 × 17.5 mm
 Corner radius R 15

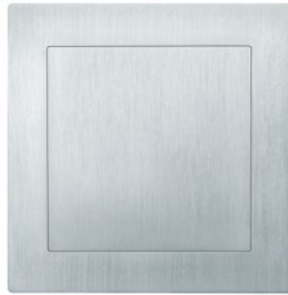
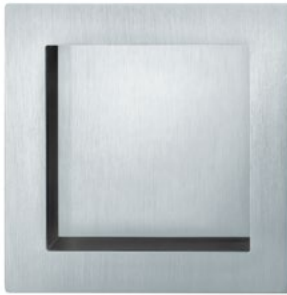

7a

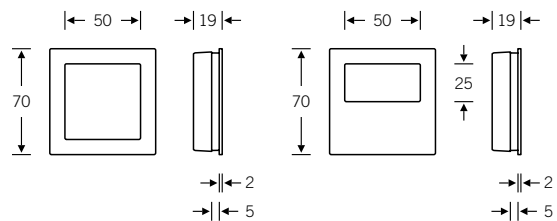

For FSB routing jig 03 0462 00020 9600 for mechanically routing the recess for FSB sliding door handles, see page 780

Fittings for sliding doors

Sliding door handle with warded lock (WL) keyway

- Aluminium
- Stainless steel
- Bronze

42 4255 ■

For single-leaf sliding doors

42 4255 09002
Set with sliding-door mortice lock series 71/WL

42 4255 09003
Set with sliding-door mortice lock series 72/WL

Suitable for door thicknesses of 42 – 44 mm
Stainless steel forend

Scope of delivery:

- Set
- Sliding-door mortice lock series 71/WL or 72/WL
- Strike plate
- Folding key



Outside

Inside

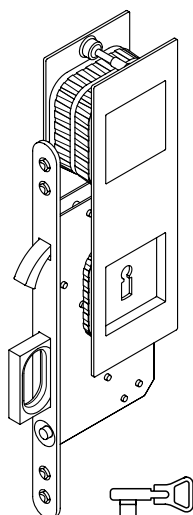

42 4255
Key

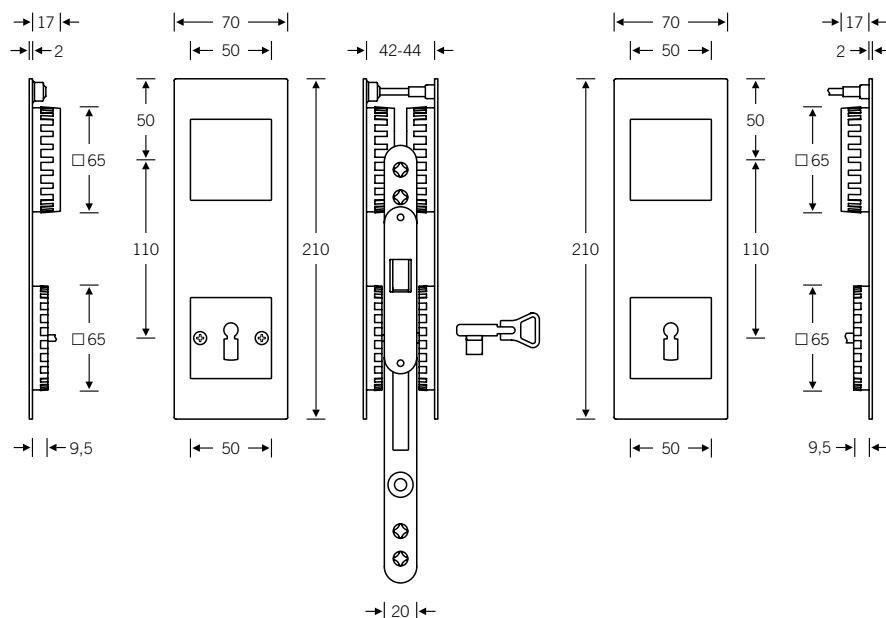

Note: CNC machining is required for routing recesses; CNC routing details can be found at www.fsb.de/cnc

Fittings for sliding doors

Sliding door handle with profile cylinder (PC) keyway

- Aluminium
- Stainless steel
- Bronze

42 4255 ■

For single-leaf sliding doors

42 4255 09004
Set with sliding-door mortice lock series 71/PC

42 4255 09005
Set with sliding-door mortice lock series 72/PC

FSB recommendation: only suitable for door thickness of 55 mm upwards

Note: if the door is intended to move completely into the door casing, adapt the cylinder length to the door thickness.

Stainless steel forend and strike plate

Scope of delivery:

- Set
- Sliding-door mortice lock series 71/PC or 72/PC
- Strike plate

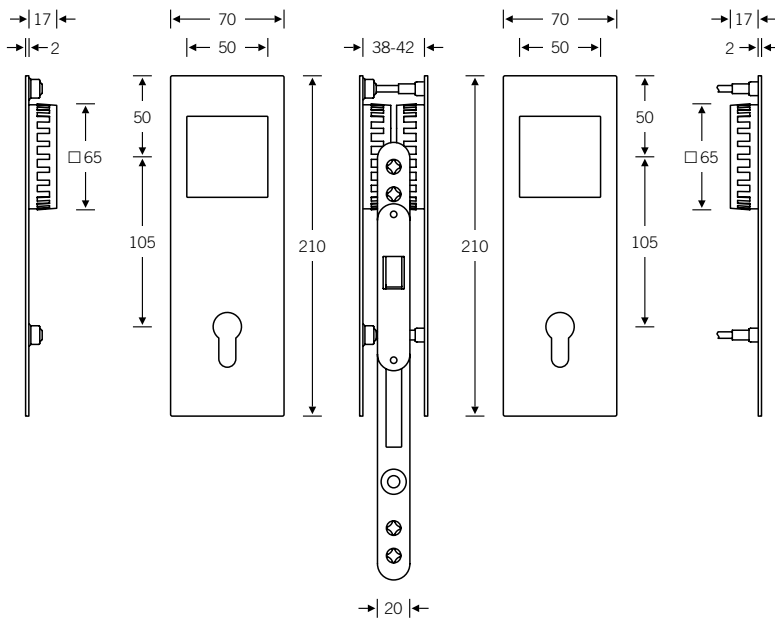
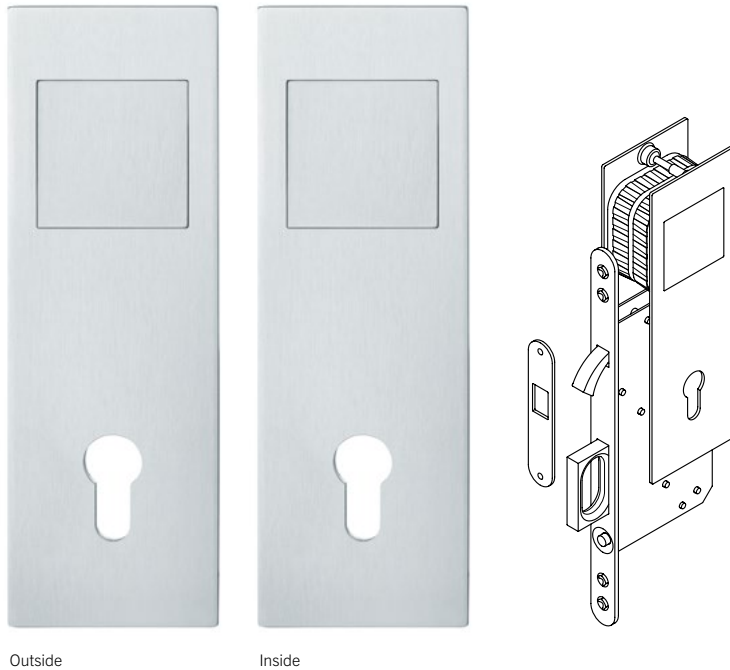

7a

Note: CNC machining is required for routing recesses; CNC routing details can be found at www.fsb.de/cnc

Fittings for sliding doors

Sliding door handle without keyway

- Aluminium
- Stainless steel
- Bronze

42 4255 ■

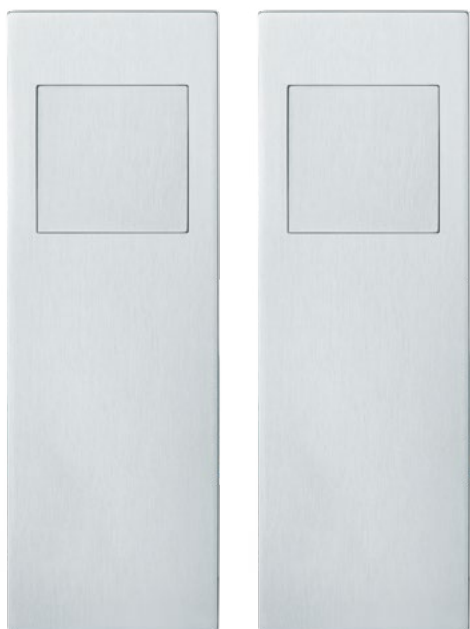

Outside

Inside

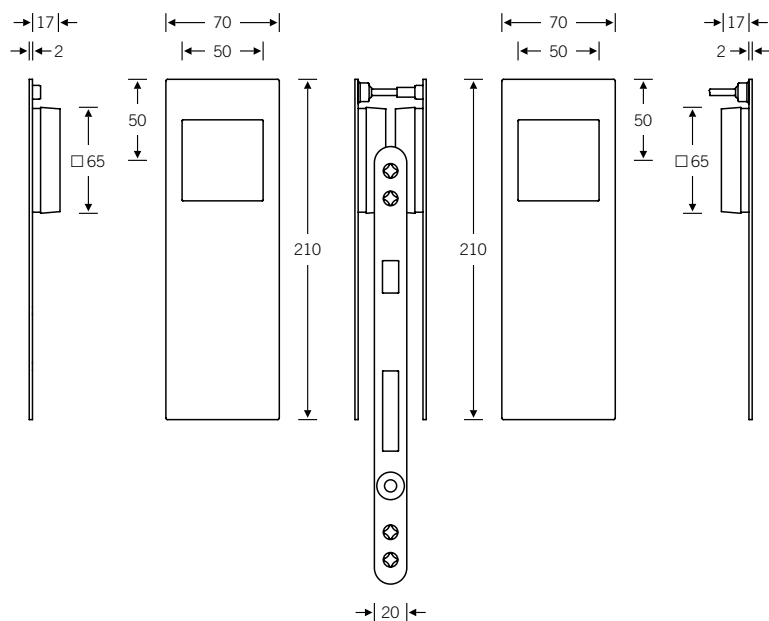

For double-leaf sliding doors

42 4255 09006

Set with mortise strike box series 72 GK (with spring pull)

For use on double-leaf sliding doors, FSB 42 4255 09008 is also required (see page 558).

Suitable for standard door thicknesses of 38–42 mm; available up to door thickness 62 mm
Stainless steel forend

Scope of delivery:

- Set
- Mortise strike box Series 72 GK

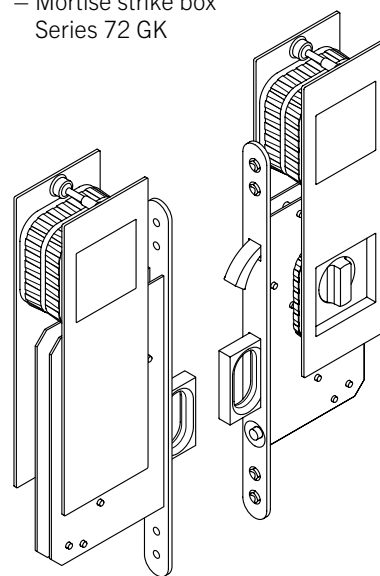

42 4255 09006

42 4255 09008 (must be ordered separately; see page 554)

Note: CNC machining is required for routing recesses; CNC routing details can be found at www.fsb.de/cnc

Fittings for sliding doors

Sliding door handle for bathroom and WC

- Aluminium
- Stainless steel
- Bronze

42 4255 ■

For single and double-leaf sliding doors

42 4255 09007

Set with sliding-door mortice lock series 71/WC (with compass bolt)

For use on double-leaf sliding doors, FSB 42 4255 09006 is also required (see page 556).

Suitable for standard door thicknesses of 38–42 mm; available up to door thickness 62 mm
Stainless steel forend and strike plate

Scope of delivery:

- Set
- Sliding-door mortice lock Series 71/WC
- Strike plate



Outside

Inside

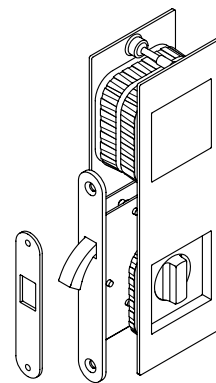

Pictured: installation example for single-leaf sliding door

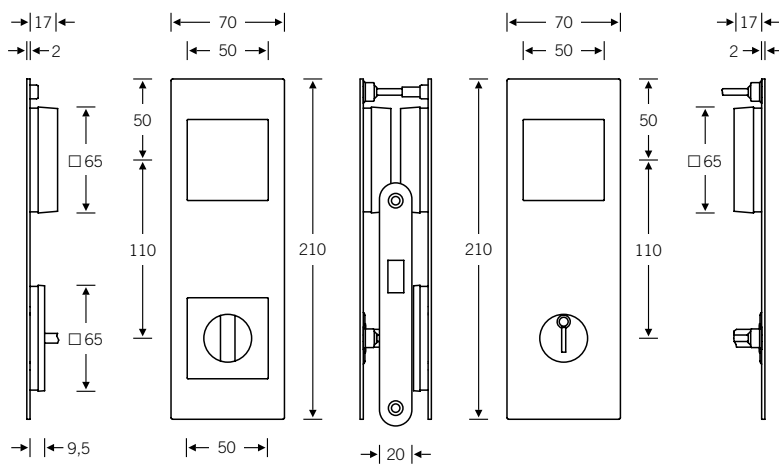

Note: CNC machining is required for routing recesses; CNC routing details can be found at www.fsb.de/cnc

Fittings for sliding doors

Sliding door handle for bathroom and WC

- Aluminium
- Stainless steel
- Bronze

42 4255 ■

For single and double-leaf sliding doors

42 4255 09008

Set with sliding-door mortice lock series 72/WC (with compass bolt and spring pull)

For use on double-leaf sliding doors, FSB 42 4255 09006 is also required (see page 556).

Suitable for standard door thicknesses of 38–42 mm; available up to door thickness 62 mm
Stainless steel forend and strike plate

Scope of delivery:

- Set
- Sliding-door mortice lock Series 72/WC
- Strike plate

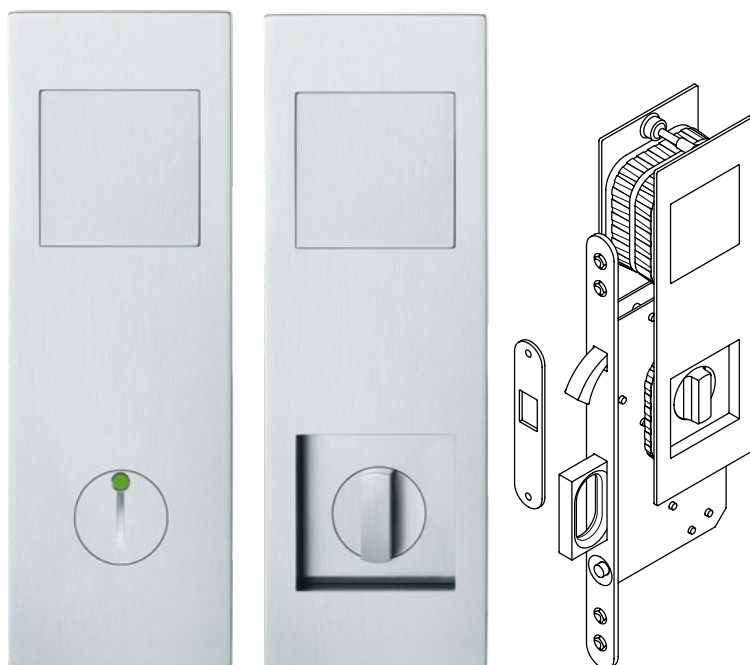

Outside

Inside

Pictured: installation example for single-leaf sliding door

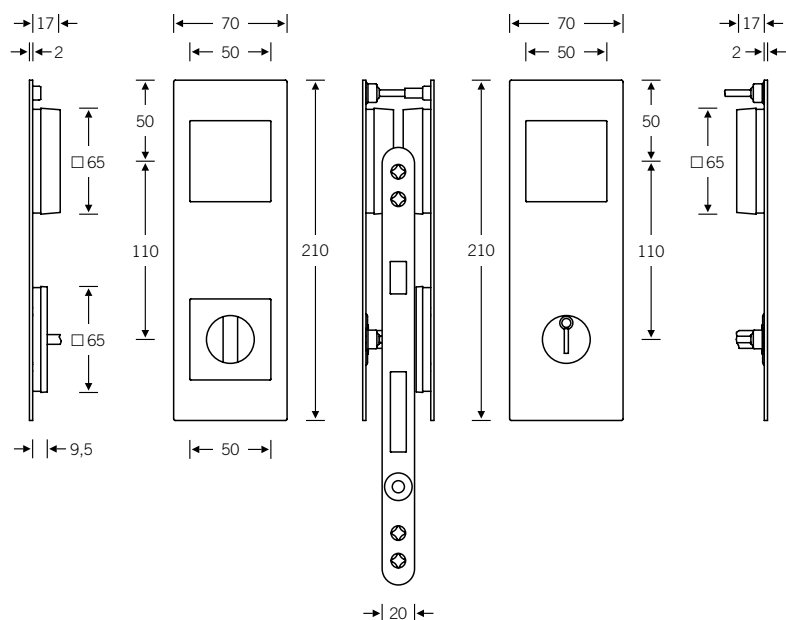

Note: CNC machining is required for routing recesses; CNC routing details can be found at www.fsb.de/cnc

Fittings for sliding doors

Sliding-door mortice lock

- Aluminium
- Stainless steel
- Bronze

Series 71/WC

Sliding-door mortice lock grade 3

Round flat forend
 Polished stainless steel forend
 Nickel-plated compass bolt

Sliding-door mortice lock and strike plate included in scope of delivery for FSB 42 4255 09007

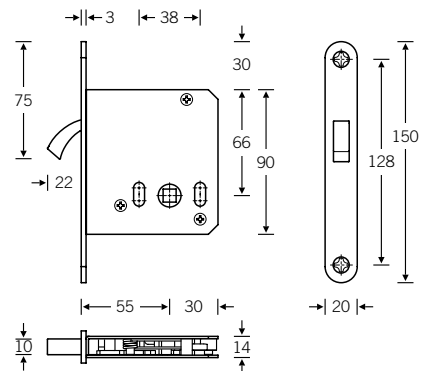

Strike plate

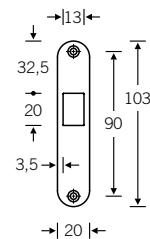

7a

Fittings for sliding doors

Sliding-door mortice lock

- Aluminium
- Stainless steel
- Bronze

Series 72/WC

Sliding-door mortice lock grade 3

Round flat forend
 Polished stainless steel forend
 Nickel-plated spring pull, compass bolt
 and push-button

Sliding-door mortice lock and strike
 plate included in scope of delivery for
 FSB 42 4255 09008

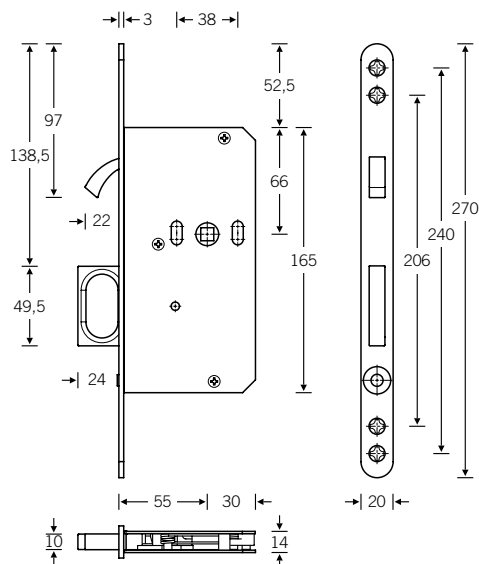

Strike plate

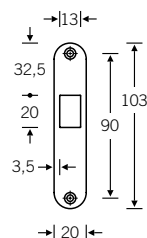

Sliding-door mortice locks and strike
 plates are not available from FSB as
 individual parts

Fittings for sliding doors

Mortise strike box

- Aluminium
- Stainless steel
- Bronze

Series 72 GK

Mortise strike box for sliding-door mortise lock series 72/WC

Polished stainless steel forend
Nickel-plated spring pull and push-button

Mortise strike box included in scope of delivery for FSB 42 4255 09006

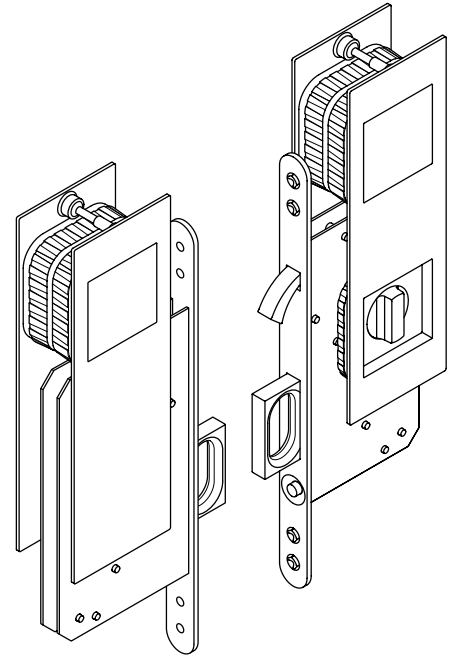

Pictured:
installation example
for double-leaf sliding door

7a

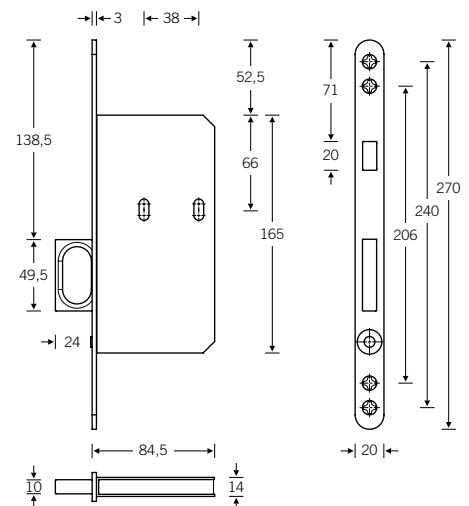

Sliding-door mortise locks and strike plates are not available from FSB as individual parts

Fittings for sliding doors

Sliding door handles with visible fixing

- Aluminium
- Stainless steel
- Bronze



42 4211   

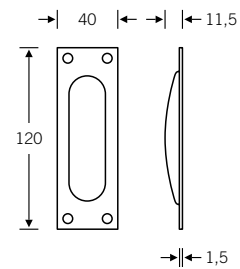

Recess $87 \times 28 \times 10$ mm
Drill hole for countersunk screws $\varnothing 2.9$ mm

Can be supplied with warded lock (WL),
profile cylinder (PC) keyways or without
keyway



42 4212  



Recess $87 \times 28 \times 10$ mm
Drill hole for countersunk screws $\varnothing 2.9$ mm

Can be supplied with warded lock (WL),
profile cylinder (PC) keyways or without
keyway

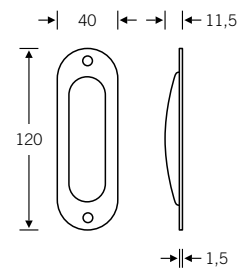

Fittings for sliding doors

Angular sliding door handles with gripping device

- Aluminium
- Stainless steel
- Bronze

42 4260 



For single and double-leaf sliding doors

00000 (not lockable)
Fixed gripping device, tilts in both directions

Recess $163 \times 65 \times 12.5$ mm

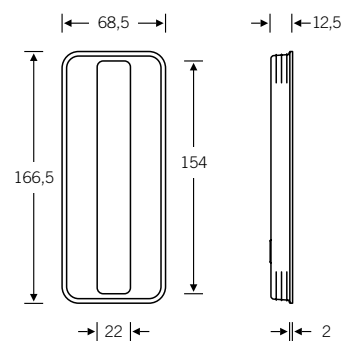

42 4261 



For single and double-leaf sliding doors*

00010 (lockable)
Fixed gripping device, tilts in both directions,
for compass bolt lock with profile cylinder
(PC) keyway (door thickness 55 mm
upwards)

Recess $163 \times 65 \times 12.5$ mm

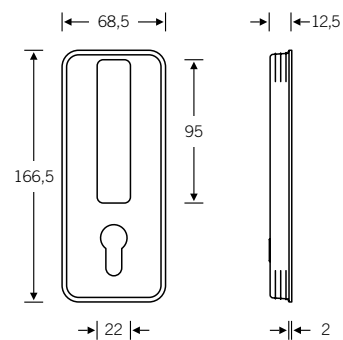

Design: Michael Schmidt

Note: the pictures shown here are for reference only; the actual product may differ.

* For double-leaf sliding doors in combination with FSB 42 4260

7a

Fittings for sliding doors

Angular sliding door handles with gripping device

- Aluminium
- Stainless steel
- Bronze

42 4262



For single and double-leaf sliding doors*

00008 (lockable)

Fixed gripping device (top), tilts in both directions, twist thumb turn (bottom), for compass bolt lock

Recess 163 × 65 × 12.5 mm

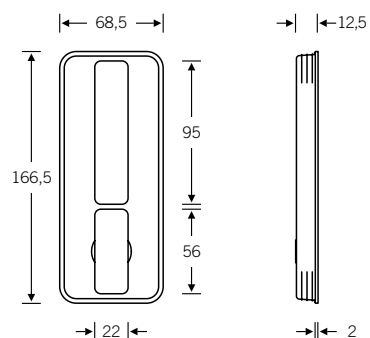

42 4263



For single and double-leaf sliding doors**

00000 (not lockable)

Fixed gripping device, tilts in both directions

01008 (lockable)

Twist gripping device, tilts in both directions, for compass bolt lock

Recess: 80 × 80 mm × 12.5 mm

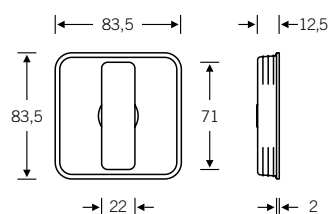

Design: Michael Schmidt

Note: the pictures shown here are for reference only; the actual product may differ.

* For double-leaf sliding doors in combination with FSB 42 4260

** For double-leaf sliding doors: combination of FSB 42 4263 00000 and FSB 42 4263 01008

Fittings for sliding doors

Round sliding door handles with gripping device

- Aluminium
- Stainless steel
- Bronze

42 4264



For single and double-leaf sliding doors*

00000 (not lockable)
Fixed gripping device, tilts in both directions

01008 (lockable)
Twist gripping device, tilts in both directions,
for compass bolt lock

Recess: \varnothing 80 mm \times 12.5 mm

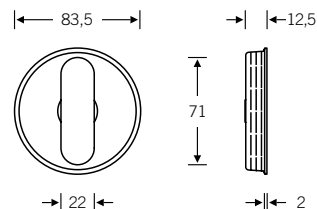

42 4265



Pictured: right-hand model

For single and double-leaf sliding doors

00004 (right, not lockable)
00005 (left, not lockable)
Round fixed gripping device, tilts

Recess: \varnothing 80 mm \times 12.5 mm

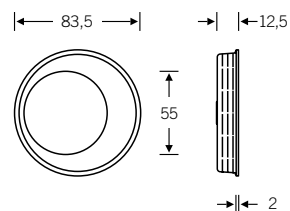

7a

Design: Michael Schmidt







Note: the pictures shown here are for reference only; the actual product may differ.

* For double-leaf sliding doors:
combination of FSB 42 4264 00000
and FSB 42 4264 01008

Fittings for sliding doors

Colour combinations

The configuration of our new sliding door handles 42 4260 – 42 4265 is such that the faceplate can be custom-designed so as to acquire a timber look finish to match the face of the door, for instance. FSB will be pleased to provide you with CAD data for the purpose of planning the faceplate.

| | Angular/round shell (metal) | Faceplate (metal) | FSB colour code |
|------------------------------------------------------------------------------------|-------------------------------------------------|-------------------------------------------------------|------------------------|
|  | Blasted aluminium natural colour, anodised | Polished aluminium natural colour, anodised (0105) | 1100 |
|  | | Blasted aluminium black, anodised (0810) | 1102 |
|  | Blasted aluminium black, anodised (0810) | Polished aluminium natural colour, anodised (0105) | 1115 |
|  | | Blasted aluminium black, anodised (0810) | 1117 |
|  | | Dark bronze, patinated and waxed (7625) | 1119 |
|  | Powder-coated aluminium white matt, RAL 9016 | Powder-coated aluminium white matt, RAL 9016 | 8252 |
|  | Stainless Steel, brushed satin matt (6204) | Stainless Steel, brushed satin matt (6204) | 6443 |

Further colour combinations available upon request

Note: the pictures shown here are for reference only; the actual product may differ.

569 **Technical information**
Fittings for sliding doors

Technical information

Routing dimensions for sliding door handles

42 4250

42 4250 00000 (open)
 42 4250 00001 (enclosed)
 42 4250 00002 (semi-enclosed)

Recess for surface-mounted installation:
 150 × R 20 × 17.5 mm

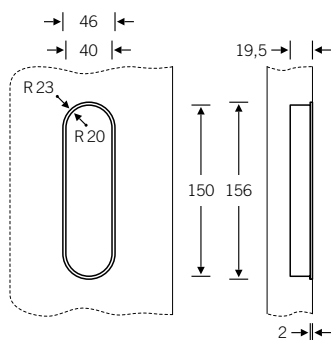

42 4251

42 4251 00000 (open)
 42 4251 00001 (enclosed)
 42 4251 00002 (semi-enclosed)

Recess for surface-mounted installation:
 150 × R 20 × 17.5 mm

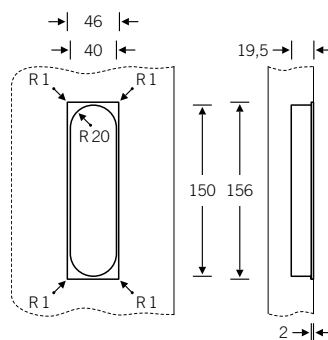

42 4252

42 4252 00000 (open)
 42 4252 00001 (enclosed)
 42 4252 00002 (semi-enclosed)

Recess for surface-mounted installation:
 Ø 70 × 17.5 mm

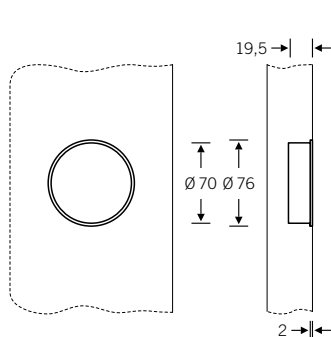

42 4253

42 4253 00000 (open)
 42 4253 00001 (enclosed)
 42 4253 00002 (semi-enclosed)

Recess for surface-mounted installation:
 65 × 65 × 17.5 mm
 Corner radius R 15

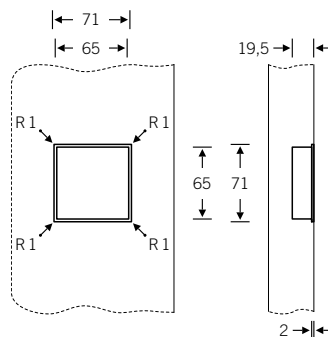

42 4254

42 4254 00000 (open)
 42 4254 00001 (enclosed)

Recess for surface-mounted installation:
 Ø 45 × 17.5 mm

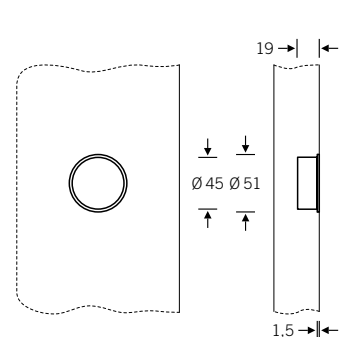

We recommend doing making test cuts during routing in order to check the precise fit of the sliding door handles individually.

For suitable routing jig 03 0462 00020, see page 780

Technical information

Routing dimensions for sliding door handles

42 4255

42 4255 09002
Set with sliding-door mortice lock
series 71/WL
Minimum door thickness 42 mm

42 4255 09003
Set with sliding-door mortice lock
series 72/WL
Minimum door thickness 42 mm

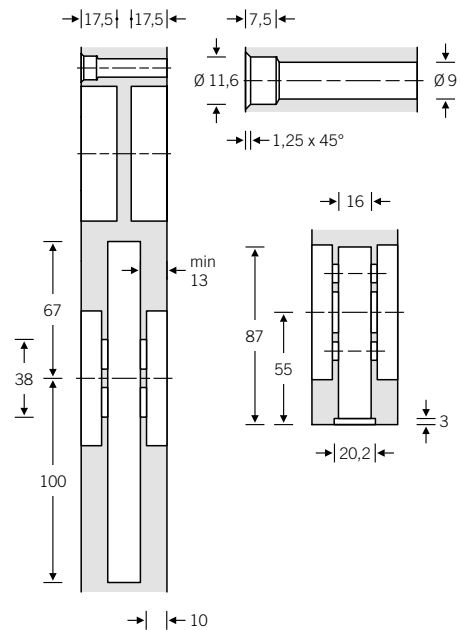
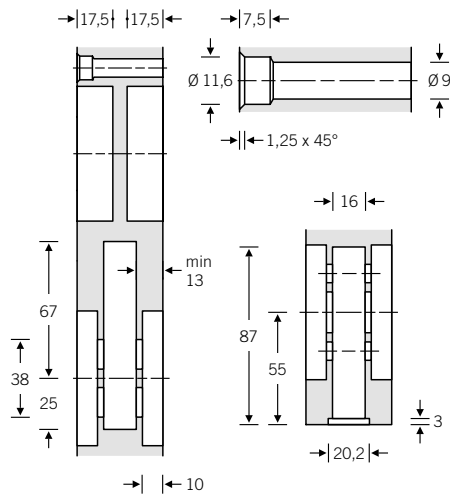
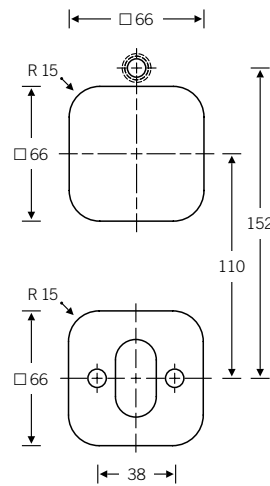
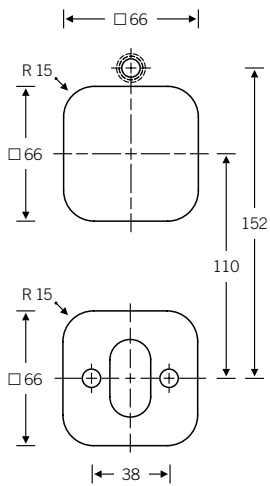

CNC routing details can be downloaded
from: www.fsb.de/cnc

Technical information

Routing dimensions for sliding door handles

42 4255

42 4255 09004
Set with sliding-door mortice
lock series 71/PC
Minimum door thickness 38 mm

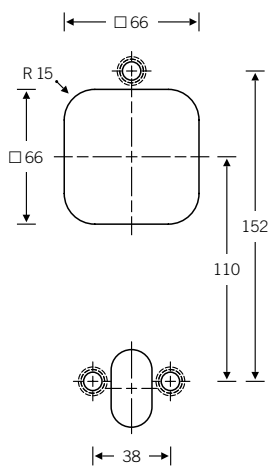

42 4255 09005
Set with sliding-door mortice
lock series 72/PC
Minimum door thickness 38 mm

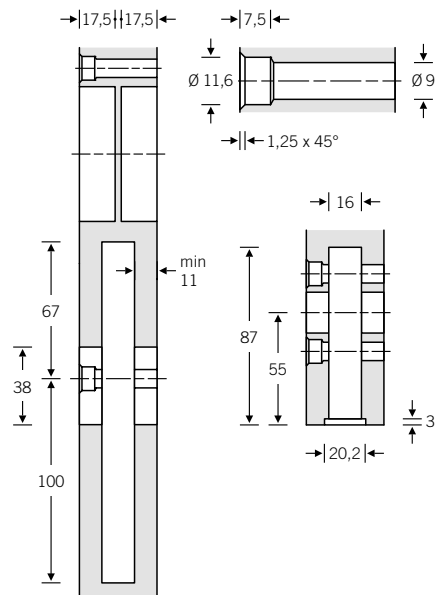
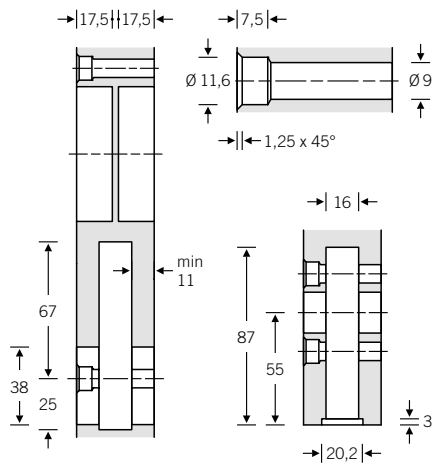
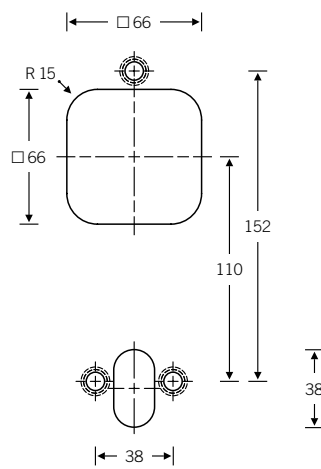

CNC routing details can be downloaded
from: www.fsb.de/cnc

Technical information

Routing dimensions for sliding door handles

42 4255

42 4255 09006
Set with mortise strike box
series 72 GK
Minimum door thickness 38 mm

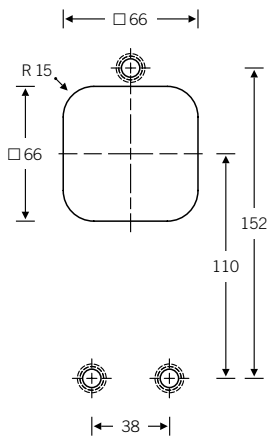

42 4255 09007
Set with sliding-door mortise lock
series 71/WC
Minimum door thickness 38 mm

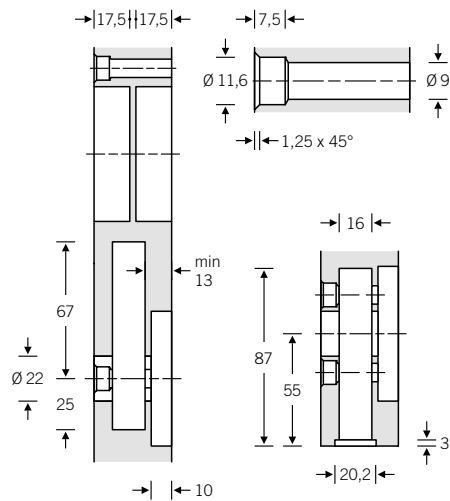
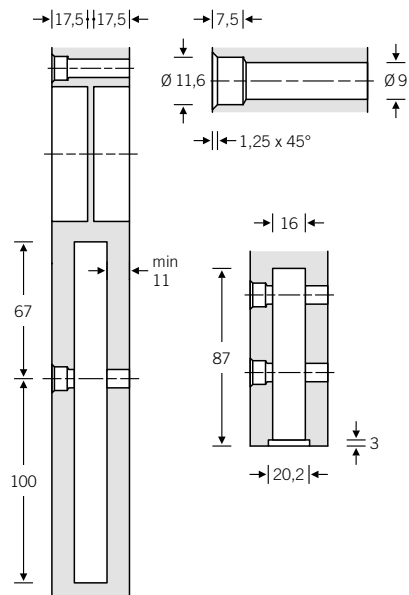
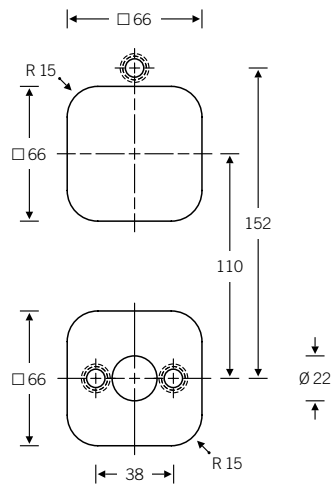

CNC routing details can be downloaded
from: www.fsb.de/cnc

Technical information

Routing dimensions for sliding door handles

42 4255

42 4255 09008

Set with sliding-door mortice lock
series 72/WC

Minimum door thickness 38 mm

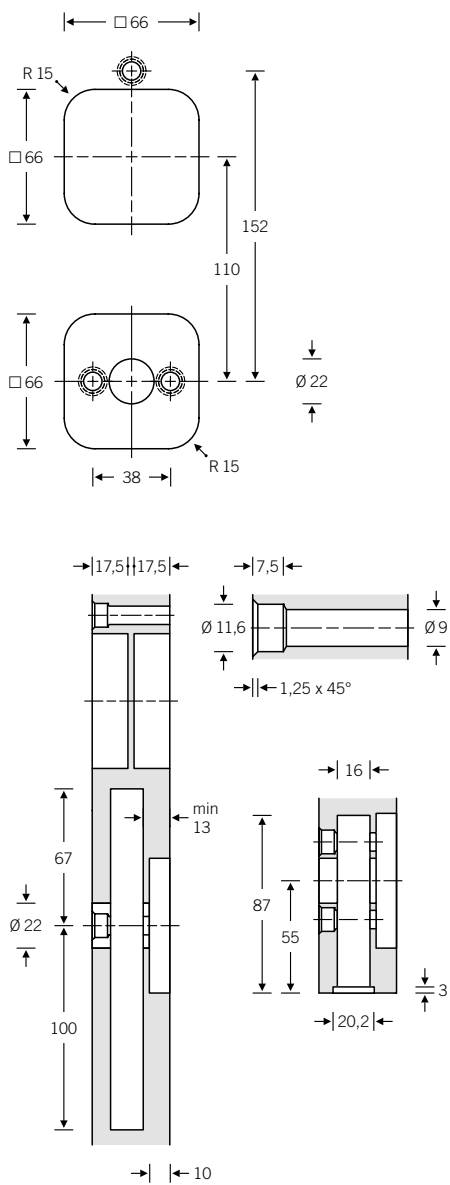

CNC routing details can be downloaded
from: www.fsb.de/cnc

Technical information

Routing dimensions for sliding door handles

42 4260

42 4260 00000 (not lockable,
fixed gripping device)

Recess for surface-mounted installation:
163 × 65 × 12.5 mm

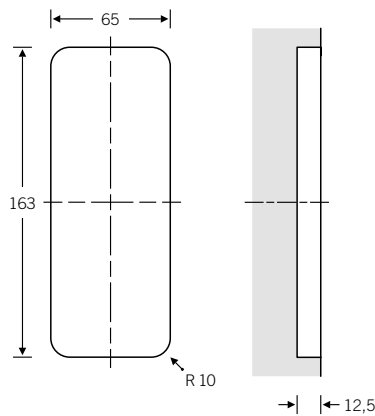

42 4261

42 4261 00010 (lockable,
fixed gripping device,
profile cylinder (PC)
keyway)

Recess for surface-mounted installation:
163 × 65 × 12.5 mm

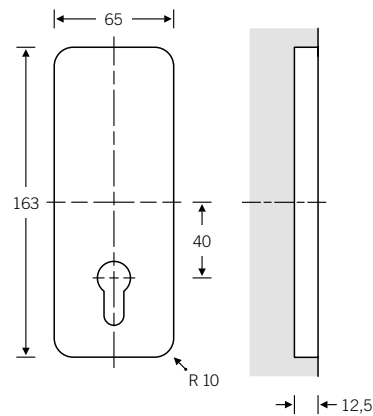

42 4262

42 4262 00008 (lockable,
fixed gripping device on
top, twist thumb turn on
bottom)

Recess for surface-mounted installation:
163 × 65 × 12.5 mm

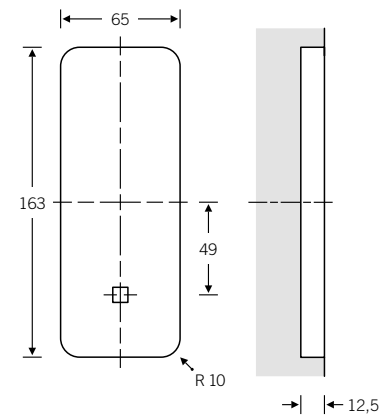

42 4263

42 4263 00000 (not lockable,
fixed gripping device)
42 4263 01008 (lockable,
twist gripping device)

Recess for surface-mounted installation:
80 × 80 × 12.5 mm

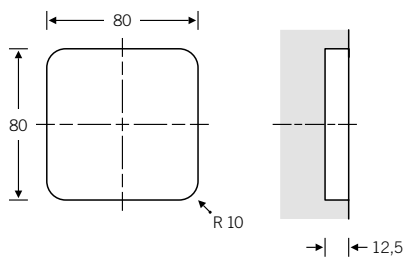

42 4264 | 42 4265

42 4264 00000 (not lockable,
fixed gripping device)
42 4264 01008 (lockable,
twist gripping device)
42 4265 00000 (not lockable,
round fixed gripping
device)

Recess for surface-mounted installation:
∅ 80 × 12.5 mm

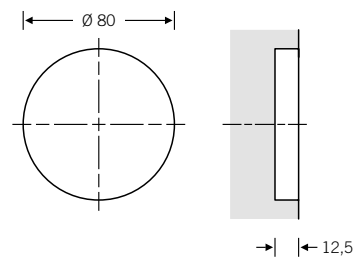

For suitable routing jig 03 0462 00050,
see page 781

7a



576 Recessed lever handles

586 Flush ring handles

Recessed lever handles

Added value at a glance

FSB sets precedents. In certain installation situations, door handles are not allowed to protrude beyond the face of the door, as in the case of sliding doors or gymnasium doors. To address this need, FSB developed recessed lever handles. Standard quality features such as robust functionality even under extreme conditions of use come together here with absolute precision.

Meets German Social Accident Insurance (DGUV) requirements and approved under EN 179 and DIN 18273

2 mm edge radii to prevent injury in accordance with DGUV requirements

Generous gripping space behind the lever handle pursuant to EN 179

Profile cylinder (PC) and blank keyways can be combined





EN 179 lever handle with its return to the flush pull and generous curvature reduces the risk of hands getting caught or pinched

Suitable for sliding door systems or gymnasium doors (handle does not protrude beyond the face of the door)

Opposite face fitted with FSB AGL® rose/backplate half-set

Range includes additional recessed lever handles for up-and-over doors as well as flush ring handles

Section 11(1) of the regulations of the German Social Accident Insurance (DGUV), 'Fixtures and fittings', stipulates that, in 'areas of occupancy' (these being areas in schools and nursery schools that are 'intended to be accessible to children'), 'edges, corners and hooks on fixtures and fittings [...], up to a height of 2 m from floor level, are to be so designed or made safe that the risk of injury [to the children] is avoided.' Injury avoidance is to be ensured by means of a minimum radius of 2 mm or by chamfering all corners and edges – and this also applies to door fittings.

7b

Recessed lever handles

Overview

■ Aluminium
■ Stainless steel
■ Bronze

77 7947 ■
Page 582



77 7948 ■
Page 583



77 7949 ■
Page 584



77 7950 | 77 7952 ■ ■
77 7954 ■
Page 585



42 4203 | 42 4204 ■ ■
Page 587



42 4205 ■
Page 588



Recessed lever handles for up-and-over doors

- Aluminium
- Stainless steel
- Bronze

77 7947 ■



9 mm square spindle

Profile cylinder (PC) 60 mm and blank
keyways
Installation depth 23 mm
Frame height 25 mm

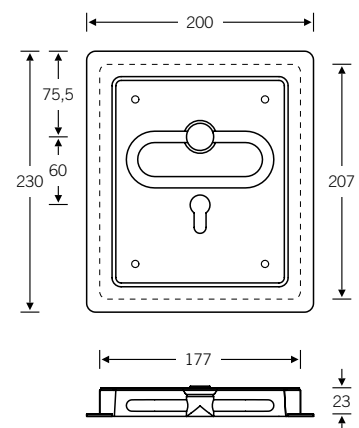

- FSB ASL®
 - FSB AGL®
 - FS heavy-duty fitting
 - EN 179 heavy-duty fitting
- For bearings, see page 52 ff.

Recessed lever handles

conforming to EN 179 and DGUV

- Aluminium
- Stainless steel
- Bronze

77 7948 ■



🔑 9 mm square spindle

Profile cylinder (PC) and blank keyways
(for EN 179 inactive leaf)
Centres 72 + 92 mm
Installation depth 40 mm
Frame height 45 mm

For combination on opposite face with
FSB AGL® rose or backplate half-set,
turnably fixed variant (must be ordered
separately)

FSB door handle models, DGUV-approved
throughout Germany; see page 75

Main benefits at a glance:

- Generous gripping space behind the door handle pursuant to EN 179
- 2 mm edge radii to prevent injury in accordance with DGUV requirements
- EN 179 lever handle with its return-to-door and generous curvature reduces the risk of hands getting caught or pinched

Pictured: right-hand model

Backplate variant for
PC 72

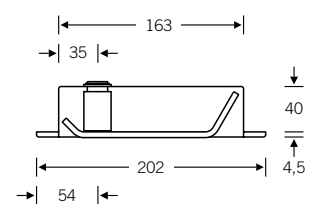
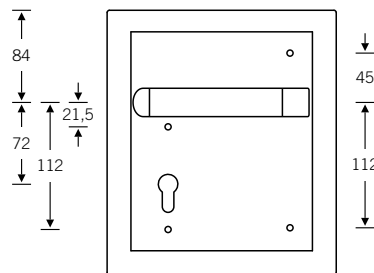

Rose variant for
PC 72 and 92 mm

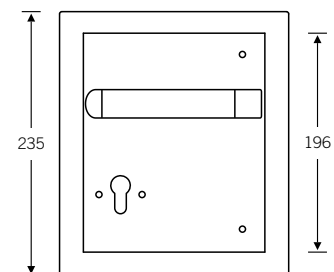
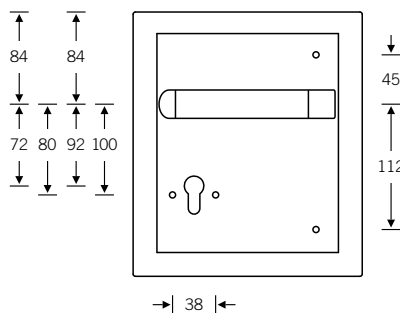

7b

To prevent any risk of injury, please ensure there is sufficient backset when fitting the handle and that the rim fits flush with the door.

Order details required:

- Backplate/rose
- DIN handing
- Keyway
- Centres
- Door thickness

- 🔑 FSB ASL®
 - 🔑 FSB AGL®
 - 🔑 FS heavy-duty fitting
 - 🔑 EN 179 heavy-duty fitting
- For bearings, see page 52 ff.

Recessed lever handles with reduced depth

- Aluminium
- Stainless steel
- Bronze

77 7949 ■



- ⊕ 8 mm square spindle
- ⊕ 9 mm square spindle

Profile cylinder (PC) and blank keyways
Centres 72 + 92 mm
Installation depth 23 mm
Frame height 25 mm

For combination on opposite face with
FSB AGL® rose or backplate half-set,
turnably fixed variant (must be ordered
separately)

In the case of back-to-back installation,
please keep the door thickness in mind

Main benefits at a glance:

- Recessed lever handle with reduced depth
- Features straight mitred corners

Pictured: right-hand model

Backplate variant for
PC 72 and 92 mm

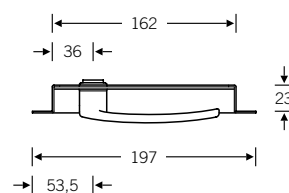
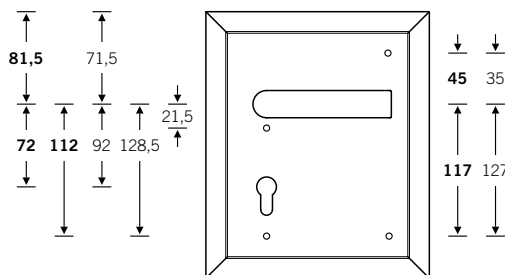

Rose variant for
PC 72 and 92 mm

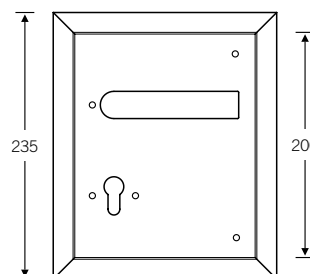
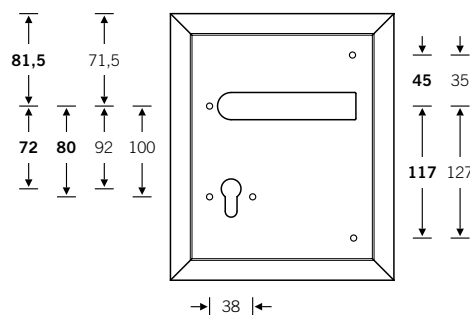

To prevent any risk of injury, please ensure
there is sufficient backset when fitting the
handle and that the rim fits flush with the
door.

Order details required:

- Backplate/rose
- DIN handing
- Spindle 8 or 9 mm
- Keyway
- Centres
- Door thickness

- ⊕ FSB ASL®
 - ⊕ FSB AGL®
 - ⊕ FS heavy-duty fitting
 - ⊕ EN 179 heavy-duty fitting
- For bearings, see page 52 ff.

Recessed lever handles

With corner radius 8 mm

- Aluminium
- Stainless steel
- Bronze

77 7950 | 77 7952 ■ ■
77 7954 ■



- ⊕ 8 mm square spindle
- ⊕ 9 mm square spindle (FS in stainless steel only)

Profile cylinder (PC) and blank keyways
Centres 72 + 92 mm
Installation depth 23 mm
Frame height 25 mm

For combination on opposite face with FSB AGL® rose or backplate half-set, turnably fixed variant (must be ordered separately)

Corner radius 8 mm

In the case of backplate variant PC 92 mm, through-fixing is only possible underneath the handle bushing.

Pictured: right-hand model

77 7950
Backplate variant for
PC 72 and 92 mm

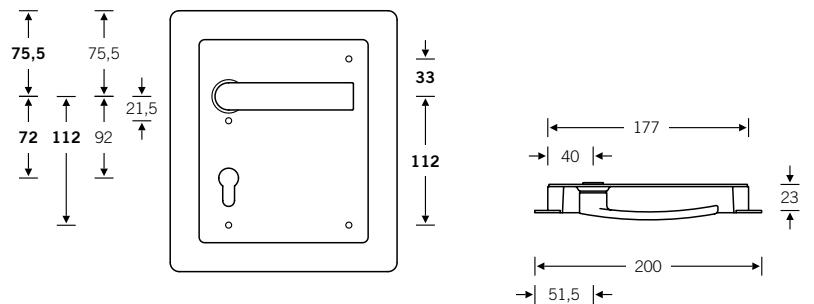

77 7952
Rose variant for
PC 72 and 92 mm

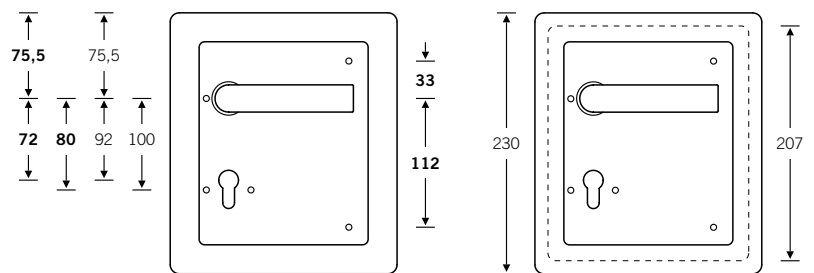

77 7954
Rose variant
without PC keyway for inactive leaf

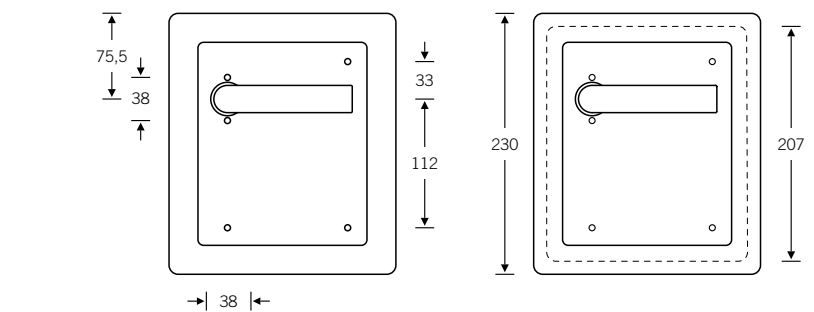

To prevent any risk of injury, please ensure there is sufficient backset when fitting the handle and that the rim fits flush with the door.

Order details required:

- Backplate/rose
- DIN handing
- Spindle 8 or 9 mm
- Keyway
- Centres
- Door thickness

- ⊕ FSB ASL®
 - ⊕ FSB AGL®
 - ⊕ FS heavy-duty fitting
 - ⊕ EN 179 heavy-duty fitting
- For bearings, see page 52 ff.

Recessed lever handles

Flush ring handle

- Aluminium
- Stainless steel
- Bronze

42 4203 | 42 4204 ■

42 4203 00010 (square 8 mm)
42 4203 00014 (square spindle 8 mm)

42 4204 00010 (square 8 mm)
42 4204 00014 (square spindle 8 mm)

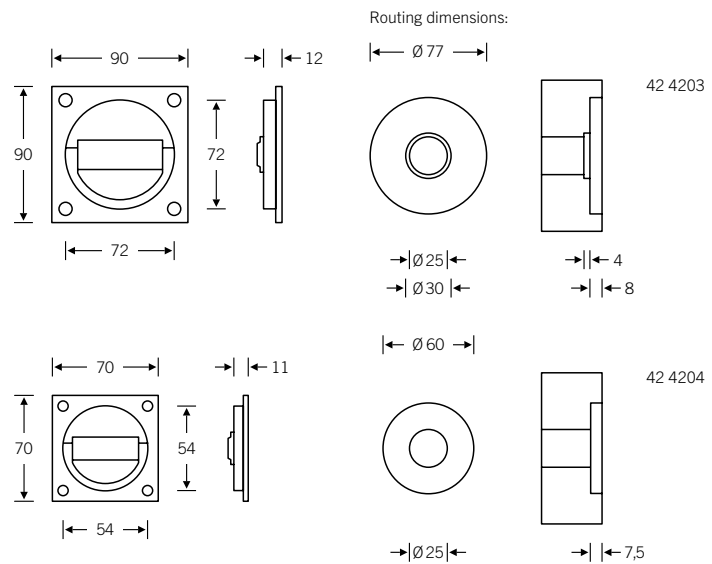

Please specify door thickness or spindle projection when ordering.

Drill hole for countersunk screws 3.5 mm

Recessed lever handles

Flush ring handle

- Aluminium
- Stainless steel
- Bronze

42 4205 ■

42 4205 00012 (square 8 mm)
42 4205 00018 (square spindle 8 mm)

Centres for PC 72 mm

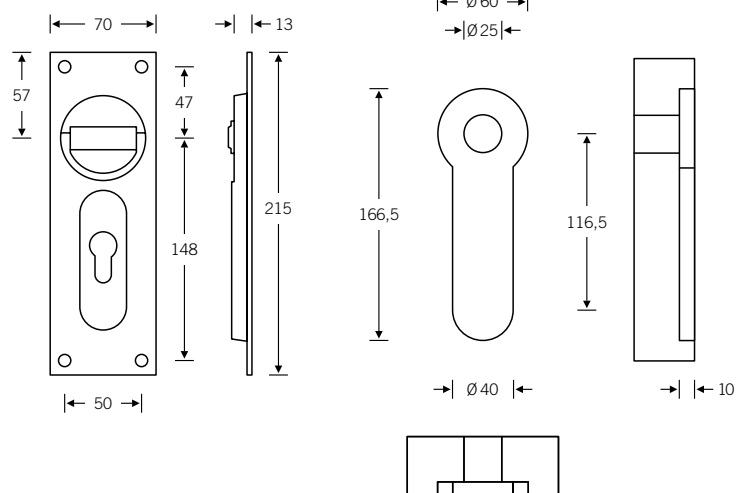

7b

Please specify door thickness or spindle projection when ordering.

Drill hole for countersunk screws 3.5 mm



- 588 Fittings for emergency exit and panic doors
- 592 Crossbar fittings for panic doors
- 604 Lever handles for emergency exit doors
- 609 Technical information

Fittings for emergency exit and panic doors

Added value at a glance

Always there to grab in case of emergency: FSB crossbar fittings provide a means of unlocking and opening doors through a pushing motion.

Escape-route doors must be able to be opened easily and fully from the inside within one second using a single movement with a defined level of force. These requirements are defined and described for all EU countries in the EN 179 and EN 1125

standards. EN 179 specifies the use and requirements for emergency exit devices with handles and push pads. FSB offers the most extensive range of compliant fittings in the industry. EN 1125 prescribes the use of panic exit devices wherever high levels of public traffic are to be expected and where panic may arise due to unfamiliarity with the surroundings. The fitting package for panic doors comprises a fastening element (lock), a lock receiver

(strike plate) and crossbar fitting. FSB crossbar fitting 77 7980 meets the highest standards of fitness for purpose and reliability. Nevertheless, FSB can only make recommendations on the use of fittings on escape and emergency exit routes. The project planner or local building inspection authorities are responsible for ensuring that the appropriate fittings are used.

Crossbar fittings for panic doors

FSB crossbar fittings 77 7980 and 77 7981 meet the requirements of EN 1125.

For single and double-leaf panic doors

Reset mechanism with positive mechanism spring brings the fitting back to its original position after use

The door can be opened by pressing on any part of the crossbar.

A stop device absorbs the forces exerted (e.g. for durability and resistance against abuse)

FSB also offers the tried-and-tested crossbar fitting 77 7970 for doors that do not have to conform to EN 1125. These fittings do not have a stop device and can be set to the operating angle of the lock.

The technically and functionally harmonised concept of combined lock and fitting has been adapted, tested and classified with lock systems from various well-known manufacturers

The force exerted is transmitted to the lock follower by a bevel gear acting directly through the square spindle

Crossbar fittings tested for door weights of up to 200 kg

Construction Products Regulation (CPR):
The declarations of performance used
by FSB to document compliance of the
EN 179 or EN 1125 fittings with the appli-
cable EU regulations.

Lever handles for emergency exit doors

Lever handles for flush and narrow-stile
doors meet EN 179 requirements

Rose and backplate sets available for flush
doors

Type B positive mechanism for flush doors,
type A positive mechanism for narrow-stile
doors

Optimal connection of base and cover rose
prevents the rose from wobbling

Narrow-stile door handles available in-line
and cranked

Round or angular roses

Most comprehensive range in the industry:
approx. 30 different door handle models
for flush doors and approx. 50 models for
narrow-stile doors

Continuity of design to match the product
collection

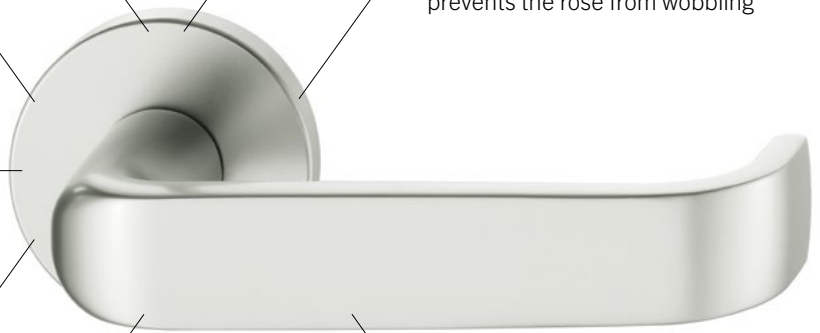

7c

Fittings for emergency exit and panic doors

Crossbar fitting for panic doors conforming to EN 1125

- Aluminium
- Stainless steel
- Bronze

77 7980 ■ ■

The bevel gear and square spindle work together to convert pressure exerted on the crossbar into rotary motion acting on the lock follower. A fixed stop device is fitted as a means of absorbing the requisite test forces. A spring ensures that the crossbar fitting returns to its original position once it has been operated.

The FSB 77 7980 crossbar fitting is suitable for locks by BMH, Fuhr, GEZE, SSF, Wilka and Winkhaus, and for different operating angles.

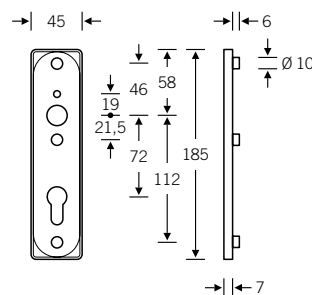
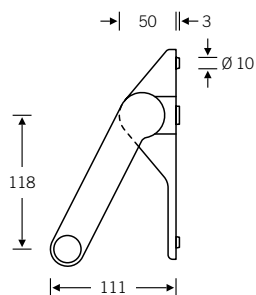
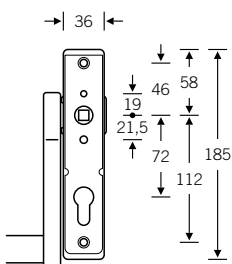
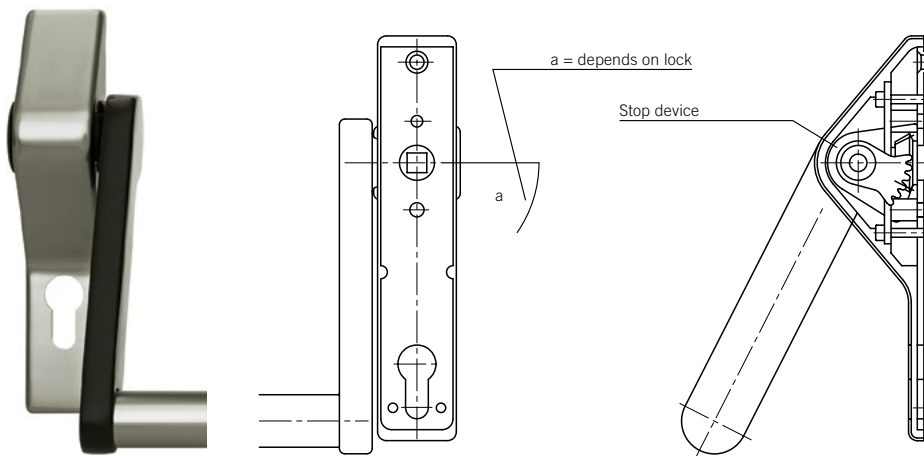

Size and mating dimensions for crossbar fittings PC 72 mm

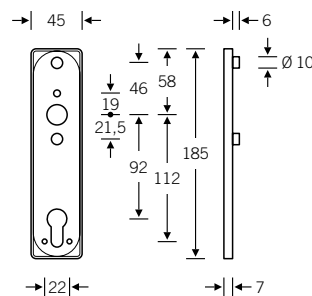
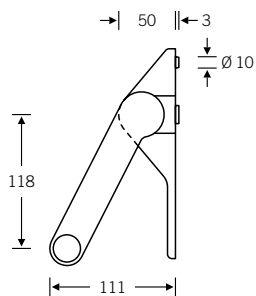
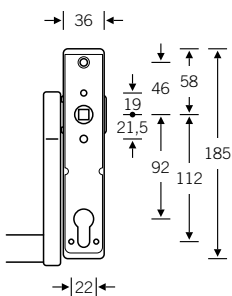

Size and mating dimensions for crossbar fittings PC 92 mm

Fittings for emergency exit and panic doors

Crossbar fitting for panic doors conforming to EN 1125

■ Aluminium
■ Stainless steel
■ Bronze

77 7980 ■ ■

Crossbar fitting for active leaf in fire safety variant, designed for flush doors

Centres for PC 72 mm

Suitable for locks:

BMH, $\alpha = 30^\circ$
 77 7980 01110 (RH fitting)
 77 7980 02110 (LH fitting)

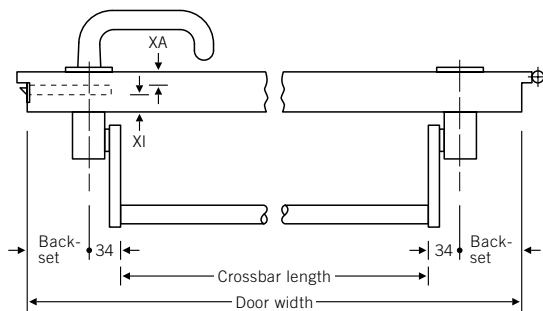
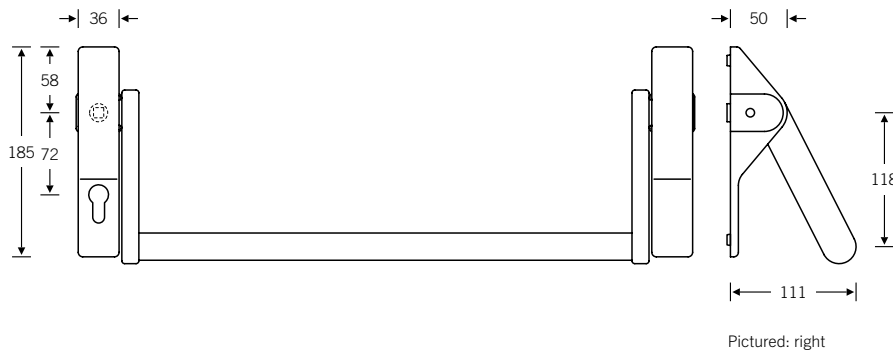

Determining bar length:

Door width
 – 2 × backset
 – 68 mm
 = Crossbar length
 (tested to max. 1,150 mm)

Order details required:

Material/finish
 Door thickness
 Door width
 Backset
 Dimension XI
 Dimension XA
 Handing
 (see figure on page 594)

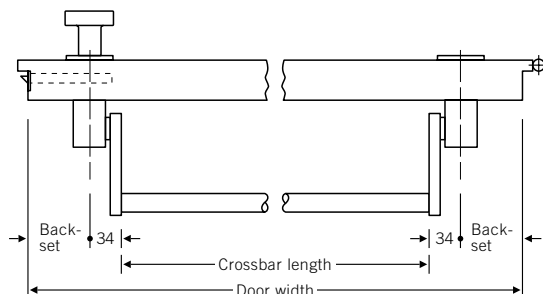

Order details required:

Material/finish
 Door thickness
 Door width
 Backset
 Handing
 (see figure on page 594)

Locks not included in scope of delivery
 For reverse-face fittings, see page 603

7c

Fittings for emergency exit and panic doors

Crossbar fitting for panic doors conforming to EN 1125

- Aluminium
- Stainless steel
- Bronze

77 7980

Crossbar fitting for inactive leaf in fire safety variant, designed for flush doors

Suitable for locks:

BMH, $\alpha = 45^\circ$
 77 7980 03400 (RH fitting)
 77 7980 04400 (LH fitting)

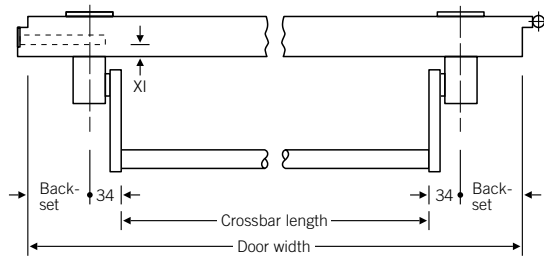
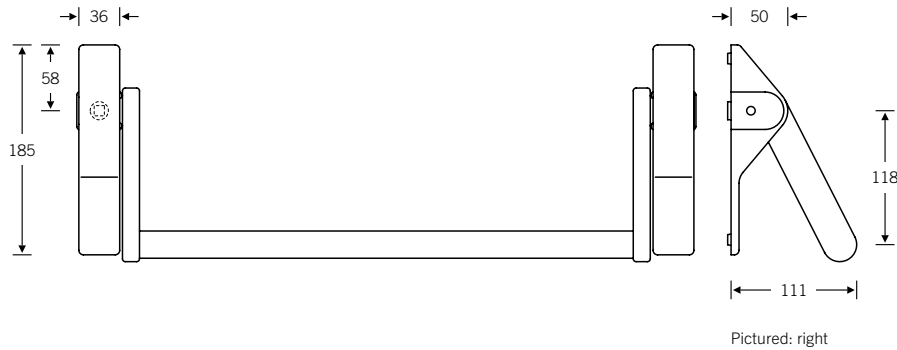

Determining bar length:

Door width
 – 2 × backset
 – 68 mm
 = Crossbar length
 (tested to max. 1,150 mm)

Order details required:

Material/finish
 Door thickness
 Door width
 Backset
 Dimension XI
 Handing
 (see below)

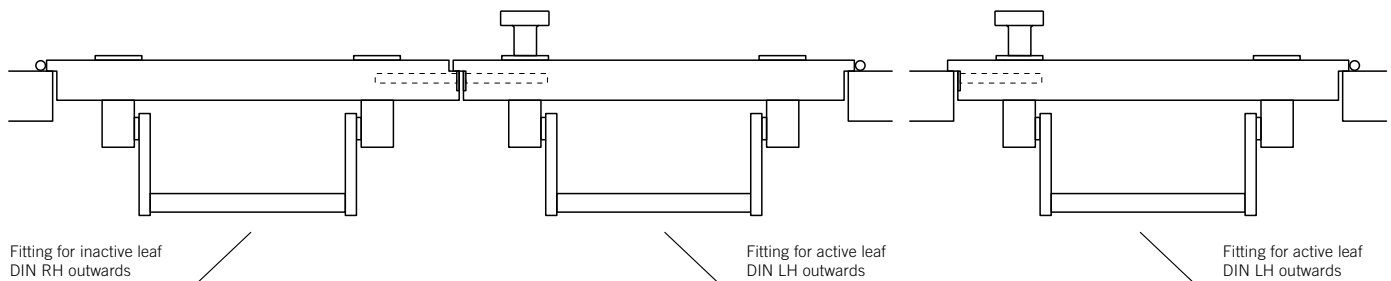

Locks not included in scope of delivery
 For reverse-face fittings, see page 603

Fittings for emergency exit and panic doors

Crossbar fitting for panic doors conforming to EN 1125

- Aluminium
- Stainless steel
- Bronze

77 7980

Crossbar fitting for active leaf in fire safety variant, designed for narrow-stile doors

Centres for PC 92 mm

Suitable for locks:

SSF (Series 02 APE/APB/APD) + Wilka + Fuhr Multisafe 833 and 834P, $a = 30^\circ$
 77 7980 01112 (RH fitting)
 77 7980 02112 (LH fitting)

Winkhaus, type STV AP3, $a = 45^\circ$
 77 7980 01412 (RH fitting)
 77 7980 02412 (LH fitting)

Winkhaus, type AP, $a = 47^\circ$
 77 7980 01512 (RH fitting)
 77 7980 02512 (LH fitting)

GEZE IQ Lock + Fuhr Multisafe 870 and 881, $a = 40^\circ$
 77 7980 01312 RH
 77 7980 02312 LH

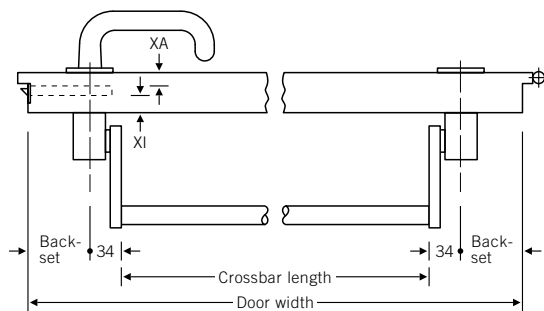
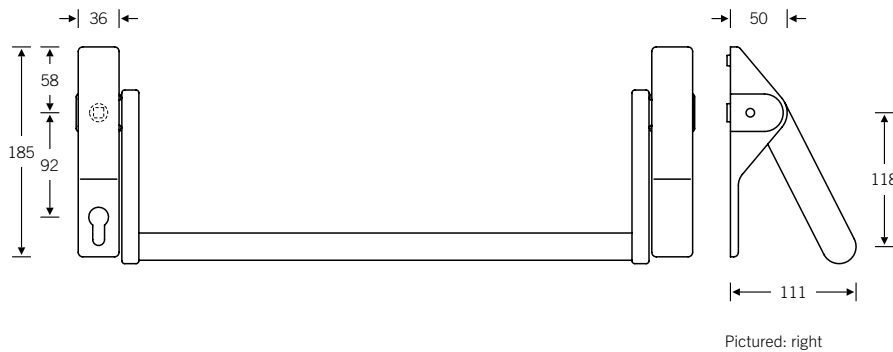

Determining bar length:

Door width
 – 2 × backset
 – 68 mm

= Crossbar length
 (tested to max. 1,150 mm)

Order details required:

Material/finish
 Door thickness
 Door width
 Backset
 Dimension XI
 Dimension XA
 Handing
 (see figure on page 596)

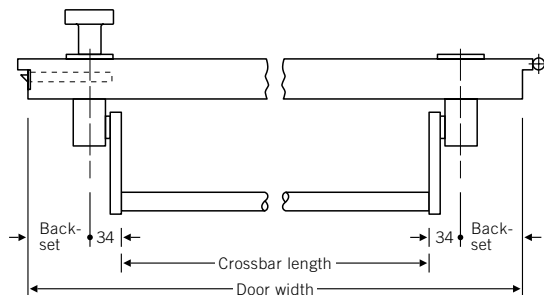

Order details required:

Material/finish
 Door thickness
 Door width
 Backset
 Handing
 (see figure on page 596)

Locks not included in scope of delivery
 For reverse-face fittings, see page 603

7c

Fittings for emergency exit and panic doors

Crossbar fitting for panic doors conforming to EN 1125

- Aluminium
- Stainless steel
- Bronze

77 7980

Crossbar fitting for inactive leaf in fire safety variant, designed for narrow-stile doors

Suitable for locks:

GEZE + Wilka, Fuhr Multisafe 833, 834P,
a = 40°
77 7980 03301 (RH fitting)
77 7980 04301 (LH fitting)

Winkhaus STV AP3, a = 45°
77 7980 03401 (RH fitting)
77 7980 04401 (LH fitting)

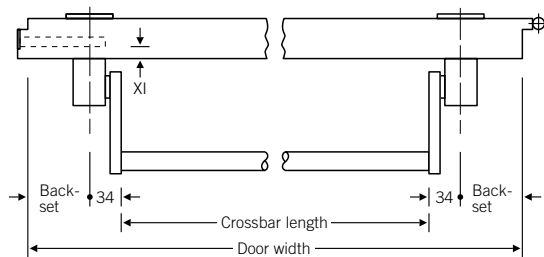
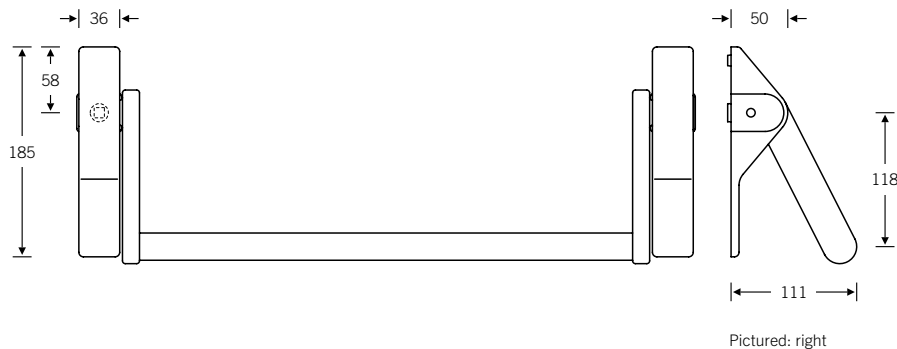

Determining bar length:

Door width
– 2 × backset
– 68 mm
= Crossbar length
(tested to max. 1,150 mm)

Order details required:

Material/finish
Door thickness
Door width
Backset
Dimension XI
Handing
(see below)

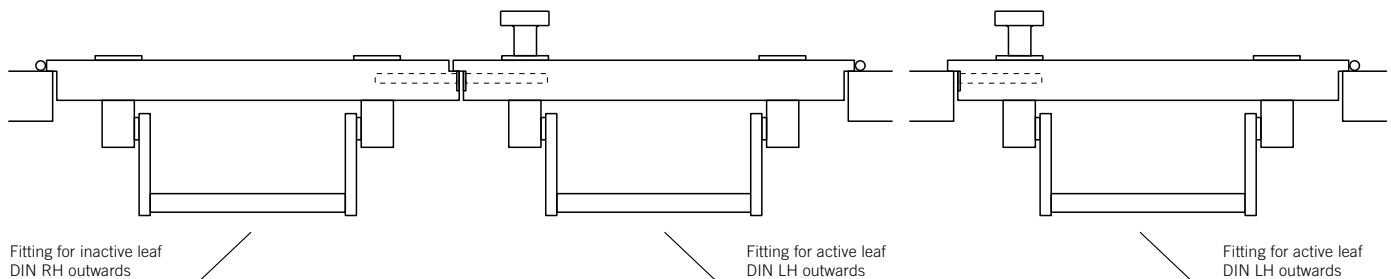

Locks not included in scope of delivery
For reverse-face fittings, see page 603

Fittings for emergency exit and panic doors

Crossbar fitting for panic doors conforming to EN 1125

- Aluminium
- Stainless steel
- Bronze

77 7981 ■ ■

The bevel gear and square spindle work together to convert pressure exerted on the crossbar into rotary motion acting on the lock follower. A fixed stop device is fitted as a means of absorbing the requisite test forces. A spring ensures that the crossbar fitting returns to its original position once it has been operated.

The FSB 77 7981 crossbar fitting is suitable for SSF locks and an operating angle of 30°.

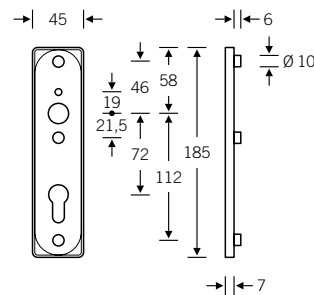
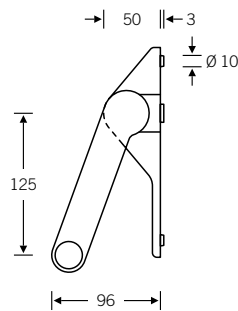
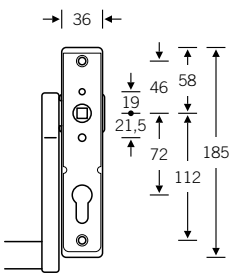
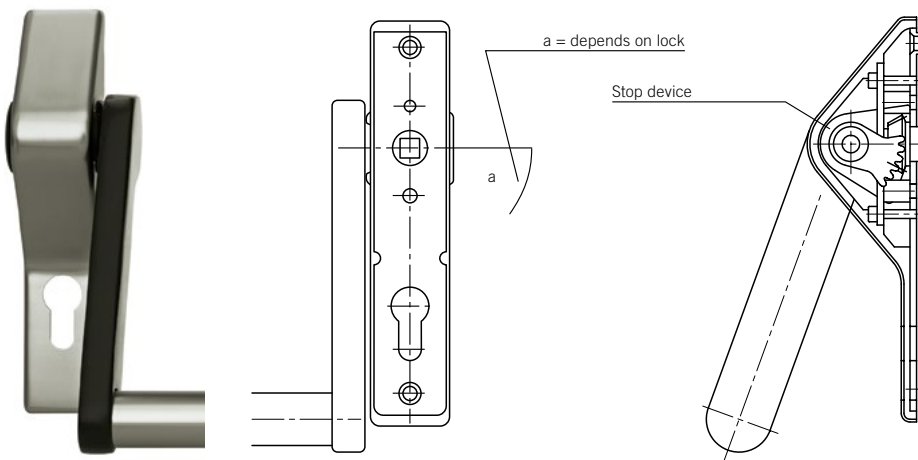

Size and mating dimensions for crossbar fittings PC 72 mm

7c

Fittings for emergency exit and panic doors

Crossbar fitting for panic doors conforming to EN 1125

- Aluminium
- Stainless steel
- Bronze

77 7981

Crossbar fitting
for active leaf in fire safety variant,
designed for flush doors

Centres for PC 72 mm

Suitable for locks:

SSF, $a = 30^\circ$
77 7981 01110 RH
77 7981 02110 LH

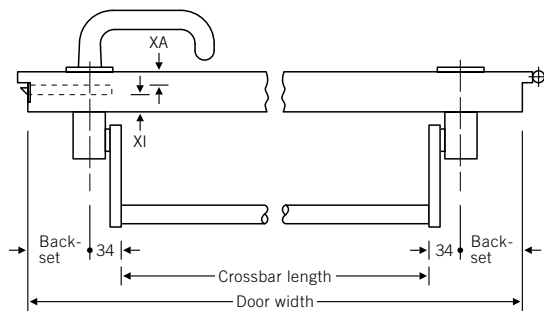
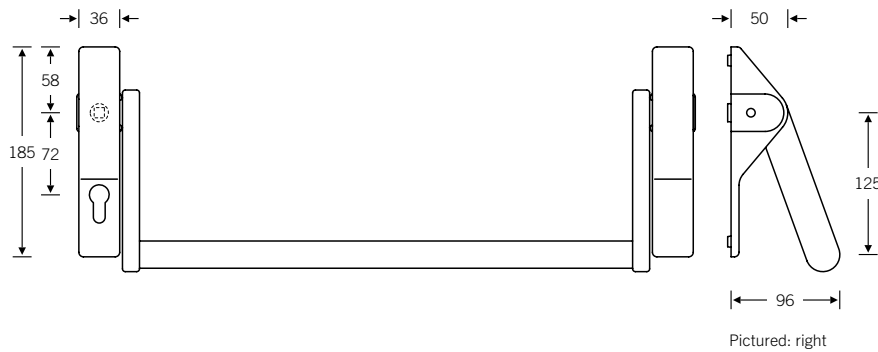

Determining bar length:

Door width
– 2 × backset
– 68 mm
= Crossbar length
(tested to max. 1,150 mm)

Order details required:

Material/finish
Door thickness
Door width
Backset
Dimension XI
Dimension XA
Handing
(see figure on page 599)

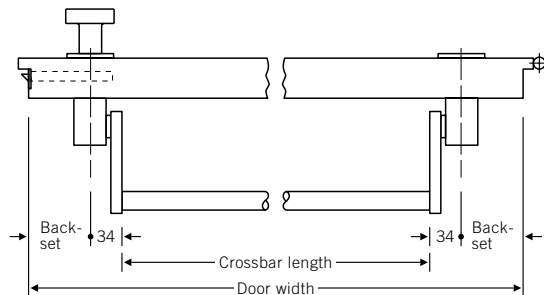

Order details required:

Material/finish
Door thickness
Door width
Backset
Handing
(see figure on page 599)

Locks not included in scope of delivery
For reverse-face fittings, see page 603

Fittings for emergency exit and panic doors

Crossbar fitting for panic doors conforming to EN 1125

- Aluminium
- Stainless steel
- Bronze

77 7981 ■ ■

Crossbar fitting for inactive leaf in fire safety variant, designed for flush doors

Suitable for locks:

SSF, $\alpha = 30^\circ$
 77 7981 03100 RH
 77 7981 04100 LH

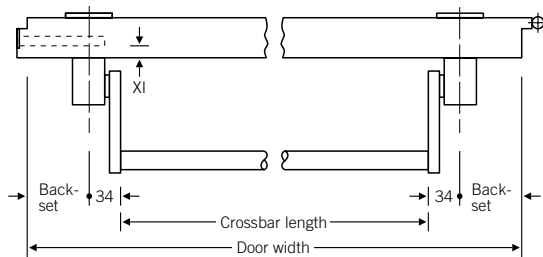
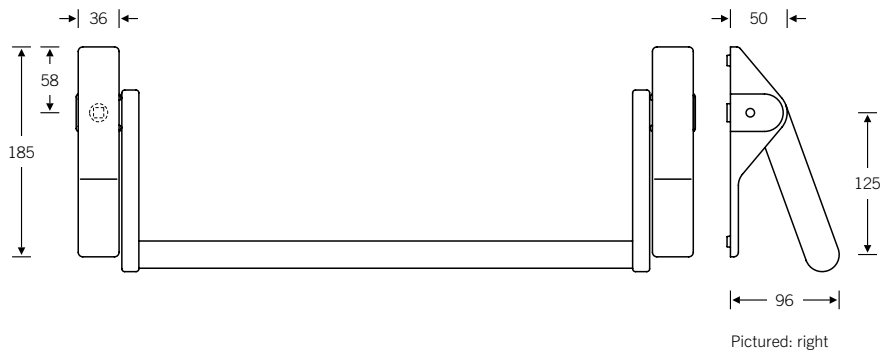

Determining bar length:

Door width
 - 2 × backset
 - 68 mm
 = Crossbar length
 (tested to max. 1,150 mm)

Order details required:

Material/finish
 Door thickness
 Door width
 Backset
 Dimension XI
 Handing
 (see below)

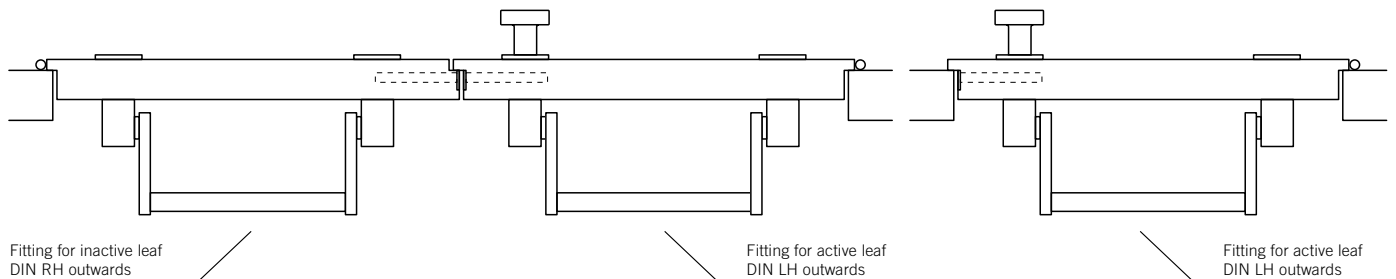

Locks not included in scope of delivery
 For reverse-face fittings, see page 603

7c

Fittings for emergency exit and panic doors

Crossbar fitting for panic doors

- Aluminium
- Stainless steel
- Bronze

77 7970

The bevel gear and square spindle work together to convert pressure exerted on the crossbar into rotary motion acting on the lock follower. A stop device that can be adjusted during installation based on the operating angle is fitted to protect the lock follower. A strong spring ensures that the crossbar fitting returns to its original position once it has been operated.

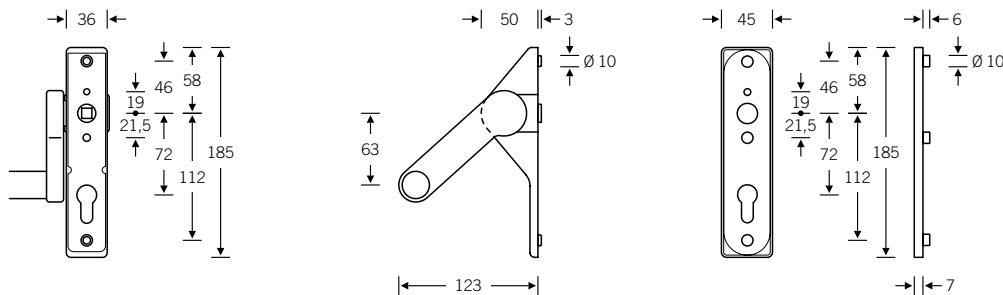
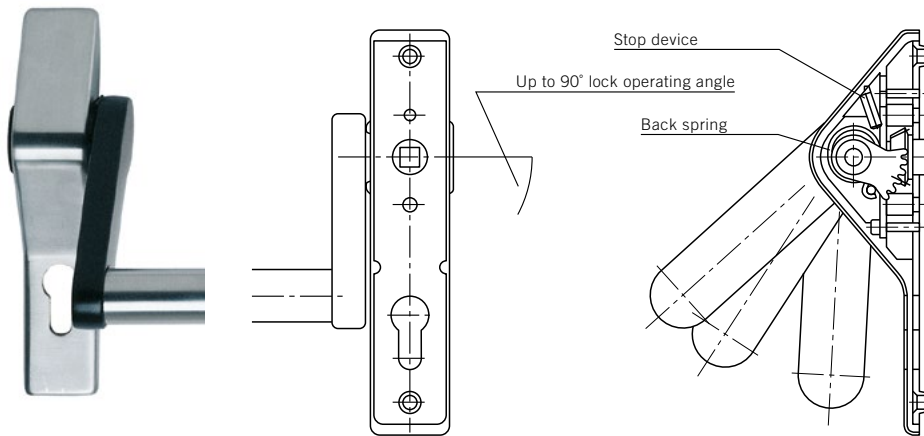

Size and mating dimensions for crossbar fittings PC 72 mm

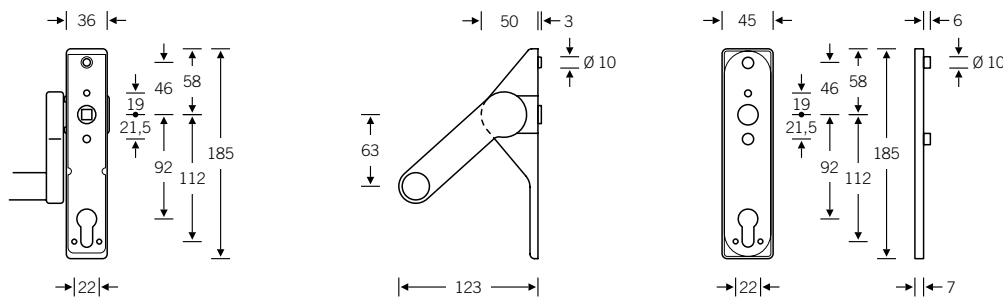

Size and mating dimensions for crossbar fittings PC 92 mm

Locks not included in scope of delivery
For reverse-face fittings, see page 603

Fittings for emergency exit and panic doors

Crossbar fitting for panic doors

- Aluminium
- Stainless steel
- Bronze

77 7970

Crossbar fitting
for active leaf

Designed for flush doors

77 7970 00110 (PC 72 mm)
77 7970 00112 (PC 92 mm)

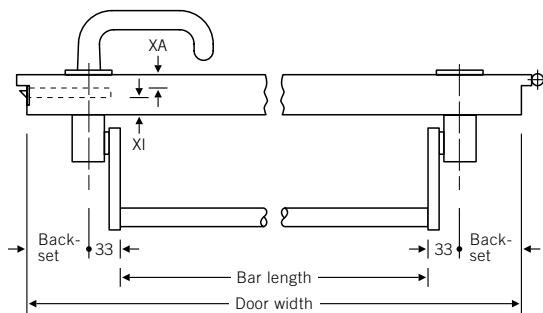
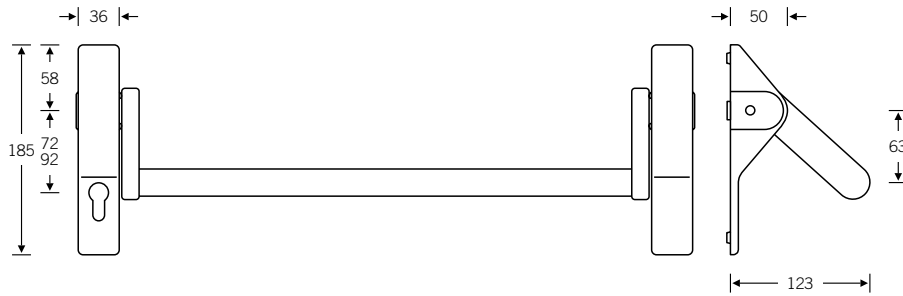

Determining bar length:

Door width
– 2 × backset
– 66 mm

= Crossbar length

Order details required:

Material/finish
Door thickness
Door width
Backset
Dimension XI
Dimension XA

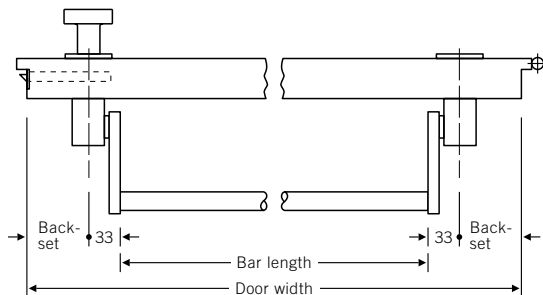

Order details required:

Material/finish
Door thickness
Door width
Backset

Locks not included in scope of delivery
For reverse-face fittings, see page 603

7c

Fittings for emergency exit and panic doors

Crossbar fitting for panic doors

- Aluminium
- Stainless steel
- Bronze

77 7970

Crossbar fitting
for inactive leaf

Designed for flush doors

77 7970 00200*
77 7970 00201**

Fixing points:

* as for PC 72 mm
** as for PC 92 mm

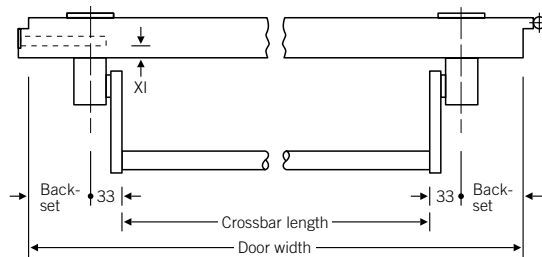
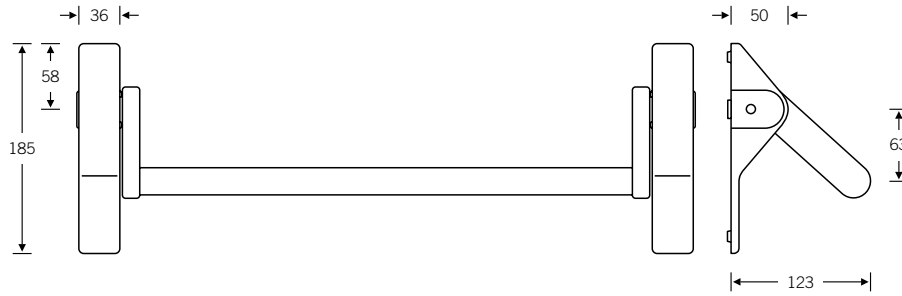

Determining bar length:

Door width
– 2 × backset
– 66 mm
= Crossbar length

Order details required:

Material/finish
Door thickness
Door width
Backset
Dimension XI

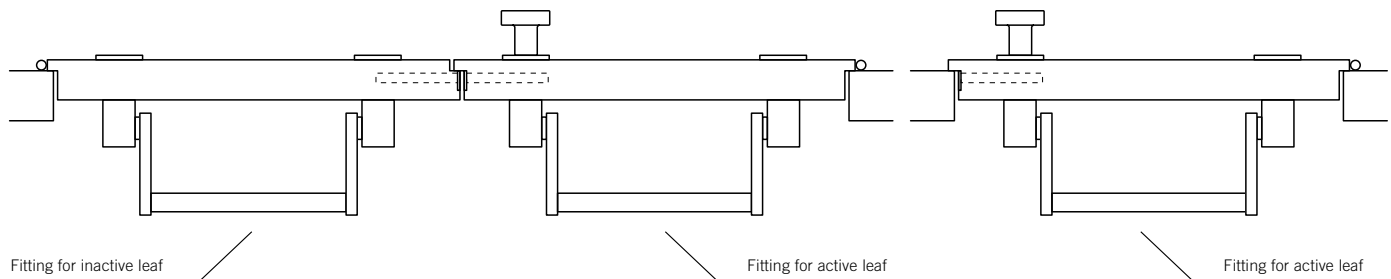

Locks not included in scope of delivery
For reverse-face fittings, see page 603

Fittings for emergency exit and panic doors

Reverse-face fittings for panic doors

- Aluminium
- Stainless steel
- Bronze

For reverse-face fittings, FSB supplies the FSB 1146 lever handle or 08 0829 knob as standard. Other lever handle and knob models are not possible.

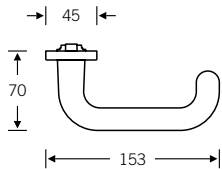

77 7971

77 7971 00010 (PC 72)
77 7971 00012 (PC 92)

Reverse lever handle backplate with concealed fixing in fire safety variant

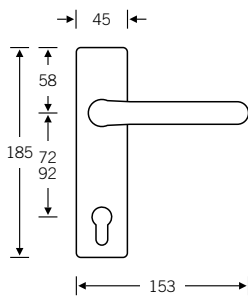

77 7972

77 7972 00110 (PC 72)
77 7972 00112 (PC 92)

Reverse knob backplate with fixed knob and concealed fixing in fire safety variant

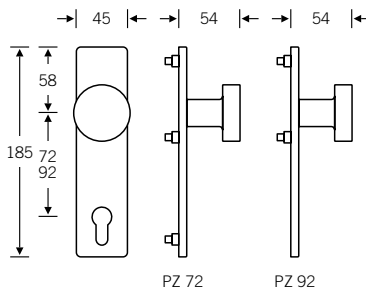

77 7973

77 7973 00000*
77 7973 00001**

Blank reverse backplate with concealed fixing in fire safety variant

Fixing points:
* as for PC 72 mm
** as for PC 92 mm

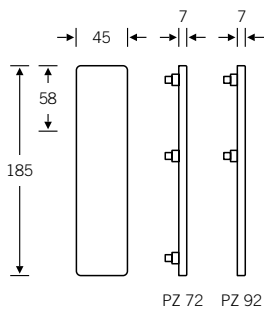

PC 72 suitable for locks from SSF and BMH

PC 92 suitable for locks from GEZE, Fuhr, SSF (series APE, APB, APD), Wilka and Winkhaus

7c

Fittings for emergency exit and panic doors

Lever handles for emergency exit doors conforming to EN 179

The following FSB fire-safety fitting systems plus the lever handle models listed in the overview fall within the scope of EN 179 and have been jointly tested and certified with the lock and strike plate series approved for use in combination with them:

- Lever/lever, lever/knob and inactive-leaf sets, each in variant as FSB
 - rose set
 - short backplate set
 - long backplate set
 - broad backplate set
- Lever/lever sets for narrow-stile doors and security fitting sets

Lever handles

for flush doors

For further information, see page 64 ff.

79 1002 ■
Page 80 ff.



79 1016 ■ ■ ■
Page 108 ff.



79 1031 ■ ■
Page 124 ff.



79 1043 ■ ■ ■
Page 178 ff.



79 1045 ■ ■ ■*
Page 130 ff.



79 1053 ■ ■ ■*
Page 118 ff.



79 1070 ■ ■ ■*
Page 144 ff.



79 1074 ■ ■ ■
Page 246 ff.



79 1088 ■ ■ ■
Page 160 ff.



79 1094 ■ ■ ■
Page 166 ff.



79 1098 ■ ■ ■
Page 160 ff.



79 1119 ■ ■ ■*
Page 196 ff.



79 1134 ■ ■ ■
Page 90 ff.



79 1146 ■ ■ *
Page 212 ff.



79 1159 ■ ■
Page 224 ff.



79 1160 ■ ■ *
Page 230 ff.



79 1164 ■ ■ ■
Page 236 ff.



79 1177 ■ ■
Page 184 ff.



79 1178 ■ ■
Page 190 ff.



79 1232 ■ *
Page 256 ff.



79 1243 ■ ■ ■
Page 266 ff.



79 1245 ■ ■ *
Page 272 ff.



79 1247 ■
Page 278 ff.



79 1255 ■
Page 288 ff.



79 1268 ■ ■ ■ *
Page 294 ff.



79 1272 ■ ■
Page 300 ff.



79 1278 ■
Page 252 ff.



79 1286 ■ *
Page 306 ff.



* 2 mm edge radii to prevent injury in accordance with DGUV requirements

7c

Fittings for emergency exit and panic doors

Lever handles for emergency exit doors conforming to EN 179

Lever handles

for narrow-stile doors

06 1002 ■
09 1002 ■
Pages 82, 84



06 1016 ■ ■ ■
09 1016 ■ ■ ■
Pages 110, 112



06 1031 ■ ■
09 1031 ■ ■
Pages 126, 128



06 1043 ■ ■
09 1043 ■ ■ ■
Pages 180, 182



06 1045 ■ ■ ■
09 1045 ■ ■ ■
Pages 132, 134



06 1053 ■ ■ ■
09 1053 ■ ■ ■
Pages 120, 122



06 1070 ■ ■
09 1070 ■ ■
Pages 146, 148



06 0644 ■ ■
09 1074 ■ ■
Pages 248, 250



06 1088 ■ ■
09 1088 ■ ■
Pages 162, 164



06 1094 ■ ■
09 1094 ■ ■
Pages 168, 170



06 1098 ■
09 1098 ■
Pages 162, 164



06 1119 ■ ■
09 1119 ■ ■
Pages 198, 200



06 1134 ■ ■ ■
 09 1134 ■ ■ ■
 Pages 92, 94



06 1146 ■ ■
 09 1146 ■ ■
 Pages 214, 216



06 1159 ■ ■
 09 1159 ■ ■
 Pages 226, 228



06 1160 ■ ■
 09 1160 ■ ■
 Pages 238, 240



06 1164 ■ ■ ■
 09 1164 ■ ■ ■
 Pages 238, 240



06 1177 ■ ■
 09 1177 ■ ■
 Pages 186, 188



06 1178 ■ ■
 09 1178 ■ ■
 Pages 192, 194



06 1232 ■
 09 1232 ■
 Pages 258, 260



06 1243 ■ ■ ■
 09 1243 ■ ■ ■
 Pages 268, 270



06 1245 ■ ■
 09 1245 ■ ■
 Pages 274, 276



06 1247 ■
 09 1247 ■
 Pages 280, 282



06 1255 ■
 09 1255 ■
 Pages 290, 292



06 1268 ■ ■ ■
 09 1268 ■ ■ ■
 Pages 296, 298



06 1272 ■ ■
 Pages 302, 304



06 1286 ■
 09 1286 ■
 Pages 308, 310



609 **Technical information**
Fittings for emergency exit
and panic doors

Technical information

EN 1125 for panic exit devices

EN 1125 – Panic exit devices operated by a horizontal bar, for use on escape routes. Requirements and test methods

This European standard defines the requirements for the manufacture, fitness for purpose and testing of panic exit devices.

Typical designs consist of a crossbar, lock and strike plate. The FSB range includes a combination of crossbar fittings and mortice locks. This combination must be tested and certified as one exit device unit according to the standard. Accepted panic exit devices are given the CE conformity marking. They meet the state of the art and are considered regulated construction products falling within the scope of harmonised standards or as regulated building products included in Germany's Building Rules List B, Part 1.

The fitting system's CE marking ensures that only tested and compliant fittings may be installed. The FSB crossbar fitting is only one part of the panic exit device system. This fitting has been adapted, tested and classified with lock systems from various well-known manufacturers.

Technical requirements

According to the design requirements, a panic exit device must be constructed so that it opens the door immediately in the direction of escape if any part of the crossbar on the inside is pressed. The forces required to operate the panic exit device must be rated in such a way that children or people with disabilities are able to push the crossbar. The following criteria must be verified by an independent test body:

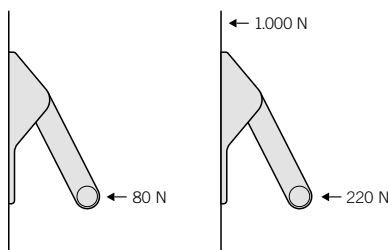

The test forces to open the door are measured on an unloaded (80 N) and pressure-loaded (220 N) door.

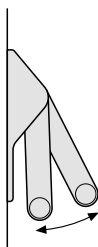

The durability is tested across 10,000 or 20,000 cycles for the inactive leaf and 100,000 or 200,000 cycles for the active leaf.

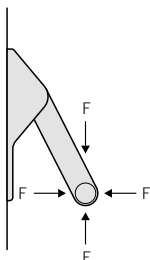

As resistance against abuse, the panic exit device must be able to withstand a load of 1,000 N in four directions.

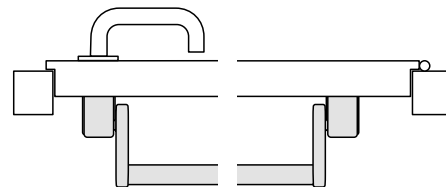

Panic exit devices must be designed so that the length of the crossbar matches the effective width of the door opening as far as possible but no less than 60 per cent.

FSB crossbar fittings are tested for door weights of up to 200 kg.

Technical information

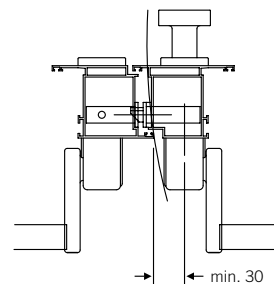

To prevent the 77 7970 or 77 7980 crossbar fitting from striking the door's own frame when the door is opened, it is necessary to maintain a distance between the frame and the centre of the fitting of at least 30 mm. Please bear this in mind when deciding on the door's stile and general configuration.

Technical information

EN 179 for emergency exit devices

EN 179 – Emergency exit devices

Emergency exit devices consist of a lock and fitting. They ensure in dangerous situations that the emergency exit door can be released and opened in a single movement, regardless of whether the door is locked or is only closed by the latch bolt. The standard governs the requirements and the test criteria to which the fittings and locks are subject.

These combinations of fittings as defined in EN 179 must be inspected jointly as regulated construction products, certified by a recognised certification body and given an EU or CE conformity marking. They meet the state of the art and are considered regulated construction products falling within the scope of harmonised standards or as regulated building products included in Germany's Building Rules List B, Part 1. FSB has joined forces with lock manufacturers to have combinations of fittings and locks tested and certified.

Technical requirements

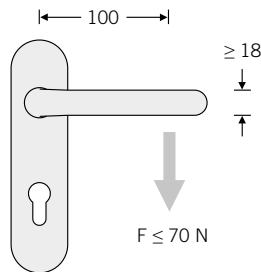

An emergency exit device must allow the door to be opened from the inside within one second with just one hand movement. The force required to operate the device must not exceed 70 N.

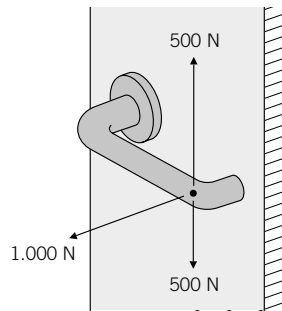

In order to test resistance against abuse, the fitting must be able to withstand a force of 1,000 N exerted vertically to the door leaf and a force of 500 N each exerted parallel to the door leaf.

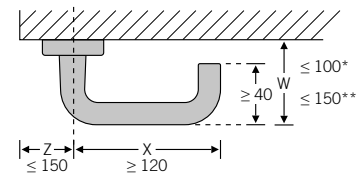

* Grade 2, normal projection
** Grade 1, extra projection

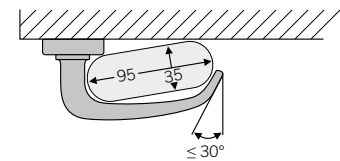

The lever handle must not have any corners or edges that could cause injury. Edge radius at least 0.5 mm. The free end of the handle must be designed so that it points toward the face of the door.

Durability is tested across 200,000 cycles. Suitability for a door weight of max. 200 kg (grade 6) is certified. FSB fittings conforming to EN 179 are also fire-safety compatible in accordance with DIN 18273.



612 XXL door handles

XXL door handles

Added value at a glance

As early as the 1980s, we were collaborating with the experts of the Fraunhofer Institute on the development of lever handles were optimised for use in the health and care sector and provided a convenient and secure grip in equal measure. Now with FSB 1287, we are going a step further: in hospitals and nursing homes, staff literally have their hands full.

FSB 1287 makes their work easier, when they are holding a tray, for example, and need to open a door at the same time: they simply place their forearm in the door handle, behind the bent grip section, and press down with their wrist or elbow. It's both convenient and hygienic at once.

Hands-free door opener: conveniently open doors with your forearm. Your hands are free for other things – and stay clean.

Equipped with FSB AGL® bearing: with 8, 8.5 or 9 mm square spindle

Retrofitting? No problem: all XXL door handles can be retrofitted at any time, taking technical circumstances into account.

Premium stainless steel alloy: corrosion-resistant and hard-wearing against dents and scratches, as well as withstanding cleaning agents and disinfectants commonly used in hospitals

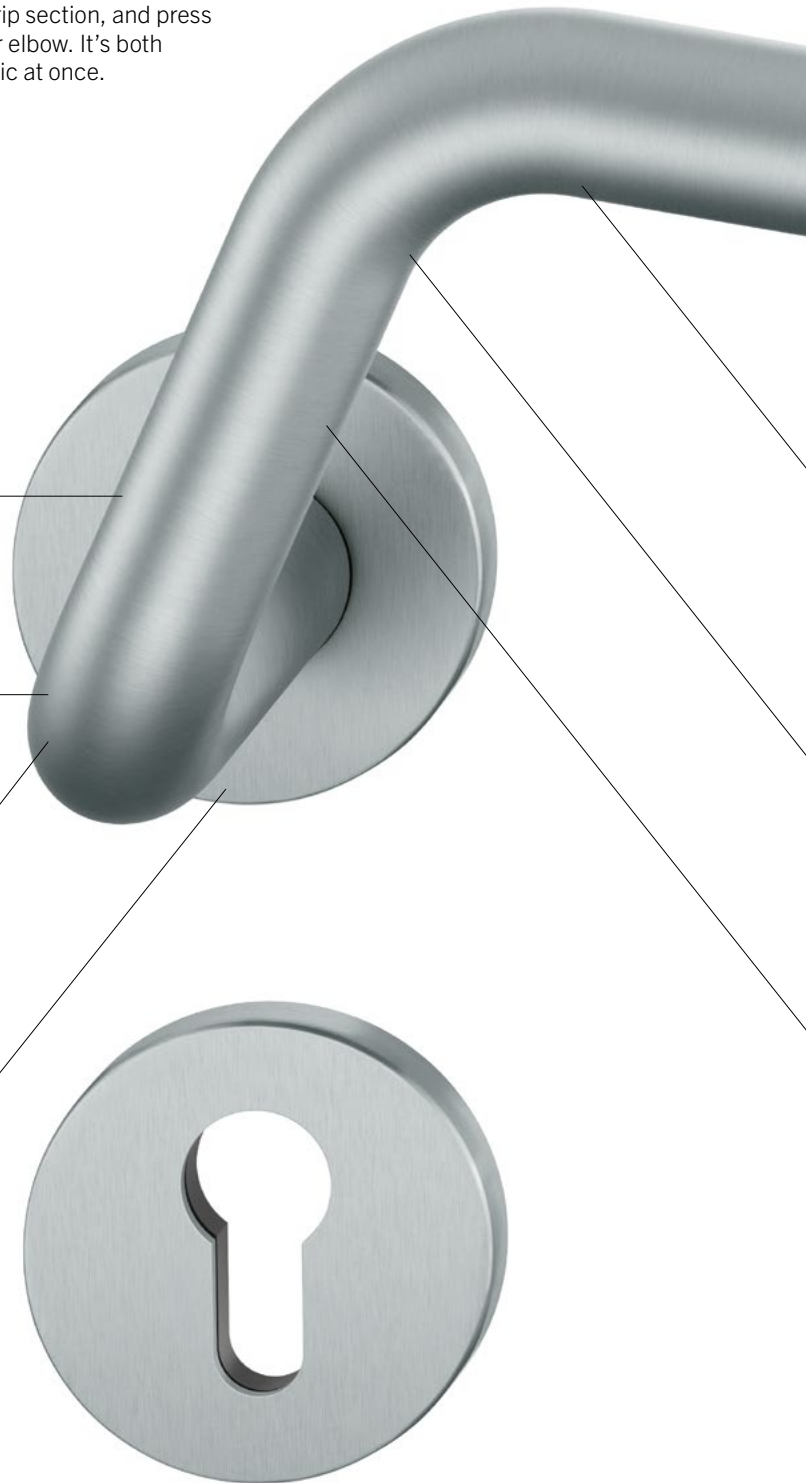



Ideal for high-traffic doors: for example, for use in hospitals, nursing homes, schools and nursery schools, and other public buildings

Measurements chosen based on the human body: the return-to-door of the FSB 1287 is positioned at an ergonomically optimal height of 111 cm.

Convenient operation from either side

Antibacterial finish: FSB 1287 is delivered with the FSB anti-infection coating (AIC) as standard; this finish is optionally available for all other models as well.

Suitable for heavy-duty applications: for standard, escape-route and fire doors pursuant to EN 179

7d

XXL door handles

Overview

■ Aluminium
■ Stainless steel
■ Bronze

1090 ■
Page 618



1117 ■
Page 618



1118 ■
Page 619



1119 ■ ■ ■
Page 619



1155 ■
Page 620



1287 ■
Page 621



97 7099 ■
Page 622



14 4240 ■ ■
14 4241 ■ ■
Page 623



XXL door handles

FSB 1090 | FSB 1117

- Aluminium
- Stainless steel
- Bronze

1090



Rose variant

79 1090 613 (R) | 79 1090 614 (L)
(turnably fixed with 9 mm square spindle)

Design matches FSB 1070 handle collection

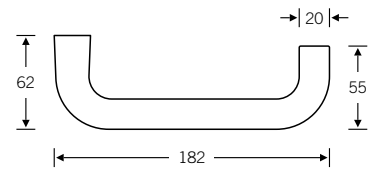

1117



Rose variant

79 1117 613 (R) | 79 1117 614 (L)
(turnably fixed with 9 mm square spindle)

Design matches FSB 1023 handle collection

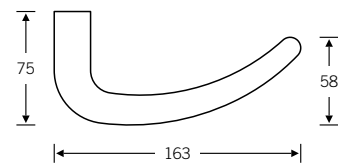

EN 179 model

FSB ASL®
FSB AGL®
FS heavy-duty fitting
EN 179 heavy-duty fitting
For bearings, see page 52 ff.

XXL door handles

FSB 1118 | FSB 1119

■ Aluminium
■ Stainless steel
■ Bronze

1118 ■



Rose variant

- 🔑 72 1118 613 (R) | 72 1118 614 (L)
 (turnably fixed with 8 mm square spindle)
- 🔑 79 1118 613 (R) | 79 1118 614 (L)
 (turnably fixed with 9 mm square spindle)
- 🔑 79 1118 713 (R) | 79 1118 714 (L)
 (turnably fixed with 8.5 mm square spindle)

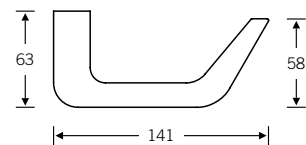

1119 ■ ■ ■



Rose variant

- 🔑 12 1119 013
 (turnably fixed with 8 mm square spindle)
- 🔑 72 1119 613 (R) | 72 1119 614 (L)
 (turnably fixed with 8 mm square spindle)
- 🔑 79 1119 613 (R) | 79 1119 614 (L)
 (turnably fixed with 9 mm square spindle)

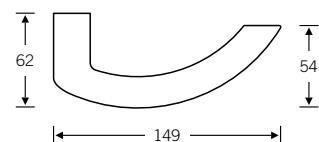

🔑 EN 179 model

🔑 FSB ASL®
🔑 FSB AGL®
🔑 FS heavy-duty fitting
🔑 EN 179 heavy-duty fitting
 For bearings, see page 52 ff.

7d

XXL door handles

FSB 1155

■ Aluminium
■ Stainless steel
■ Bronze

1155 ■

FSB 1155 incorporates insights gained by FSB in cooperation with the Fraunhofer Institute during scientific analyses conducted in the 1980s on the design of a lever handle for large-leaf doors in hospitals. In the KARMIN project, the multipurpose FSB 1155 lever handle was selected in 2017 for the first infection prevention patient room.

The KARMIN project (the name of which is an acronym composed of the German words for hospital, architecture, microbiome and infection) is an initiative of the German Federal Ministry of Education and Research. Affiliated partners include the Technical University of Braunschweig, the Charité – Universitätsmedizin Berlin and the Jena University Hospital, along with the Septomics Research Group and Röhl GmbH.

Rose variant

↻ 72 1155 613 (R) | 72 1155 614 (L)
(turnably fixed with 8 mm square spindle)

↻ 79 1155 613 (R) | 79 1155 614 (L)
(turnably fixed with 9 mm square spindle)

Main benefits at a glance:

- Triangular orientation matches the user's direction of movement
- Angular shape accommodates the sequence of movements when opening and closing the door
- Curve and cross-section match the hollow space created in the hand as it closes to grip
- Left/right alignment provides a firm hold if elbows are used to operate the door

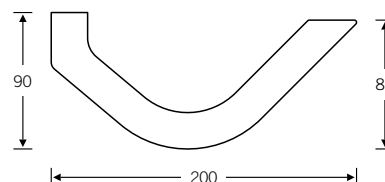

↻ EN 179 model

↻ FSB ASL®

↻ FSB AGL®

↻ FS heavy-duty fitting

↻ EN 179 heavy-duty fitting

For bearings, see page 52 ff.

XXL door handles

FSB 1287

■ Aluminium
■ Stainless steel
■ Bronze

1287 ■



Rose variant

- ↻ 72 1287 613 (R) | 72 1287 614 (L)
(turnably fixed with 8 mm square spindle)
- ↻ 72 1287 713 (R) | 72 1287 714 (L)
(turnably fixed with 8.5 mm square spindle)
- ↻ 79 1287 613 (R) | 79 1287 614 (L)
(turnably fixed with 9 mm square spindle)
- ↻ 79 1287 713 (R) | 79 1287 714 (L)
(turnably fixed with 8.5 mm square spindle)

Main benefits at a glance:

- Delivered with FSB anti-infection coating (AIC) as standard
- Hands-free door opener: operated with the forearm
- Return-to-door is positioned at the ergonomically optimal height of 111 cm
- Universal design

7d

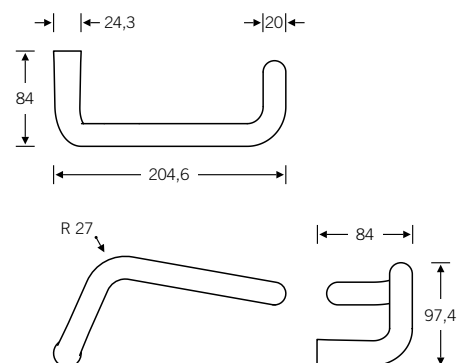

Design: Markus Michalski,
Michael Schmidt

↻ EN 179 model

↻ FSB ASL®
↻ FSB AGL®
↻ FS heavy-duty fitting
↻ EN 179 heavy-duty fitting
For bearings, see page 52 ff.

XXL door handles

FSB 97 7099

■ Aluminium
■ Stainless steel
■ Bronze

97 7099 ■

Rose variant

↻ 97 7099 00116
(turnably fixed with 10 mm square spindle)

Main benefits at a glance:

- 280 mm long
- For high-traffic doors, especially in hospitals and nursing homes
- 10 mm square spindle for perfect stability

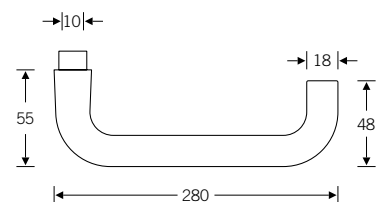

↻ EN 179 model

↻ FSB ASL®
↻ FSB AGL®
↻ FS heavy-duty fitting
↻ EN 179 heavy-duty fitting
For bearings, see page 52 ff.



XXL door handles

Barrier-free fitting





Aluminium
Stainless steel
Bronze



Illustrative example featuring FSB 1119

14 4240  

Standard variant:

-  14 4240 14...
(DIN RH, opening inwards, square spindle 8 mm)
-  14 4240 15...
(DIN LH, opening inwards, square spindle 8 mm)
-  14 4240 61...
(DIN RH, opening inwards, square spindle 9 mm)
-  14 4240 71...
(DIN LH, opening inwards, square spindle 9 mm)
FS approval under DIN 18273

Centres 72 mm (WC 78 mm)
concealed fixing on both sides, suitable for locks pursuant to DIN 18251, meets DIN 18040-1 (handle height 850 mm)

Routing work performed on existing fire and smoke control doors in preparation for installing barrier-free fittings renders the door's fire-safety status void. Please consult the door maker on whether there is fire-safety approval for installing barrier-free fittings on the door concerned or whether an exception can be made in this case.

The square spindle for the handle is connected to the upper square spindle serving to operate the lock follower by means of a rod. When the handle is operated, the rod turns the upper spindle in the lock follower, thus releasing the latch bolt.

M5 stainless steel screws are included in the scope of delivery depending on the door thickness.

Main benefits at a glance:

- Easy operation by wheelchair users
- Keys can be inserted more easily because the cylinder is located above the door handle
- Easy refit: renovation variant (width 55 mm) covers existing drill holes
- Rugged mechanism integrated, which allows the lever handle to be positioned beneath the cylinder



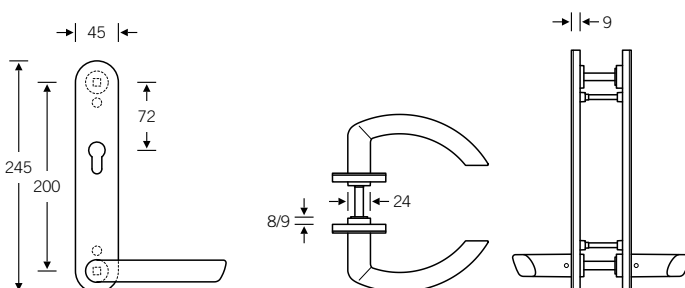

Standard variant 14 4240



Order details required:

- Door thickness
- DIN handing, opening inwards
- Square spindle 8 or 9 mm
- Centres of lock cylinder
- Door handle model

Other keyways (see page 387) and centres are available upon request.

-  FSB ASL®
 -  FSB AGL®
 -  FS heavy-duty fitting
 -  EN 179 heavy-duty fitting
- For bearings, see page 52 ff.



46

- 626 Fittings for entrance doors
- 702 Door pulls with Fingerscan
- 712 Security fittings

A coordinated range of fittings completes the calling card of every building: the entrance door. This range includes, among other things, flush-fitted security roses that can be combined with door pulls in an optimal way and represent a very exclusive form of door refinement. Security fittings guarantee maximum security as well as looking nice, on both commercial and residential entrance doors. (Pictured: FSB 66 6550 door pull)

Project: Family home, Gütersloh
Architectural firm: Heitmann Architekten





- 626 Fittings for entrance doors
- 634 Push/pull pad handles
- 638 Door pulls
- 683 Half-sets
- 686 Letter plates
- 689 Technical information

Fittings for entrance doors

Added value at a glance

Be it in the form of classic tubular pulls with round or oval cross-sections, or pared-down push/pull pad handles from the S-Flat series with angular or square cross-sections, FSB has the perfect design to hand for any door and taste. Besides 'analogue' pulls, we also offer an impressive solution for the digital operation of doors with the Fingerscan series. More information about FSB's biometric systems can be found starting on page 702.

Over 40 pull designs

Linear, symmetrical and asymmetrical shapes

Round, oval and angular grip cross-sections

Numerous door pulls also available in bespoke lengths

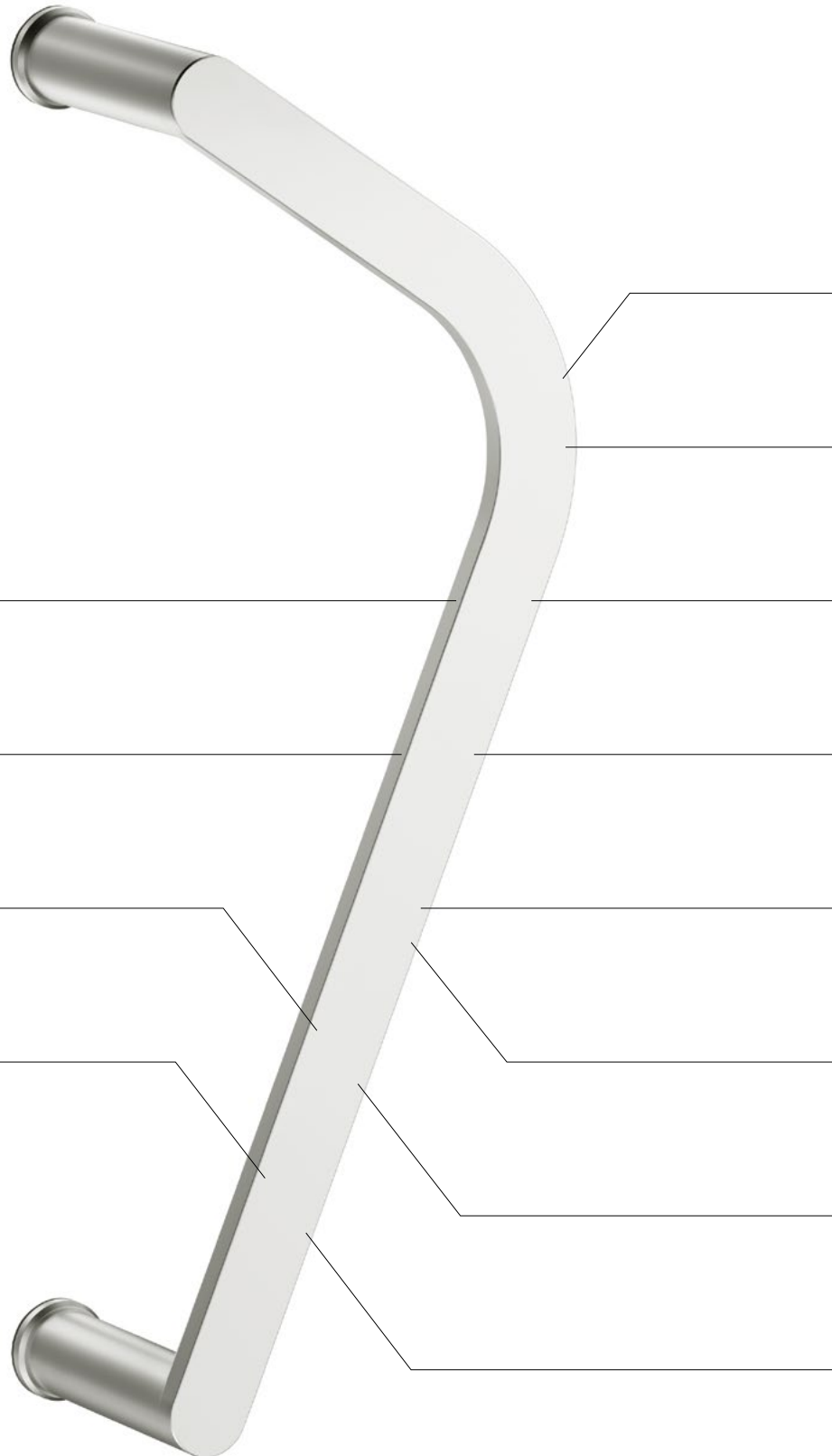

In addition to door pulls, FSB offers S-Flat push/pull pad handles with pleasantly soft Technogel padding on the back.

Quick and easy installation with just an Allen key

Door pull models also available with Fingerscan; see page 702 ff.

Fixing to all types of doors possible

Individual gripping devices and brackets can be configured with the ht kit.

Diverse materials and finishes

All pulls suitable for back-to-back and face fixing

Discreet, concealed fixing of door pulls

8a

Fittings for entrance doors

Overview

Push/pull pad handles

61 6108 ■
Page 634



61 6181 ■
Page 634



61 6184 ■
Page 635



61 6186 ■
Page 636



61 6187 | 61 6188 ■
Page 636



61 6254 ■
Page 635



66 6628 ■ ■
Page 637



66 6629 ■
Page 637



Door pulls

angular

66 6519 ■
Page 638



66 6520 ■
Page 638



66 6540 ■
Page 642



66 6548 ■
Page 640



66 6527 ■
Page 643



Door pulls

oval

66 6533 ■
Page 644



66 6535 ■ ■
Page 644



66 6536 ■ ■
Page 645



66 6537 ■
Page 645



66 6538 ■ ■
Page 646



66 6542 ■
Page 647



66 6612 ■
Page 648



66 6616 ■
Page 649



66 6635 ■
Page 650



66 6650 ■
Page 650



66 6652 ■
Page 651



66 6675 ■
Page 651



66 6524 ■ ■
Page 652



66 6735 | 66 6736 ■
Page 654



66 6737 | 66 6738 ■
Page 654



8a

Fittings for entrance doors

Overview

Door pulls

round

66 6506 
Page 657



66 6507 
Page 657



66 6514 
Page 658



66 6615 
Page 659



66 6526 
Page 660



66 6541 
Page 662



66 6546 
Page 663



66 6602 
Page 656



66 6623 
Page 672



66 6630 
Page 664



66 6642 
Page 666



66 6643 
Page 666



66 6653 
Page 668



66 6655 
Page 668



66 6662 
Page 669



66 6669 
Page 670



66 6674 
Page 671



66 6681 
Page 674



66 6683 
Page 673



Door pulls

round

66 6522 ■ ■
Page 676



66 6523 ■ ■
Page 676



66 6715 | 66 6716 ■
Page 678



66 6717 | 66 6718 ■
Page 678



Door pulls

half-round

66 6550 ■
Page 680



66 6551 ■
Page 681



66 6552 ■
Page 682



Half-sets

Lever handles ■ ■ ■
For more models, see
page 683 ff.



03 0418 002 ■ ■
Page 685



03 0418 003 ■ ■ ■
Page 685



Letter plates

38 3826 ■ ■
Page 686



38 3826 ■ ■
38 3829 ■
Page 687



Fittings for entrance doors

Push/pull pad handles

- Aluminium
- Stainless steel
- Bronze

61 6108

Aluminium bracket | stainless steel pad
M8 fixing

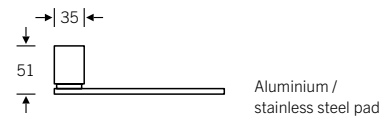
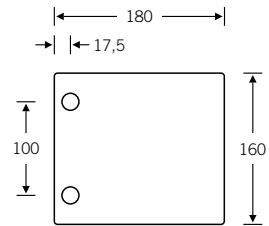

61 6181

61 6181 00062

Screw hole \varnothing 8.5 mm (base)
For fixing accessories, see page 769 ff.

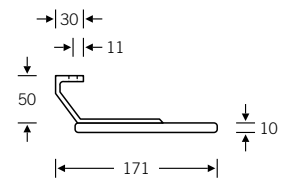
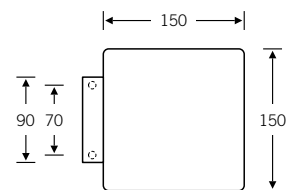

Fittings for entrance doors

Push/pull pad handles

- Aluminium
- Stainless steel
- Bronze

61 6184 ■

61 6184 00062

Black anodised aluminium pad
Screw hole \varnothing 8.5 mm (base)

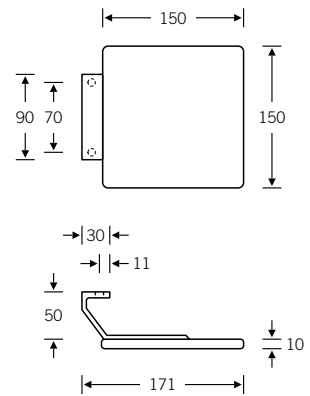

61 6254 ■

61 6254 00062

Screw hole \varnothing 8.5 mm (base)
For fixing accessories, see page 769 ff.

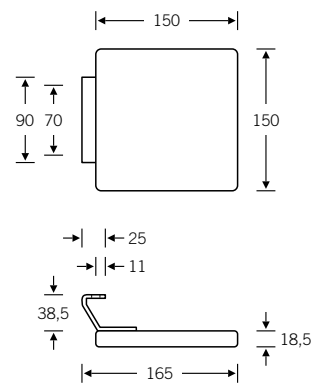

8a

Fittings for entrance doors

S-Flat series push/pull pad handles

- Aluminium
- Stainless steel
- Bronze

61 6186 ■

Design: Hartmut Weise

Silver-grey powder-coated brackets
M8 fixing

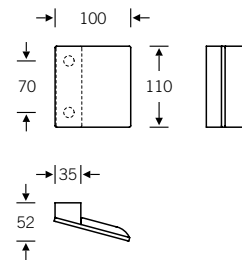

61 6187 | 61 6188 ■

Design: Hartmut Weise

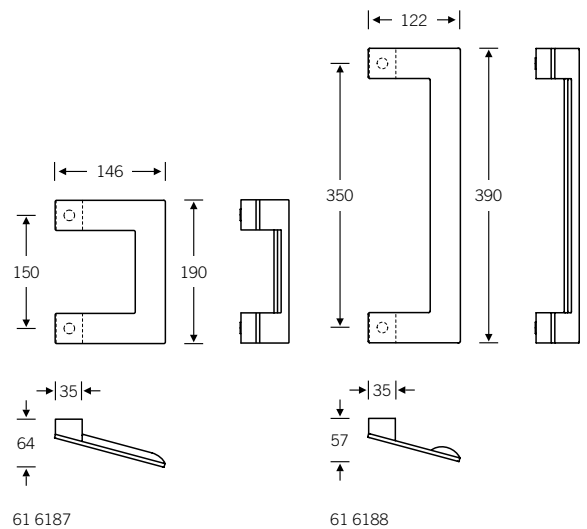

Angular, open
Silver-grey powder-coated brackets
M8 fixing



Fittings for entrance doors

Push/pull pad handles

- Aluminium
- Stainless steel
- Bronze

66 6628  



The combination of 66 6628 and 66 6629 is suitable for double-action swing doors

Installed using the fixing points of the base rose

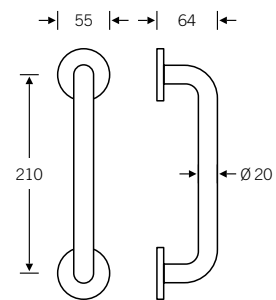

66 6629 



The combination of 66 6629 and 66 6628 is suitable for double-action swing doors

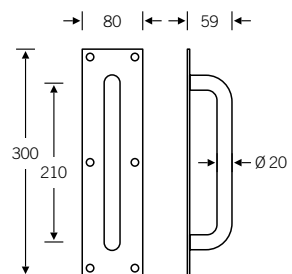

8a

Fittings for entrance doors

Angular door pulls

- Aluminium
- Stainless steel
- Bronze

66 6519 ■



Grip cross-section 25 × 25 mm
Standard length 500 mm (also in bespoke lengths; see order form on next page)
M8 fixing
Safety clearance S = 53 mm
(see page 690)

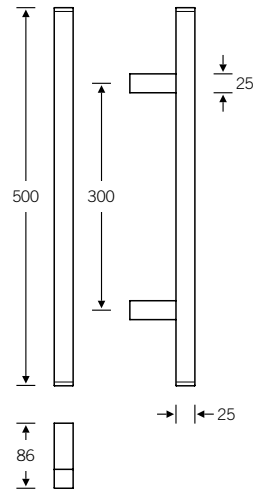

66 6520 ■

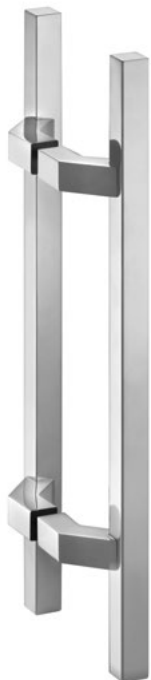

Grip cross-section 25 × 25 mm
Standard length 500 mm (also in bespoke lengths; see order form on next page)
M8 fixing
Safety clearance S = 46 mm
(see page 690)

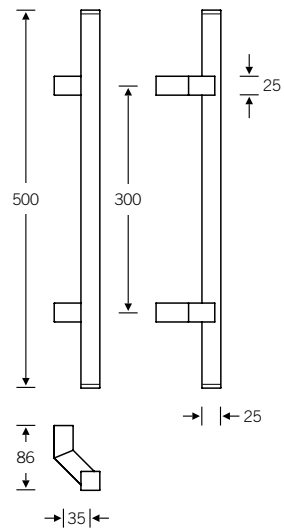

Fittings for entrance doors

Order form

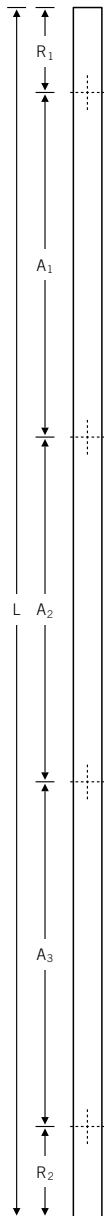
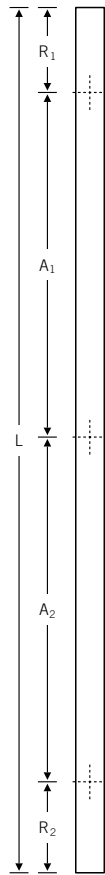

Please use a copy of this page when ordering door-pull series 66 6519 or 66 6520 of variable length:

First tick the box next to the product code for the variant desired. Enter details of quantities required and overall length in the table below.

Please also indicate bracket spacings and the edge spacing in mm. Bracket spacings should not exceed 1,200 mm for reasons of stability.

66 6519 099 (grip cross-section 25 mm)



66 6520 099 (grip cross-section 25 mm)



8a

| Qty | Length overall L | Bracket spacing | | | Edge spacing* | | Fixing type |
|-----|---------------------|-----------------|----------------|----------------|----------------|----------------|-------------|
| | | A ₁ | A ₂ | A ₃ | R ₁ | R ₂ | |
| | | | | | | | |
| | | | | | | | |
| | | | | | | | |

* min. 30 mm, max. 350 mm

Fittings for entrance doors

Angular door pull

- Aluminium
- Stainless steel
- Bronze

66 6548 ■

Matching FSB 1003
Grip cross-section 40 × 10 mm
M8 fixing
Safety clearance S = 55 mm
(see page 690)

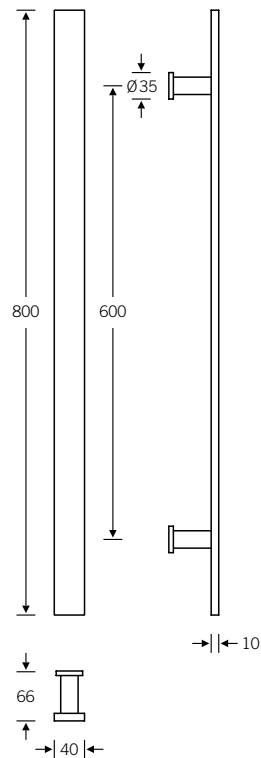

Fittings for entrance doors

Order form

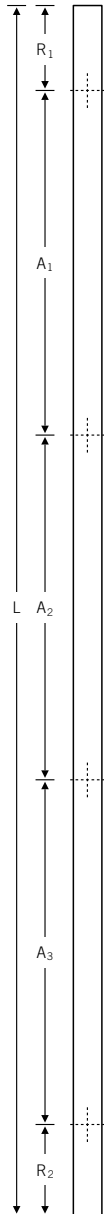
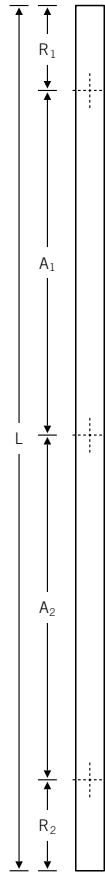
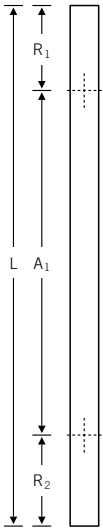

Please use a copy of this page when ordering door-pull series 66 6548 of variable length:

Enter details of quantities required and overall length in the table below. Please also indicate bracket spacings and the edge spacing in mm. Bracket spacings should not exceed 600 mm and the edge spacing should not exceed 250 mm for reasons of stability.

66 6548 (grip cross-section 40 × 10 mm)



8a

| Qty | Length overall L | Bracket spacing | | | Edge spacing* | | Fixing type |
|-----|---------------------|-----------------|----------------|----------------|----------------|----------------|-------------|
| | | A ₁ | A ₂ | A ₃ | R ₁ | R ₂ | |
| | | | | | | | |
| | | | | | | | |
| | | | | | | | |

* min. 30 mm, max. 250 mm

Fittings for entrance doors

Angular door pull

- Aluminium
- Stainless steel
- Bronze

66 6540 ■

Matching FSB 1035
Grip cross-section $\varnothing 15 \times 25$ mm
M8 fixing
Safety clearance $S = 45$ mm
(see page 690)

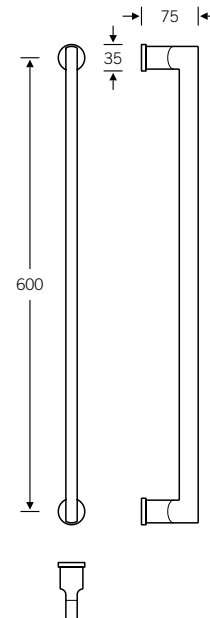

Fittings for entrance doors

Angular welded ht door pull

■ Aluminium
■ Stainless steel
■ Bronze

66 6527 ■



Angular grip cross-section
 Rectangular tube 35 × 35 × 3 mm
 Bracket centres (A) 350 mm to 2,100 mm

- Works-welded
- Made to order
- Desired **bracket combinations** (see below) are expressed by combining numbers, e.g. 66 6527 **4545**
- The bracket spacing (A) is measured from the centre of the screw hole of one bracket to the centre of the screw hole of the other bracket; the overall length of the door pull is determined by adding the dimensions 2 × 20 mm (drill hole centres including material thickness).

When using angular welded ht door pulls, structural requirements and conditions on site must be considered. These handles are no substitute for gymnastic bars and must not be used as safety barriers at hazardous building openings. If in doubt please consult the architect or structural engineer in charge. Fixing system details can be found on page 691 ff.

45 . . 46 . . right 56 . . left

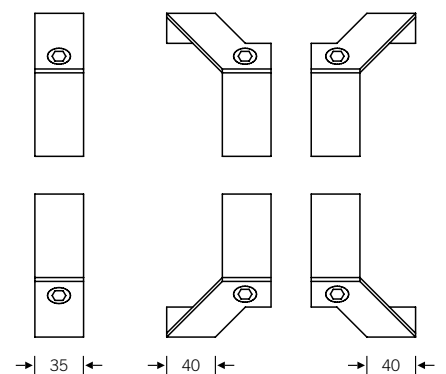

. . 45 . . 46 right . . 56 left

8a

Fittings for entrance doors

Oval door pulls



- Aluminium
- Stainless steel
- Bronze

66 6533 

Design: Hartmut Weise

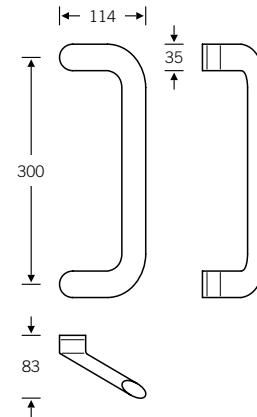
Grip cross-section $\varnothing 35 \times 17.5$ mm
M8 fixing



66 6535  

Design: Hartmut Weise

Grip cross-section $\varnothing 35 \times 17.5$ mm
M8 fixing

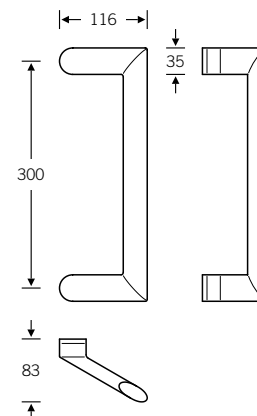

Fittings for entrance doors

Oval door pulls

- Aluminium
- Stainless steel
- Bronze

66 6536 

Design: Hartmut Weise

Grip cross-section $\varnothing 35 \times 17.5$ mm
M8 fixing

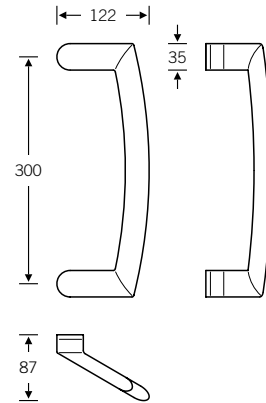

66 6537 

Design: Hartmut Weise

Grip cross-section $\varnothing 39 \times 20$ mm
M8 fixing

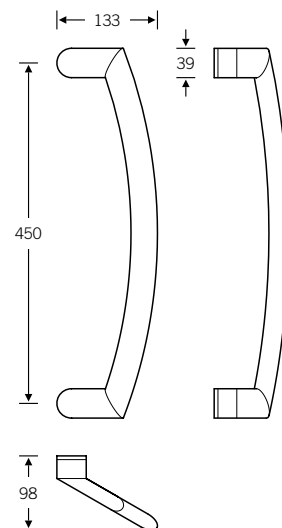

8a

Fittings for entrance doors

Oval door pull

- Aluminium
- Stainless steel
- Bronze

66 6538 

Design: Hartmut Weise

Grip cross-section $\varnothing 39 \times 20$ mm
M8 fixing

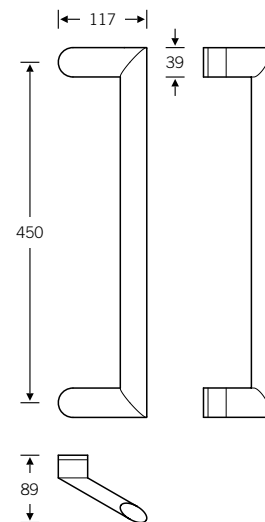

Fittings for entrance doors

Oval door pull

- Aluminium
- Stainless steel
- Bronze

66 6542 ■

| Product code | A | Ø | C | D | S |
|--------------|-----|---------|----|----|----|
| 66 6542 030 | 300 | 30 × 15 | 60 | 35 | 48 |
| 66 6542 060 | 600 | 40 × 28 | 75 | 45 | 55 |

Matching FSB 1107 and FSB 1108
M8 fixing
S = safety clearance (see page 690)

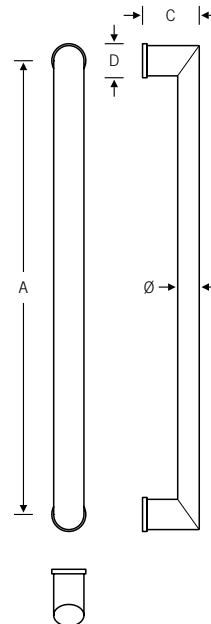

8a

Fittings for entrance doors

Oval door pulls

- Aluminium
- Stainless steel
- Bronze

66 6612 ■

M6 fixing
Safety clearance S = 48 mm
(see page 690)

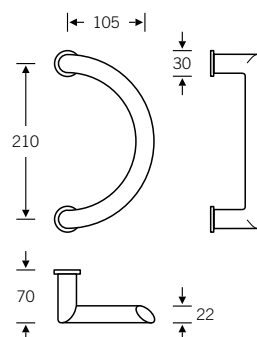

Fittings for entrance doors

Oval door pull

- Aluminium
- Stainless steel
- Bronze

66 6616 ■

| Product code | A | Ø | L |
|--------------|-----------|---------|------|
| 66 6616 035 | 350 | 40 × 28 | 550 |
| 66 6616 045 | 450 | 40 × 28 | 650 |
| 66 6616 099 | 451–2,100 | 40 × 28 | var. |

Grip cross-section Ø 40 × 28 mm
M8 fixing

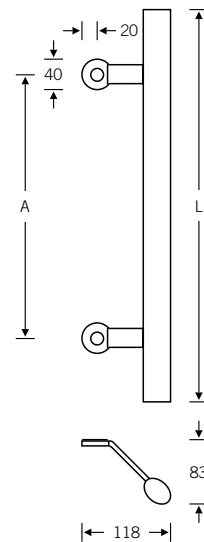

8a

FSB recommends a maximum bracket spacing of 1,200 mm.

Fittings for entrance doors

Oval door pulls

- Aluminium
- Stainless steel
- Bronze

66 6635

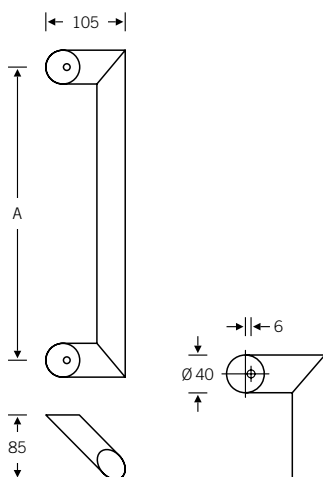

| Product code | A | Ø |
|--------------|-------------|---------|
| 66 6635 038 | 350 | 40 × 28 |
| 66 6635 045 | 450 | 40 × 28 |
| 66 6635 099 | 451 – 2,100 | 40 × 28 |

M8 fixing

FSB's oval series was inaugurated with door-pull model FSB 66 6635. Its easy-grip oval tube (Ø 40 × 28 mm) was to be ergonomically aligned in such a way that it could be safely and purposefully grasped. This objective was achieved by welding the handle and brackets together at an angle of 90° to form mitred joints.

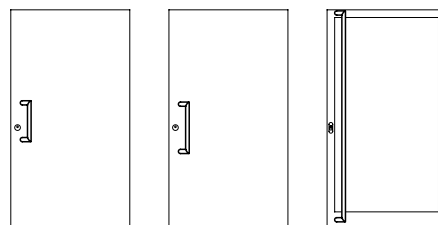

66 6650



| Product code | A | Ø |
|--------------|-------------|---------|
| 66 6650 038 | 350 | 36 × 22 |
| 66 6650 099 | 351 – 1,200 | 36 × 22 |

M8 fixing
Safety clearance S = 49 mm
(see page 690)

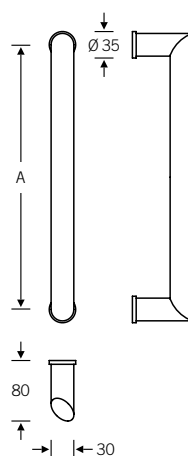

Fittings for entrance doors

Oval door pulls

■ Aluminium
■ Stainless steel
■ Bronze

66 6652 ■

Grip cross-section $\varnothing 36 \times 22$ mm
 M8 fixing
 Safety clearance $S = 53$ mm
 (see page 690)

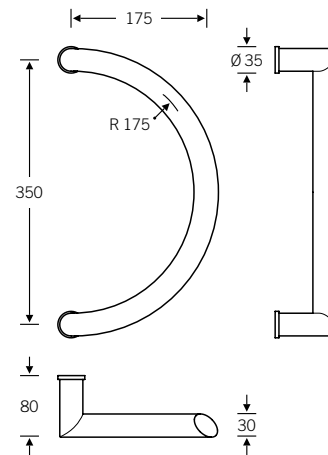

66 6675 ■

| Product code | A | \varnothing | R | B | L |
|--------------|-----|---------------|------|-----|-----|
| 66 6675 021 | 210 | 40 × 28 | 485 | 132 | 504 |
| 66 6675 035 | 350 | 40 × 28 | 1420 | 129 | 745 |



M8 fixing

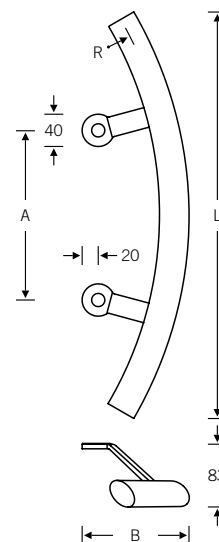

8a

Fittings for entrance doors

Oval welded ht door pull

- Aluminium
- Stainless steel
- Bronze





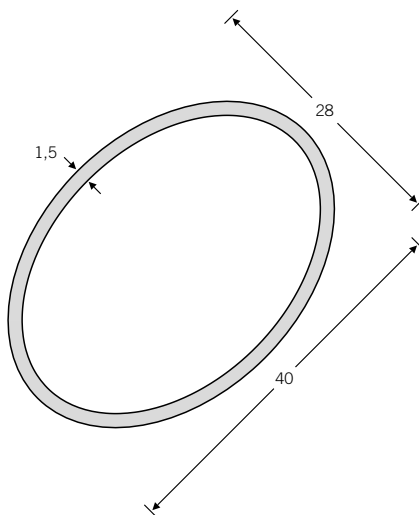



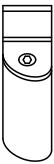

66 6524 ■ ■

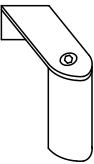
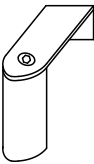
1,000 mm to 2,100 mm
Tube 28 × 40 × 1.5 mm

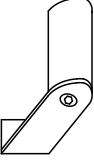
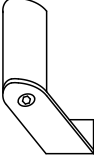

- Works-welded
- Made to order
- Desired **bracket combinations** (see below) are expressed by combining numbers, e.g. 66 6524 **4545**
- Bronze variant only available with bracket combinations 45/55 or 46/56
- The bracket spacing (A) is measured from the centre of the screw hole of one bracket to the centre of the screw hole of the other bracket; the tube length of the door pull is determined by adding or subtracting the differential dimensions (see following page) prior to welding the parts together at the plant.

Bracket combinations

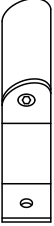
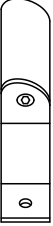
| | | | | | | | |
|-------------------------------------------------------------------------------------|-------------------------------------------------------------------------------------|-------------------------------------------------------------------------------------|-------------------------------------------------------------------------------------|---------------------------------------------------------------------------------------|---------------------------------------------------------------------------------------|---------------------------------------------------------------------------------------|---------------------------------------------------------------------------------------|
| 45 . . right | 55 . . left | 46 . . right | 56 . . left | 47 . . right | 57 . . left | 48 . . right | 58 . . left |
|  |  |  |  |  |  |  |  |
|  |  |  |  |  |  |  |  |
| . . 45 right | . . 55 left | . . 46 right | . . 56 left | . . 47 right | . . 57 left | . . 48 right | . . 58 left |

When using oval ht door pulls (for self-assembly or in the works-welded variant), structural requirements and conditions on site must be considered. These handles are no substitute for gymnastic bars and

must not be used as safety barriers at hazardous building openings. If in doubt please consult the architect or structural engineer in charge. Fixing system details can be found on page 691 ff.

Fittings for entrance doors

Oval ht kit

- Aluminium
- Stainless steel
- Bronze



66 6802 ■

Lengths up to 1,500 mm
 Tube 28 × 40 × 1.5 mm
 Stock length supplied 3,000 mm

- High degree of flexibility, such as on the construction site
- Handle systems, handrails, safety rails, etc. can be cut to size on site, configured and installed from FSB tubes and brackets
- We recommend works-welded variant FSB 66 6524 when bracket centres (A) measure 1,500 mm or more; see previous page.

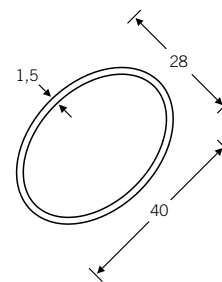

Cut-to-size dimensions and bracket combinations

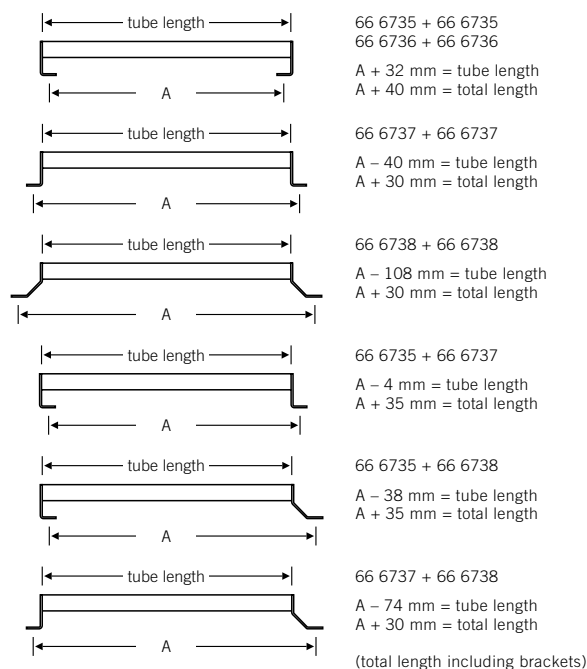

The tube length and bracket centres (A) have an important bearing on manufacturing, installation and ordering. The bracket spacing (A) is measured from the centre of the screw hole of one bracket to the centre of the screw hole of the other bracket. The tube length is calculated from the bracket centres (A) by adding or subtracting the differential dimensions provided here.

In the case of door pulls from the oval ht kit that are used on high-traffic doors, FSB recommends reinforcing them with the aid of the dedicated accessories we supply.

8a

When using oval ht door pulls (for self-assembly or in the works-welded variant), structural requirements and conditions on site must be considered. These handles are no substitute for gymnastic bars and

must not be used as safety barriers at hazardous building openings. If in doubt please consult the architect or structural engineer in charge. Fixing system details can be found on page 691 ff.

Fittings for entrance doors

Door-pull brackets from the oval ht kit

- Aluminium
- Stainless steel
- Bronze

66 6735 ■

66 6735 004 (R) | 66 6735 005 (L)

In-line bracket, joint angled 90° inwards, suitable for oval tube $\varnothing 40 \times 28 \times 1.5$ mm

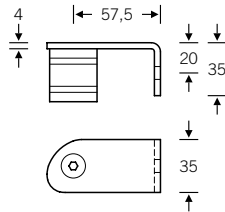

66 6736 ■

66 6736 014 (R) | 66 6736 015 (L)

Cranked 45° bracket, joint angled 90° inwards, suitable for oval tube $\varnothing 40 \times 28 \times 1.5$ mm

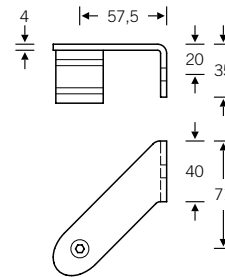

66 6737 ■

66 6737 004 (R) | 66 6737 005 (L)

In-line bracket, joint angled 90° outwards, suitable for oval tube $\varnothing 40 \times 28 \times 1.5$ mm

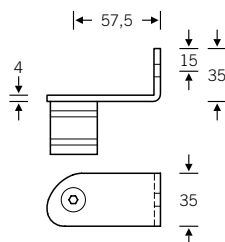

66 6738 ■

66 6738 004 (R) | 66 6738 005 (L)

Bracket for swing doors, suitable for oval tube $\varnothing 40 \times 28 \times 1.5$ mm

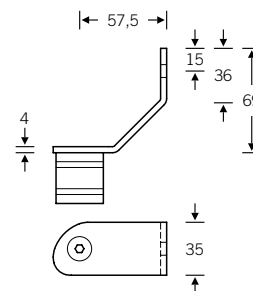

Screw hole $\varnothing 8.5$ mm
Safety clearance $S = 52$ mm
(see page 690)

All examples shown are RH models

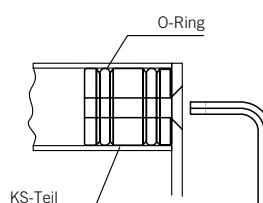

Once the tube has been cut to size (bracket centres A +/- differential dimension), the expansion plugs for the brackets selected are inserted into the two ends of the tube and activated by screwing them in at the top.

Fittings for entrance doors

Door-pull accessories from the oval ht kit

In the case of door pulls from the oval ht kit that are used on high-traffic doors or with bracket centres (A) measuring 1,500 – 2,100 mm, FSB recommends reinforcing them with the aid of the dedicated accessories presented here – or even better, opting for works-welded variant 66 6524 (see page 652).

Assembly instructions: cut the hollow steel bar to a length equal to that of the pull tube minus 100 mm. Slide spacer sleeves over the bar at intervals of 350 mm and secure. Insert the assembly into the pull tube and fit the hardware.

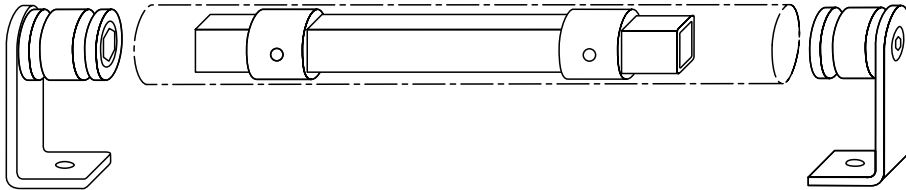

66 6801

Hot-dip galvanised hollow steel bar

66 6801 02020

20 × 20 × 2 mm
Stock length supplied 3,000 mm

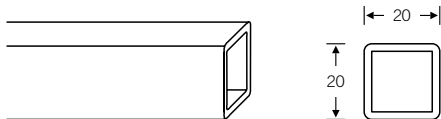

66 6739

Plastic

Spacer sleeve with securing screw

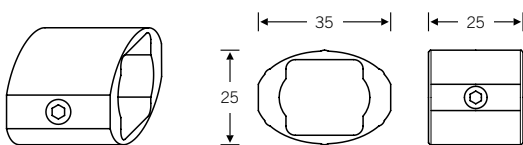

05 03..



05 0313 00880 (M8 × 80 mm)
Grub screw

05 0316 00840 (M8)
Headless wood screw

05 0320 00800 (M8)
Stainless steel domed nut

Fittings for entrance doors

Round door pull

■ Aluminium
■ Stainless steel
■ Bronze

66 6602 ■ ■ ■



| Product code | A | ∅ | R | C | D | S |
|--------------|-----------|----|----|-----|----|----|
| 66 6670 034 | 200 | 25 | 40 | 80 | 35 | 48 |
| 66 6670 037 | 300 | 25 | 40 | 80 | 35 | 48 |
| 66 6670 038 | 350 | 25 | 40 | 80 | 35 | 48 |
| 66 6602 038 | 350 | 30 | 55 | 90 | 35 | 51 |
| 66 6602 138 | 350 | 30 | 55 | 115 | 35 | 51 |
| 66 6670 099 | 200–1,200 | 25 | 40 | 80 | 35 | 48 |
| 66 6602 099 | 300–1,200 | 30 | 55 | 90 | 35 | 51 |

66 6670 034/037 not available in bronze
 66 6602 138 not available in aluminium
 M8 fixing
 S = safety clearance (see page 690)

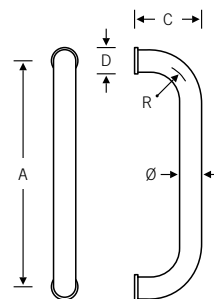

Fittings for entrance doors

Round door pulls

- Aluminium
- Stainless steel
- Bronze

66 6506



Pictured: right-hand model, outside view

66 6506 065 (R) | 66 6506 075 (L)

Grip cross-section \varnothing 35 mm
 M8 fixing
 Safety clearance $S = 47$ mm (see page 690)
 For handing, see page 75

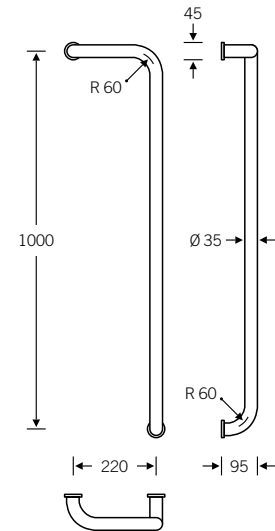

66 6507



Pictured: right-hand model, outside view

66 6507 065 (R) | 66 6507 075 (L)

Grip cross-section \varnothing 35 mm
 M8 fixing
 Safety clearance $S = 47$ mm (see page 690)
 For handing, see page 75

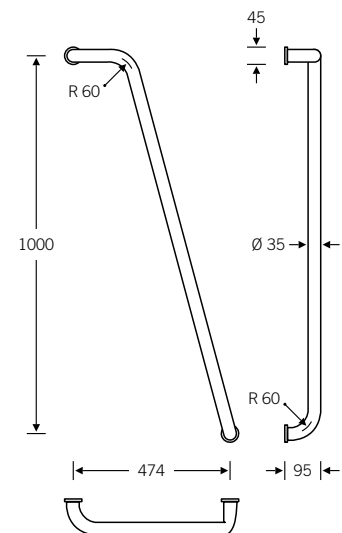

8a

Fittings for entrance doors

Round door pull

■ Aluminium
■ Stainless steel
■ Bronze

66 6514 ■

| Product code | A | Ø |
|--------------|-----|----|
| 66 6514 038 | 350 | 30 |
| 66 6514 045 | 450 | 30 |

M8 fixing
Safety clearance S = 55 mm
(see page 690)

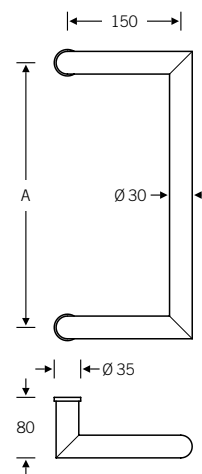

Fittings for entrance doors

Round door pull

■ Aluminium
■ Stainless steel
■ Bronze

66 6615 ■

| Product code | A | Ø | L |
|--------------|-----------|----|------|
| 66 6615 035 | 350 | 30 | 550 |
| 66 6615 045 | 450 | 30 | 650 |
| 66 6615 099 | 451–2,100 | 30 | var. |

Grip cross-section Ø 30 mm
M8 fixing

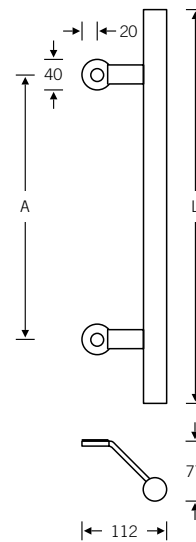

8a

FSB recommends a maximum bracket spacing of 1,200 mm.

Fittings for entrance doors

Round door pull

■ Aluminium
■ Stainless steel
■ Bronze

66 6526

| Product code | A | L |
|--------------|---|---|
|--------------|---|---|

| | | |
|-------------|-----|-----|
| 66 6526 035 | 350 | 570 |
|-------------|-----|-----|

| | | |
|-------------|-----|-----|
| 66 6526 045 | 450 | 670 |
|-------------|-----|-----|

Grip cross-section \varnothing 35 mm
Natural-colour aluminium brackets
M8 fixing

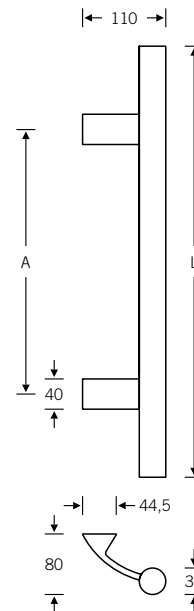

Fittings for entrance doors

Order form

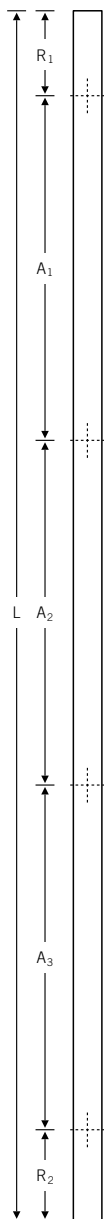
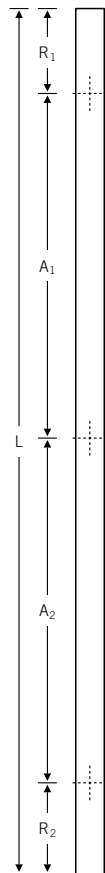
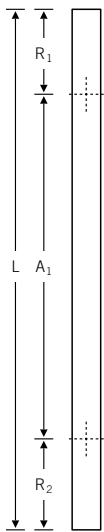

Please use a copy of this page when ordering door-pull series 66 6526 of variable length:

Enter details of quantities required and overall length in the table below. Please also indicate bracket spacings and the edge spacing in mm. Bracket spacings should not exceed 1,200 mm for reasons of stability.

66 6526 (Ø 35 mm)

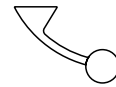

8a

| Qty | Length overall L | Bracket spacing | | | Edge spacing* | | Fixing type |
|-----|---------------------|-----------------|----------------|----------------|----------------|----------------|-------------|
| | | A ₁ | A ₂ | A ₃ | R ₁ | R ₂ | |
| | | | | | | | |
| | | | | | | | |
| | | | | | | | |

* min. 40 mm, max. 350 mm

Fittings for entrance doors

Round door pull

■ Aluminium
■ Stainless steel
■ Bronze

66 6541 ■

Stainless steel grip section,
aluminium neck
M8 fixing
Safety clearance $S = 51$ mm
(see page 690)

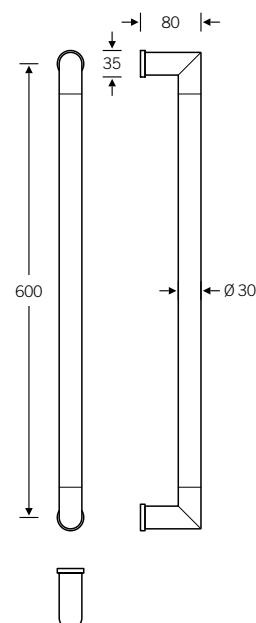
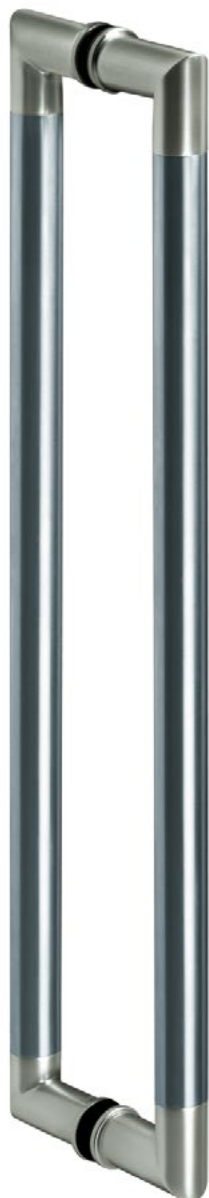

Fittings for entrance doors

Round door pull

- Aluminium
- Stainless steel
- Bronze

66 6546 

Matching FSB 1102
Bespoke lengths with bracket centres (A)
up to 1,200 mm
M8 fixing
Safety clearance S = 51 mm
(see page 690)

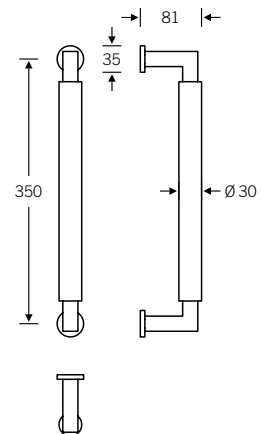

8a

Fittings for entrance doors

Round door pull

- Aluminium
- Stainless steel
- Bronze

66 6630 ■

Grip cross-section \varnothing 30 mm
Standard length 400 mm (also in bespoke lengths; see order form on next page)
M8 fixing

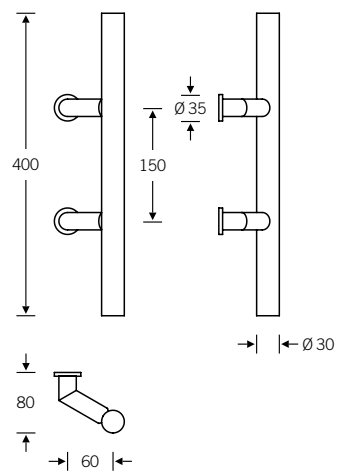

Fittings for entrance doors

Order form

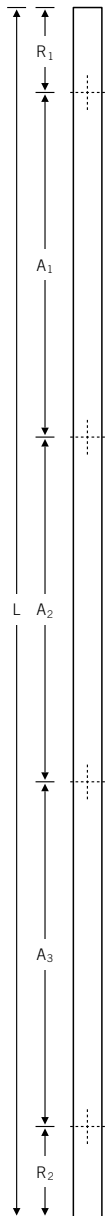
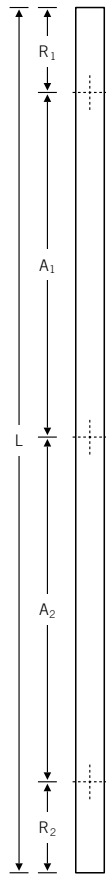

Please use a copy of this page when ordering door-pull series 66 6630 of variable length:

First tick the box next to the handle diameter for the variant desired. Enter details of quantities required and overall length in the table below.

Please also indicate bracket spacings and the edge spacing in mm. Bracket spacings should not exceed 1,200 mm for reasons of stability.

- 66 6630 (Ø 30 mm, gripping space depth 52 mm)
- 66 6630 (Ø 30 mm, gripping space depth 85 mm)
- 66 6531 (Ø 35 mm, gripping space depth 52 mm)
- 66 6532 (Ø 40 mm, gripping space space depth 52 mm)

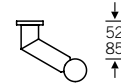



| Qty | Length overall L | Bracket spacing | | | Edge spacing* | | Fixing type |
|-----|---------------------|-----------------|----------------|----------------|----------------|----------------|-------------|
| | | A ₁ | A ₂ | A ₃ | R ₁ | R ₂ | |
| | | | | | | | |
| | | | | | | | |
| | | | | | | | |

* min. 30 mm, max. 350 mm

Fittings for entrance doors

Round door pulls



- Aluminium
- Stainless steel
- Bronze

66 6642  

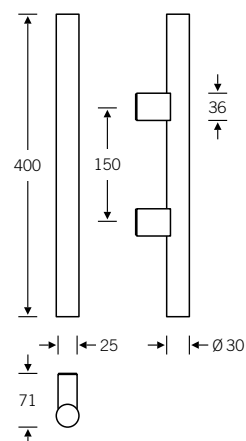

Grip cross-section \varnothing 30 mm
Natural-colour aluminium brackets
Aluminium or stainless steel grip section
Standard length 400 mm
M6 fixing
Safety clearance $S = 38$ mm
(see page 690)



66 6643  



Grip cross-section \varnothing 30 mm
Natural-colour aluminium brackets
Aluminium or stainless steel grip section
Standard length 400 mm
M6 fixing

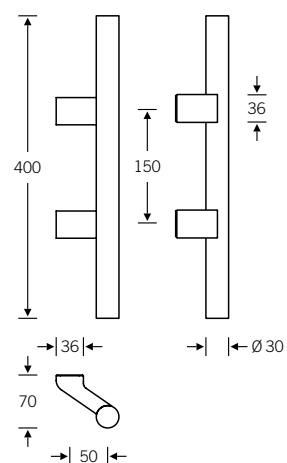

Fittings for entrance doors

Order form

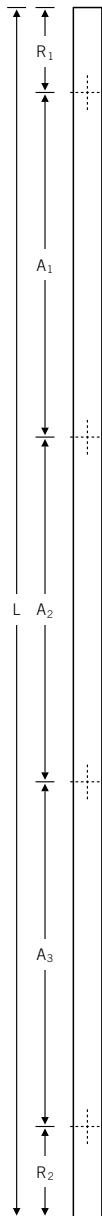
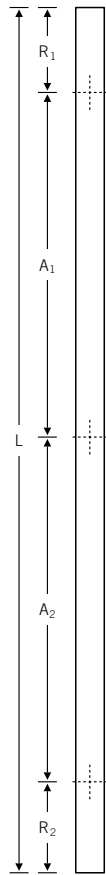

Please use a copy of this page when ordering door-pull series 66 6642 or 66 6643 of variable length:

First tick the box next to the product code for the variant desired. Enter details of quantities required and overall length in the table below.

Please also indicate bracket spacings and the edge spacing in mm. Bracket spacings should not exceed 1,200 mm for reasons of stability.

66 6642 099 (Ø 30 mm)



66 6643 099 (Ø 30 mm)



8a

| Qty | Length overall L | Bracket spacing | | | Edge spacing* | | Fixing type |
|-----|---------------------|-----------------|----------------|----------------|----------------|----------------|-------------|
| | | A ₁ | A ₂ | A ₃ | R ₁ | R ₂ | |
| | | | | | | | |
| | | | | | | | |
| | | | | | | | |

* min. 30 mm, max. 350 mm

Fittings for entrance doors

Round door pulls

- Aluminium
- Stainless steel
- Bronze

66 6653 ■



Grip cross-section \varnothing 30 mm
M8 fixing
Safety clearance $S = 55$ mm
(see page 690)

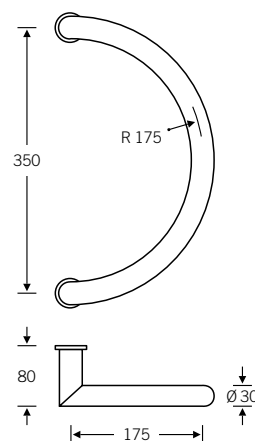

66 6655 ■



Grip cross-section \varnothing 35 mm
M8 fixing
Safety clearance $S = 55$ mm
(see page 690)

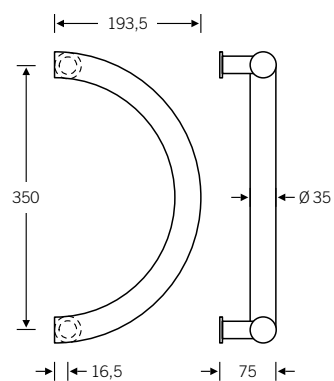

Fittings for entrance doors

Round door pull

■ Aluminium
■ Stainless steel
■ Bronze

66 6662

| Product code | A | ∅ | R | B | C | D | S |
|--------------|-----------|----|----|-----|-----|----|----|
| 66 6661 034 | 200 | 25 | 40 | 100 | 80 | 35 | 42 |
| 66 6661 037 | 300 | 25 | 40 | 100 | 80 | 35 | 42 |
| 66 6661 038 | 350 | 25 | 40 | 100 | 80 | 35 | 42 |
| 66 6662 038 | 350 | 30 | 55 | 140 | 90 | 35 | 43 |
| 66 6662 138 | 350 | 30 | 55 | 140 | 115 | 35 | 43 |
| 66 6663 038 | 350 | 35 | 60 | 140 | 95 | 45 | 45 |
| 66 6661 099 | 200–1,200 | 25 | 40 | 100 | 80 | 35 | 42 |
| 66 6662 099 | 300–1,200 | 30 | 55 | 140 | 90 | 35 | 43 |
| 66 6663 099 | 300–1,200 | 35 | 60 | 140 | 95 | 45 | 45 |



Only 66 6662 038 is available in bronze
 66 6662 138 not available in aluminium and bronze
 M8 fixing
 S = safety clearance (see page 690)

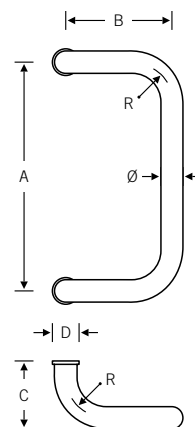

8a

Fittings for entrance doors

Round door pull

- Aluminium
- Stainless steel
- Bronze

66 6669

| Product code | A | ∅ | C | D | S |
|--------------|----------------|----|----|----|----|
| 66 6669 038 | 350 | 30 | 80 | 35 | 55 |
| 66 6606 038 | 350 | 25 | 75 | 35 | 50 |
| 66 6669 099 | Bespoke length | 30 | | | |

Bespoke lengths with bracket centres (A) up to 1,200 mm
M8 fixing
S = safety clearance (see page 690)
Bronze in ∅ 30 mm (66 6669 038) only

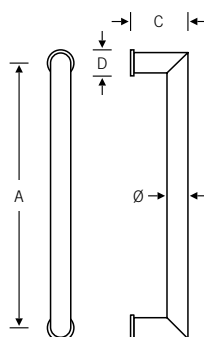

Fittings for entrance doors

Round door pull

- Aluminium
- Stainless steel
- Bronze

66 6674 ■

| Product code | A | Ø | R | B | L |
|--------------|-----|----|------|-----|-----|
| 66 6674 021 | 210 | 30 | 485 | 126 | 497 |
| 66 6674 035 | 350 | 30 | 1420 | 123 | 742 |

M8 fixing

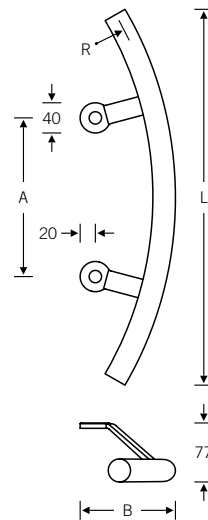

8a

Fittings for entrance doors

Round door pull

- Aluminium
- Stainless steel
- Bronze

66 6623 ■

Grip cross-section $\varnothing 30$
M8 fixing
Safety clearance $S = 43$ mm
(see page 690)

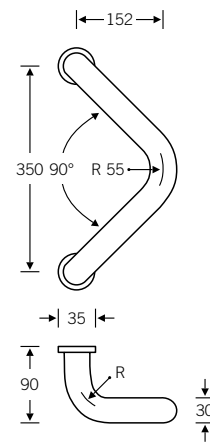

Fittings for entrance doors

Round door pull

■ Aluminium
■ Stainless steel
■ Bronze

66 6683 ■

| Product code | A | Ø | R1 | R2 | B | C | D | S |
|--------------|-----|----|-----|----|-----|----|----|----|
| 66 6673 034 | 200 | 25 | 100 | 40 | 140 | 80 | 35 | 42 |
| 66 6673 037 | 300 | 25 | 150 | 40 | 190 | 80 | 35 | 42 |
| 66 6673 038 | 350 | 25 | 175 | 40 | 215 | 80 | 35 | 42 |
| 66 6683 038 | 350 | 30 | 175 | 55 | 230 | 90 | 35 | 43 |
| 66 6659 038 | 350 | 35 | 175 | 60 | 235 | 95 | 45 | 45 |

M8 fixing
 S = safety clearance
 (see page 690)

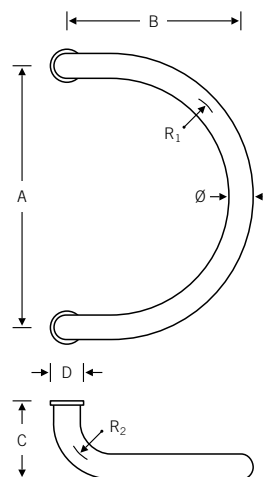

8a

Fittings for entrance doors

Round door pull

■ Aluminium
■ Stainless steel
■ Bronze

66 6681 

Grip cross-section \varnothing 30 mm
Standard length 400 mm (also in bespoke lengths; see order form on next page)
M8 fixing
Safety clearance $S = 38$ mm
(see page 690)

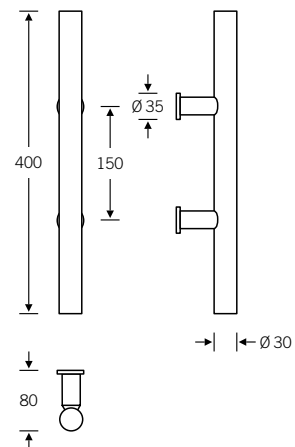

Fittings for entrance doors

Order form

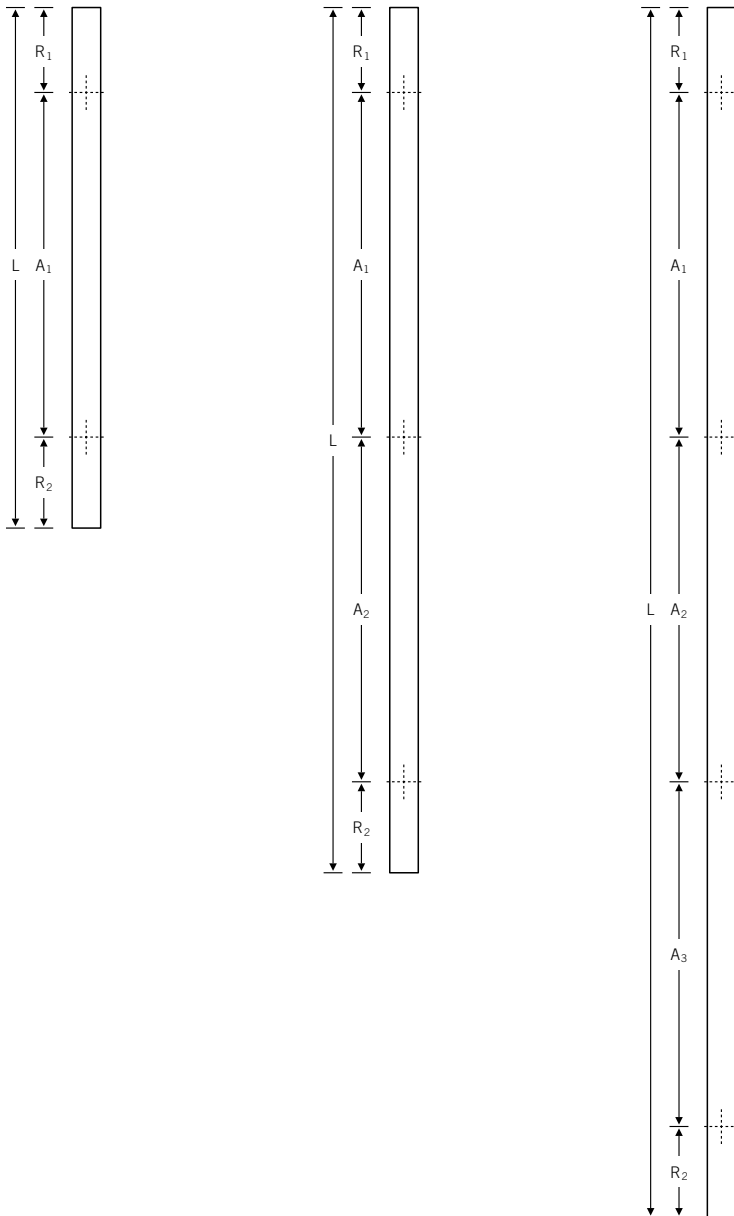

Please use a copy of this page when ordering door-pull series 66 6681 of variable length:

First tick the box next to the handle diameter for the variant desired. Enter details of quantities required and overall length in the table below.

Please also indicate bracket spacings and the edge spacing in mm. Bracket spacings should not exceed 1,200 mm for reasons of stability.

- 66 6580 (Ø 25 mm, gripping space depth 51 mm)
- 66 6681 (Ø 30 mm, gripping space depth 51 mm)
- 66 6681 (Ø 30 mm, gripping space depth 85 mm*)
- 66 6582 (Ø 35 mm, gripping space depth 51 mm)
- 66 6583 (Ø 40 mm, gripping space depth 51 mm)



8a

| Qty | Length overall L | Bracket spacing | | | Edge spacing** | | Fixing type |
|-----|---------------------|-----------------|----------------|----------------|----------------|----------------|-------------|
| | | A ₁ | A ₂ | A ₃ | R ₁ | R ₂ | |
| | | | | | | | |
| | | | | | | | |
| | | | | | | | |

* Stainless steel only
** min. 30 mm, max. 350 mm

Fittings for entrance doors

Round welded ht door pulls

- Aluminium
- Stainless steel
- Bronze

66 6522

66 6523

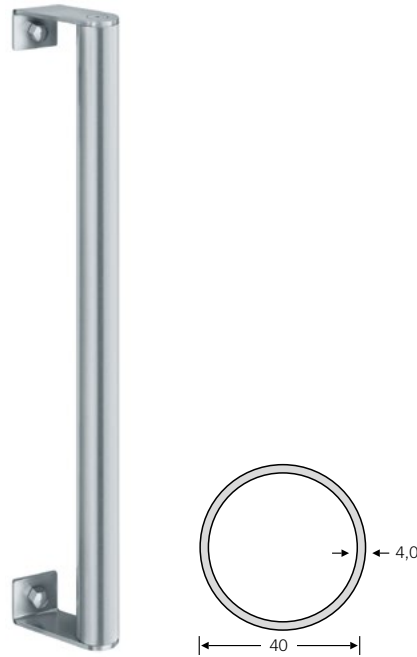
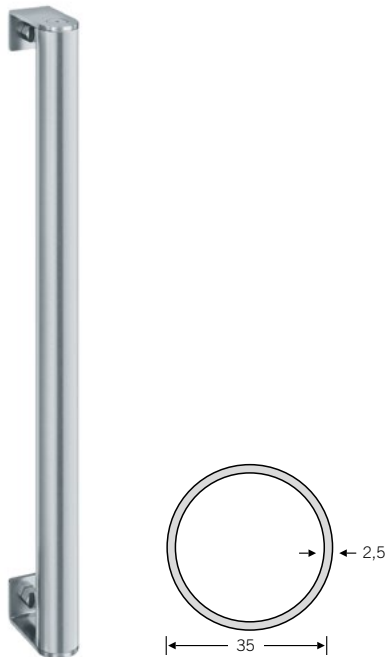

66 6522
Bracket centres (A) 1,000 mm to 2,600 mm
Tube Ø 35 × 2.5 mm

66 6523
Bracket centres (A) 2,100 mm to 2,800 mm
Tube Ø 40 × 4 mm

- Works-welded
- Made to order
- Desired **bracket combinations** (see below) are expressed by combining numbers, e.g. 66 6522 **5656**
- Bronze variant only available with bracket combinations 45 or 46/56
- The bracket spacing (A) is measured from the centre of the screw hole of one bracket to the centre of the screw hole of the other bracket; the tube length of the door pull is determined by adding or subtracting the differential dimensions provided on page 677 prior to welding the parts together at the plant.

Bracket combinations

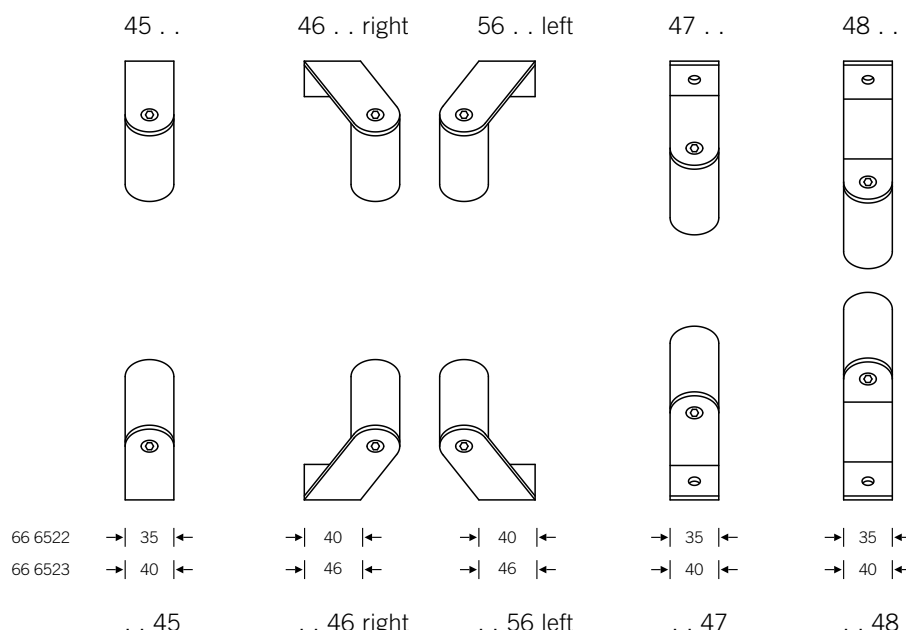

When using oval ht door pulls (for self-assembly or in the works-welded variant), structural requirements and conditions on site must be considered. These handles are no substitute for gymnastic bars and

must not be used as safety barriers at hazardous building openings. If in doubt please consult the architect or structural engineer in charge. Fixing system details can be found on page 691 ff.

Fittings for entrance doors

Door pull from the round ht kit

- Aluminium
- Stainless steel
- Bronze

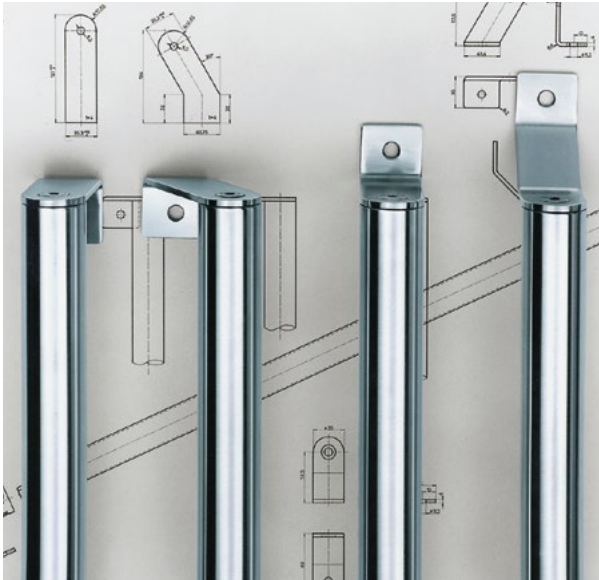

66 6801 ■

Tube $\varnothing 35 \times 1.5$ mm
Lengths up to 1,500 mm

- High degree of flexibility, such as on the construction site
- Handle systems, handrails, safety rails, etc. can be cut to size on site, configured and installed from FSB tubes and brackets
- We recommend works-welded variant FSB 66 6522 when bracket centres (A) measure 1,500 mm or more; see previous page
- For bracket centres (A) measuring 2,100 mm upwards, welded variant FSB 66 6522 is available; see page 676

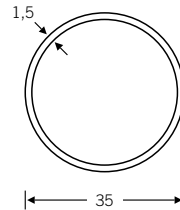

Cut-to-size dimensions and bracket combinations

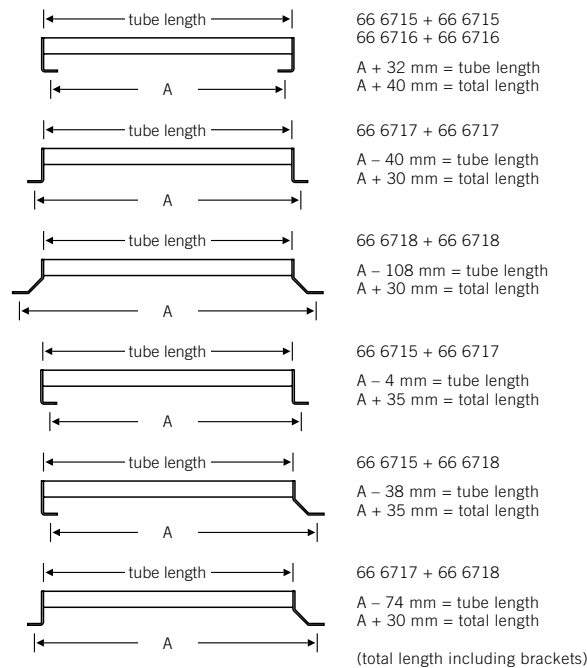

The tube length and bracket centres (A) have an important bearing on manufacturing, installation and ordering. The bracket spacing (A) is measured from the centre of the screw hole of one bracket to the centre of the screw hole of the other bracket. The tube length is calculated from the bracket centres (A) by adding or subtracting the differential dimensions provided here.

8a

When using oval ht door pulls (for self-assembly or in the works-welded variant), structural requirements and conditions on site must be considered. These handles are no substitute for gymnastic bars and

must not be used as safety barriers at hazardous building openings. If in doubt please consult the architect or structural engineer in charge. Fixing system details can be found on page 691 ff.

Fittings for entrance doors

Door-pull brackets from the round ht kit

- Aluminium
- Stainless steel
- Bronze

66 6715

In-line bracket, joint angled 90° inwards, suitable for tube Ø 35 × 1.5 mm

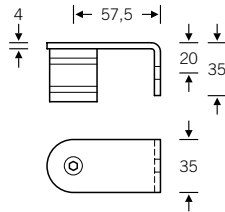

66 6716

66 6716 014 (R) | 66 6716 015 (L)

Cranked 45° bracket, joint angled 90° inwards, suitable for tube Ø 35 × 1.5 mm; pictured: right-hand model

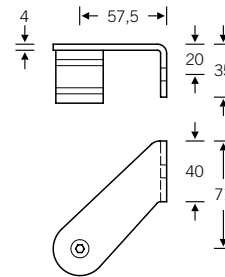

66 6717

In-line bracket, joint angled 90° outwards, suitable for tube Ø 35 × 1.5 mm

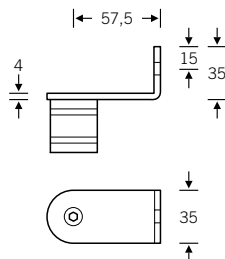

66 6718

Bracket for swing doors, suitable for tube Ø 35 × 1.5 mm

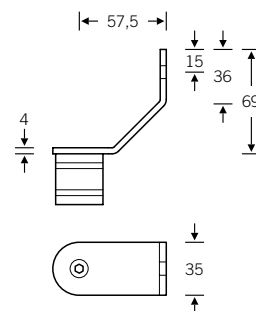

Screw hole Ø 8.5 mm
Safety clearance S = 52 mm
(see page 690)

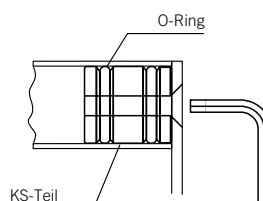

Once the tube has been cut to size (bracket centres A +/- differential dimension), the expansion plugs for the brackets selected are inserted into the two ends of the tube and activated by screwing them in at the top.

Fittings for entrance doors

Door-pull accessories from the round ht kit

In the case of door pulls from the round ht kit that are used on high-traffic doors or with bracket centres (A) measuring 1,500 – 2,100 mm, FSB recommends reinforcing them with the aid of the dedicated accessories presented here – or even better, opting for works-welded variants FSB 66 6522 or 66 6523 (see page 676).

Assembly instructions: cut the hollow steel bar to a length equal to that of the pull tube minus 100 mm. Slide spacer sleeves over the bar at intervals of 350 mm and secure. Insert the assembly into the pull tube and fit the hardware.

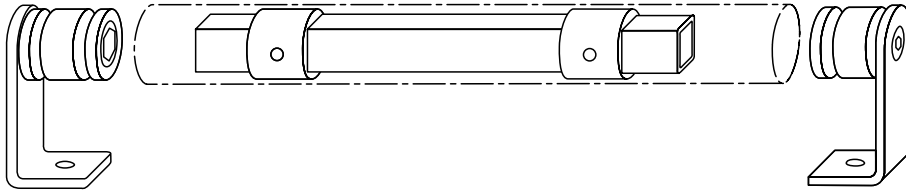

66 6801

Hot-dip galvanised hollow steel bar

66 6801 02020

20 × 20 × 2 mm
Stock length supplied 3,000 mm

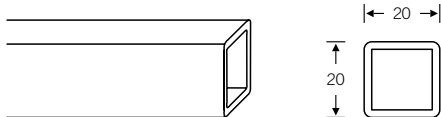

66 6719

Plastic

Spacer sleeve with securing screw

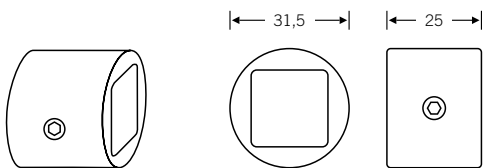

05 03..

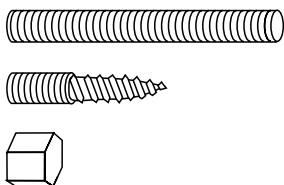

05 0313 00880 (M8 × 80 mm)
Grub screw

05 0316 00840 (M8)
Headless wood screw

05 0320 00800 (M8)
Stainless steel domed nut

Fittings for entrance doors

Half-round door pull

- Aluminium
- Stainless steel
- Bronze

66 6550 ■

M8 fixing
Safety clearance S = 51
(see page 690)

66 6550 02194 (X = 210 mm)
66 6550 06094 (X = 600 mm)

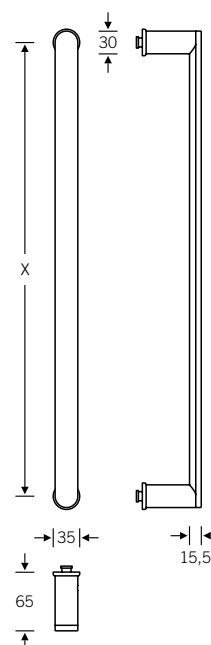
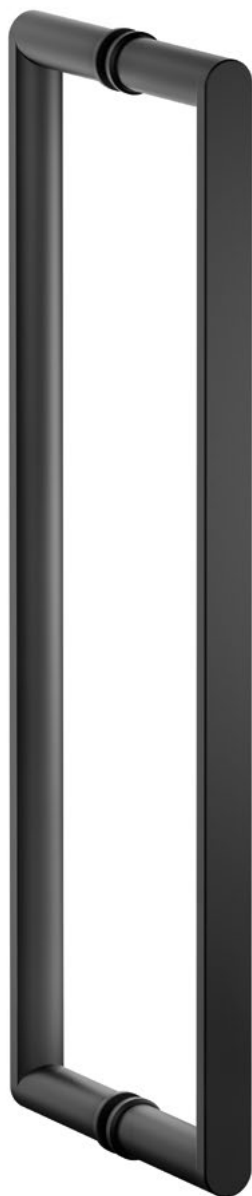

Fittings for entrance doors

Half-round door pull

- Aluminium
- Stainless steel
- Bronze

66 6551 ■

M8 fixing
Safety clearance S = 55
(see page 690)

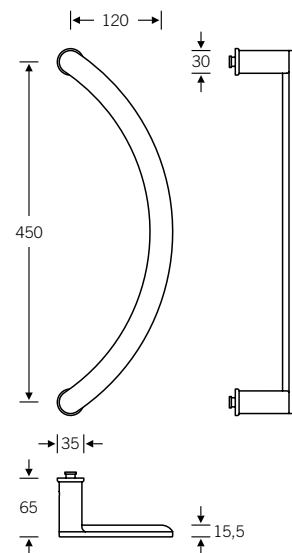

8a

Fittings for entrance doors

Half-round door pull

- Aluminium
- Stainless steel
- Bronze

66 6552 ■

66 6552 44594 (R)
66 6552 54594 (L)

M8 fixing
Safety clearance S = 43
(see page 690)



Pictured: right-hand model,
outside view

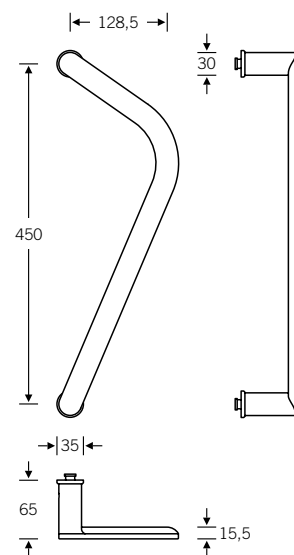

Fittings for entrance doors

Half-sets

■ Aluminium
■ Stainless steel
■ Bronze

70 1003 



↻ 70 1003 00604 (R) | 70 1003 00605 (L)

Spindle 8 mm

70 1004 



↻ 70 1004 00604 (R) | 70 1004 00605 (L)

Spindle 8 mm

70 1005 



↻ 70 1005 00504 (R) | 70 1005 00505 (L)

Spindle 8 mm

70 1015 



↻ 70 1015 00504 (R) | 70 1015 00505 (L)

Spindle 8 mm

70 1023 



↻ 70 1023 00504 (R) | 70 1023 00505 (L)

Spindle 8 mm

70 1035 



↻ 70 1035 00604 (R) | 70 1035 00605 (L)

Spindle 8 mm

Lever handles with FSB AGL® technology for face fixing to front doors, with a rugged base and positive mechanism. The required half-spindles 05 0115 or 05 0116 can be found on page 765.

↻ FSB ASL®
↻ FSB AGL®
↻ FS heavy-duty fitting
↻ EN 179 heavy-duty fitting
For bearings, see page 52 ff.

8a

Fittings for entrance doors

Half-sets

■ Aluminium
■ Stainless steel
■ Bronze

70 1070 



↻ 70 1070 00504 (R) | 70 1070 00505 (L)

Spindle 8 mm

70 1076 



↻ 70 1076 00504 (R) | 70 1076 00505 (L)

Spindle 8 mm

70 1102 



↻ 70 1102 00604 (R) | 70 1102 00605 (L)

Spindle 8 mm

70 1107 



↻ 70 1107 00504 (R) | 70 1107 00505 (L)

Spindle 8 mm

70 1108 



↻ 70 1108 00504 (R) | 70 1108 00505 (L)

Spindle 8 mm

70 1146 



↻ 70 1146 00504 (R) | 70 1146 00505 (L)

Spindle 8 mm

Lever handles with FSB AGL® technology for face fixing to front doors, with a rugged base and positive mechanism. The required half-spindles 05 0115 or 05 0116 can be found on page 765.

↻ FSB ASL®

↻ FSB AGL®

↻ FS heavy-duty fitting

↻ EN 179 heavy-duty fitting

For bearings, see page 52 ff.

Fittings for entrance doors

Half-sets

■ Aluminium
■ Stainless steel
■ Bronze

70 1147 ■ ■



↻ 70 1147 00504 (R) | 70 1147 00505 (L)

Spindle 8 mm

70 1163 ■



↻ 70 1163 00604 (R) | 70 1163 00605 (L)

Spindle 8 mm

70 1183 ■ ■



↻ 70 1183 00604 (R) | 70 1183 00605 (L)

Spindle 8 mm

03 0418 ■ ■

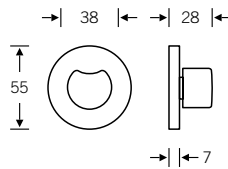

03 0418 00208

Spindle 8 mm
 Standard spindle projection 40 mm,
 custom spindle projections possible,
 easy-action thumb turn on round rose with
 concealed face fixing for use on multipoint
 locking systems

03 0418 ■ ■ ■

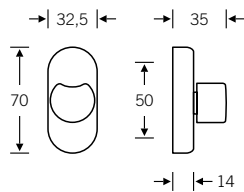

03 0418 00308

Spindle 8 mm
 Standard spindle projection 40 mm,
 custom spindle projections possible

8a

Lever handles with FSB AGL® technology for face fixing to front doors, with a rugged base and positive mechanism. The required half-spindles 05 0115 or 05 0116 can be found on page 765.

↻ FSB ASL®
 ↻ FSB AGL®
↻ FS heavy-duty fitting
↻ EN 179 heavy-duty fitting
 For bearings, see page 52 ff.

Fittings for entrance doors

Letter plates

38 3826 

38 3826 02061 (40 – 70 mm)
38 3826 02071 (71 – 100 mm)

Letter plate set with spacer and door tidy
Aperture dimensions 230 × 40 mm
Door cut-out 240 × 50 mm

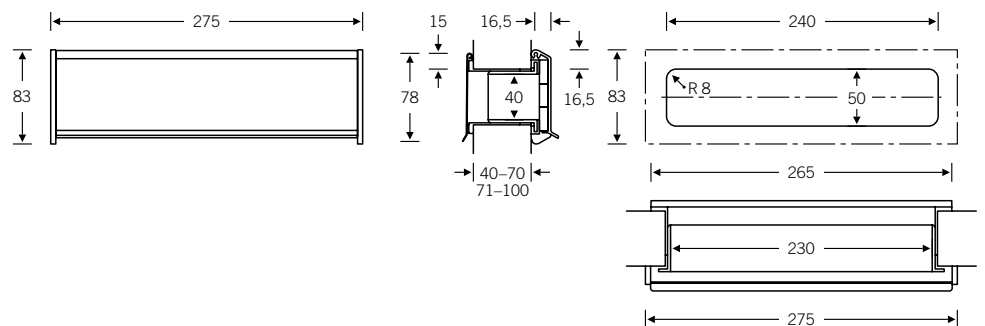



Fixing separate for letter plate and door tidy

Fittings for entrance doors

Letter plates

■ Aluminium
■ Stainless steel
■ Bronze

38 3826 
38 3829 

38 3826 02001
Letter plate dimensions or door cut-out
230 × 40 mm

38 3829 02001
Letter plate dimensions or door cut-out
325 × 40 mm

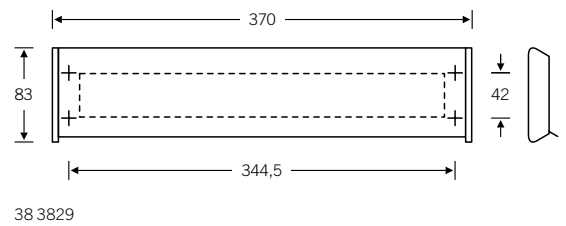
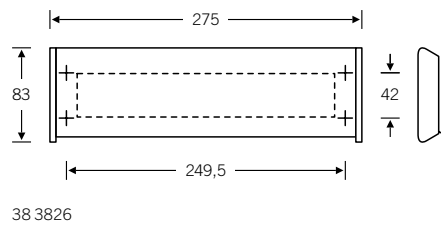

Custom inscriptions:

Using laser engraving or digital printing, FSB can put illustrations, graphics, motifs, decorations, letters and numbers on aluminium or stainless steel letter plates. For further information, see page 690



Pictured: letter plate 38 3829 with inscriptions in font 'Blair Medium'

8a

689 **Technical information**
Fittings for entrance doors

Technical information

Door pulls

Queries

Always specify the door type and material in your query. Accurately dimensioned drawings are required for both quoting and manufacturing purposes. For door handing, see page 75.

Door pulls: in pairs or singles?

We show door pulls in pairs to facilitate an understanding of their technology and design. This allows the reverse face and geometric configuration to be seen. Naturally we also supply door pulls as single items.

Installation

Door pulls can be either face or through-fixed to doors made of the most diverse materials.

In the case of through-fixing, either a pair of door pulls or a single handle can be fitted. FSB provides straightforward illustrations of these three fixing options – back-to-back, bolt through-fixing and face fixing with threaded insert – below.

As regards the issue of face fixing versus bolt through-fixing, FSB uses the threaded insert technique because it results in face fixing that, thanks to the FSB fixing system, is generally both aesthetically pleasing and sufficiently durable. Nevertheless, there is a caveat where heavy-duty applications are concerned (e.g. in schools, administrative buildings and other public establishments): in this case we emphatically recommend bolt through-fixing, which ensures that the door pull remains fit for purpose even after years of heavy treatment, since the forces involved are absorbed on both sides of the door.

Safety clearance (S)

When fitting a door pull to the closing face of a door, a safety clearance must be provided between the grip section and the edge of the door or the jamb. The diagram below illustrates the positioning. Ideally, the safety clearances as recommended by FSB should be adhered to. On-site conditions will determine the most appropriate course of action, however.

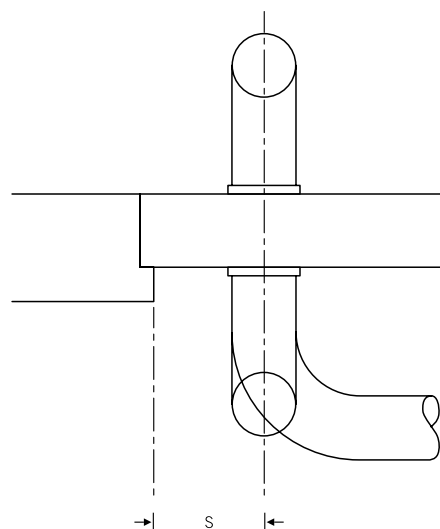

Fixing back-to-back

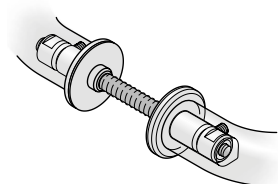

Fixing bolt through-fixing

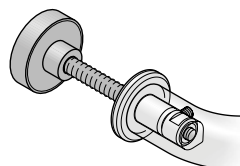

Fixing face fixing with threaded insert

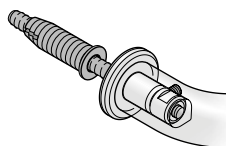

Technical information

Fixing door pulls



Fixing door pulls with self-tapping threaded insert

FSB's threaded insert system offers a practice-oriented and, at the same time, enhanced solution for the concealed face fixing of door pulls to timber, aluminium and PVC doors, which also guarantees far more effective absorption of tensile forces by the door stile.

Threaded inserts measuring 34, 45 or 58 mm in length are used, depending on the door thickness or type of stile.

As it is inserted, the self-tapping thread establishes an ideal connection between the door stile and insert, with comparatively low tolerances, which ensures even and effective positive locking – assuming a drill hole measuring precisely 12.5 mm in diameter for timber doors or precisely 13 mm in diameter for metal and PVC doors has been created.

First step

Mechanically or manually, drill holes with a diameter of 12.5 mm (timber doors) or 13 mm (metal and PVC doors) to accommodate the FSB threaded inserts.

Second step

The self-tapping threaded inserts are then screwed into place using an 8 mm Allen key. FSB recommends using an Allen key with a handle, as this offers the best possible application of the requisite forces. The grub screw supplied is screwed in once the threaded insert is flush with the stile.

Third step

The door pull can now be secured at these fixing points.

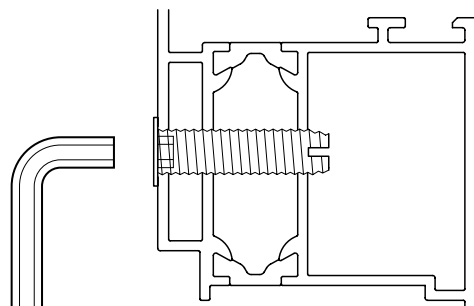

8a

Technical information

Drilling dimensions

Glass doors

Timber doors

Metal doors

PVC doors

For fixing options, see A

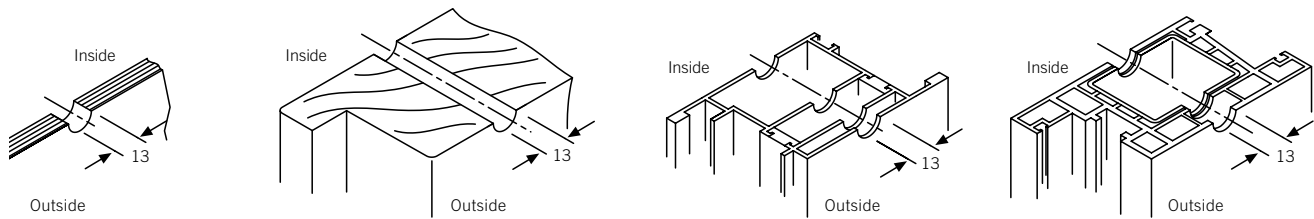

For fixing options, see B

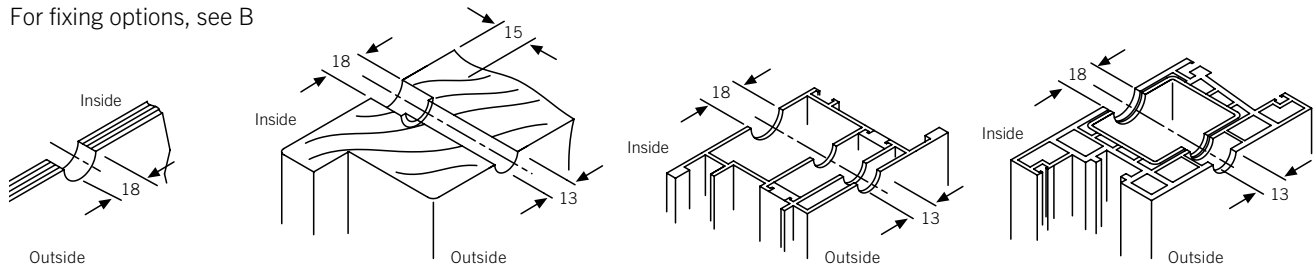

For fixing options, see C

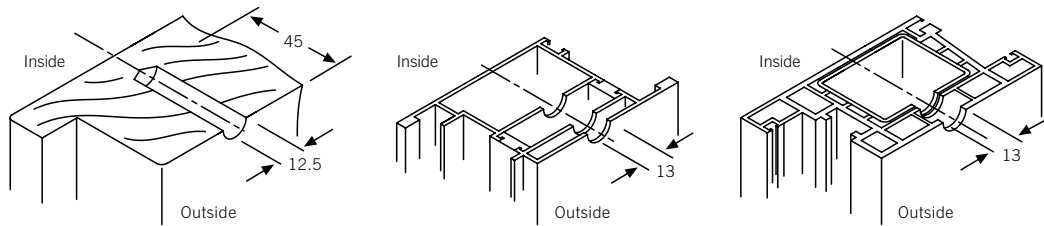

Fixing A

back-to-back:
05 0580, 05 0582, 05 0583,
05 0585, 05 0587

Fixing B

bolt through-fixing:
05 0580, 05 0582, 05 0583,
05 0585, 05 0587

Fixing C

face fixing with threaded insert:
all products

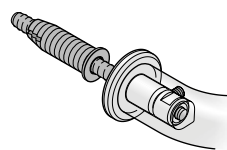
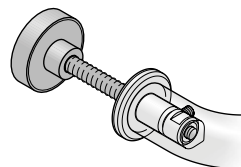
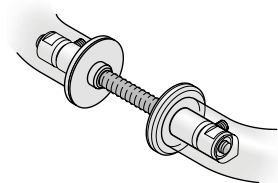

Technical information

Fixing door pulls

Door pull

66 6635

When selecting and ordering door pulls and the fixing type, keep in mind that the door pulls in this series are manufactured as threaded and through-fixing components.

Fixing type

back-to-back

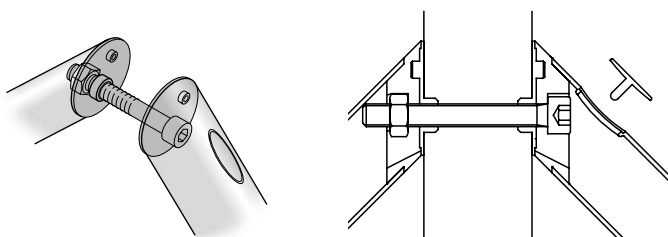

Fixing accessories

Drill hole \varnothing 13 mm
2 × M8 cheese head screws
4 × plastic washers
2 × stainless steel handle caps

05 0582 01008 (8–10 mm, glass door)
05 0582 03038 (38–44 mm)
05 0582 03045 (45–49 mm)
05 0582 03050 (50–54 mm)
05 0582 03055 (55–59 mm)
05 0582 03060 (60–64 mm)
05 0582 03065 (65–69 mm)
05 0582 03070 (70–74 mm)
05 0582 03075 (75–79 mm)
05 0582 03080 (80–84 mm)

bolt through-fixing

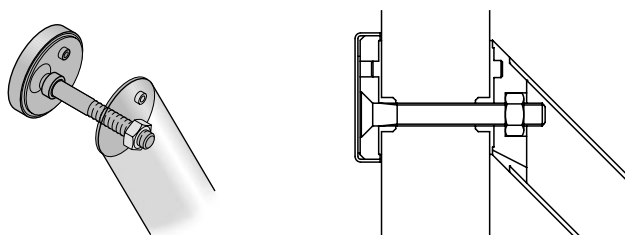

Drill hole \varnothing 13 mm
2 × M8 countersunk screws
4 × plastic washers
2 × fixing discs with stainless steel cover caps

05 0582 02008 (8–10 mm, glass door)
05 0582 04038 (38–44 mm)
05 0582 04045 (45–49 mm)
05 0582 04050 (50–54 mm)
05 0582 04055 (55–59 mm)
05 0582 04060 (60–64 mm)
05 0582 04065 (65–69 mm)
05 0582 04070 (70–74 mm)
05 0582 04075 (75–79 mm)
05 0582 04080 (80–84 mm)

face fixing with threaded insert

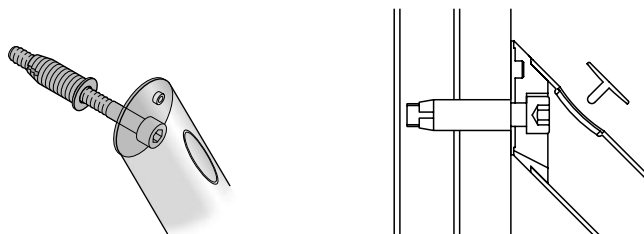

Drill hole \varnothing 12.5 mm (timber doors)
Drill hole \varnothing 13 mm (metal/PVC doors)
2 × M8 cheese head screws
2 × plastic washers
2 × self-tapping threaded inserts in hardened galvanised steel
2 × stainless steel handle caps

05 0582 00335 (X: 10–30 mm, plug length 38 mm)
05 0582 00336 (X: 10–41 mm, plug length 45 mm)
05 0582 00337 (X: 10–54 mm, plug length 58 mm)

X = cavity dimension

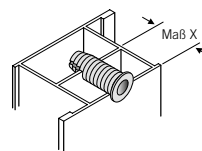

8a

Technical information

Fixing door pulls

Round M8 door pulls

66 6506, 66 6507, 66 6514, 66 6531, 66 6532, 66 6533,
66 6535, 66 6536, 66 6537, 66 6538, 66 6540, 66 6541,
66 6542, 66 6546, 66 6550, 66 6551, 66 6552, 66 6580,
66 6582, 66 6583, 66 6602, 66 6623, 66 6630, 66 6650,
66 6550, 66 6551, 66 6552, 66 6652, 66 6653, 66 6655,
66 6659, 66 6661, 66 6662, 66 6663, 66 6669, 66 6670,
66 6673, 66 6681, 66 6683

Fixing type

back-to-back

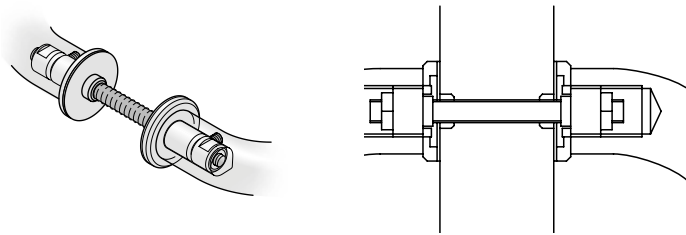

Fixing accessories

Drill hole \varnothing 13 mm
2 \times M8 threaded studs

05 0580 01008 (8–10 mm, glass door)
05 0580 03035 (35–54 mm)
05 0580 03055 (55–74 mm)
05 0580 03075 (75–94 mm)
05 0580 03095 (95–114 mm)

bolt through-fixing

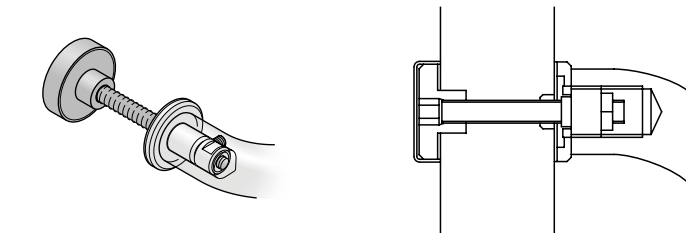

Drill hole \varnothing 13/18 mm, see page 692
2 \times M8 threaded studs
2 \times fastening nuts with cover caps

Handle diameter 25/30 mm:
05 0580 02308 (8–10 mm, glass door)
05 0580 04335 (35–44 mm)
05 0580 04345 (45–54 mm)
05 0580 04355 (55–64 mm)
05 0580 04365 (65–74 mm)
05 0580 04375 (75–84 mm)
Handle diameter 35/40 mm:
05 0580 02408 (8–10 mm, glass door)
05 0580 04435 (35–44 mm)
05 0580 04445 (45–54 mm)
05 0580 04455 (55–64 mm)
05 0580 04465 (65–74 mm)
05 0580 04475 (75–84 mm)

face fixing with threaded insert

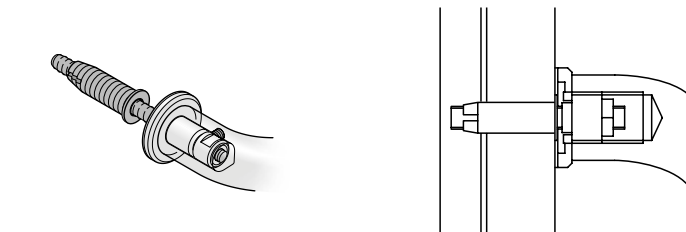

Drill hole \varnothing 12.5 mm (timber doors)
Drill hole \varnothing 13 mm (metal/PVC doors)
2 \times M8 grub screws
2 \times self-tapping threaded inserts in hardened
galvanised steel

05 0580 00335 (X: 10–30 mm, plug length 38 mm)
05 0580 00336 (X: 10–41 mm, plug length 45 mm)
05 0580 00337 (X: 10–54 mm, plug length 58 mm)

X = cavity dimension

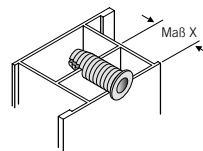

Technical information

Fixing door pulls

Round M6 door pulls

66 6612

Fixing type

back-to-back

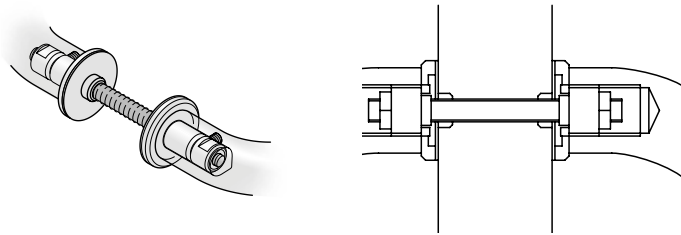

Fixing accessories

Drill hole \varnothing 13 mm
2 \times M6 threaded studs

05 0580 01208 (8–10 mm, glass door)
05 0580 03235 (35–54 mm)
05 0580 03255 (55–74 mm)
05 0580 03275 (75–94 mm)

bolt through-fixing

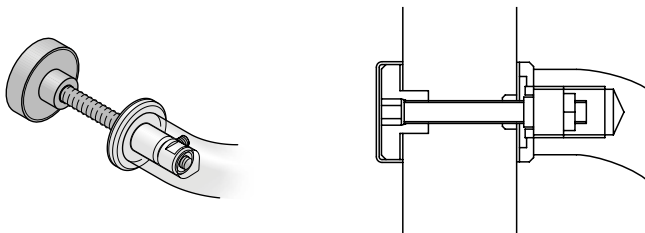

Drill hole \varnothing 13/18 mm, see page 692
2 \times M6 threaded studs
2 \times fastening nuts with cover caps

Handle diameter 20/25 mm:
05 0580 02208 (8–10 mm, glass door)
05 0580 04235 (35–44 mm)
05 0580 04245 (45–54 mm)
05 0580 04255 (55–64 mm)
05 0580 04265 (65–74 mm)
05 0580 04275 (75–84 mm)

face fixing with threaded insert

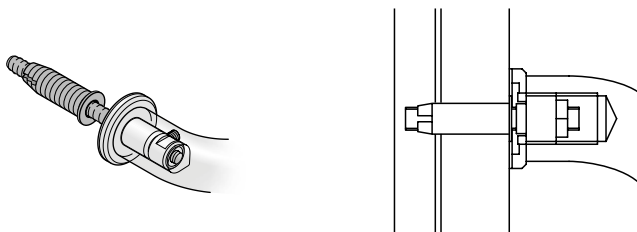

Drill hole \varnothing 12.5 mm (timber doors)
Drill hole \varnothing 13 mm (metal/PVC doors)
2 \times M6 grub screws
2 \times self-tapping threaded inserts in hardened galvanised steel

05 0580 00435 (X: 10–30 mm, plug length 38 mm)
05 0580 00436 (X: 10–41 mm, plug length 45 mm)
05 0580 00437 (X: 10–54 mm, plug length 58 mm)

X = cavity dimension

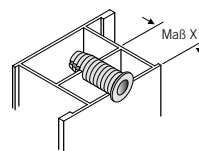

Technical information

Fixing door pulls

Door pulls

66 6615, 66 6616, 66 6674, 66 6675

Fixing type

back-to-back

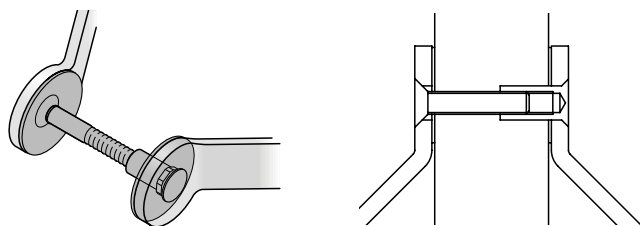

Fixing accessories

Drill hole \varnothing 13 mm
2 x M8 countersunk screws with stainless steel
M8 cap nuts
4 x plastic washers

05 0583 01008 (8–10 mm, glass door)
05 0583 03034 (34–43 mm)
05 0583 03044 (44–53 mm)
05 0583 03054 (54–63 mm)
05 0583 03064 (64–73 mm)
05 0583 03074 (74–83 mm)

bolt through-fixing

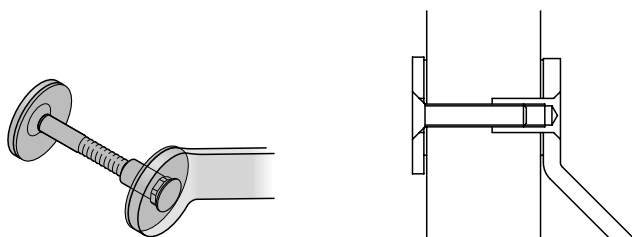

Drill hole \varnothing 13 mm
2 x M8 countersunk screws with stainless steel
M8 cap nuts
2 x stainless steel washers
4 x plastic washers

05 0583 02008 (8–10 mm, glass door)
05 0583 04036 (36–45 mm)
05 0583 04046 (46–55 mm)
05 0583 04056 (56–65 mm)
05 0583 04066 (66–75 mm)
05 0583 04076 (76–85 mm)

face fixing with threaded insert

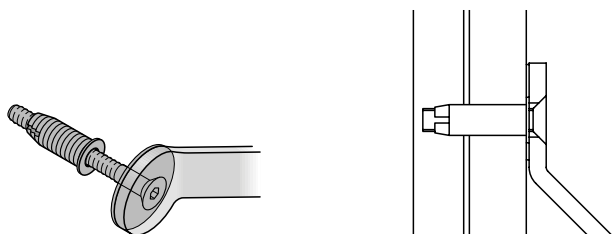

Drill hole \varnothing 12.5 mm (timber doors)
Drill hole \varnothing 13 mm (metal/PVC doors)
2 x stainless steel M8 countersunk screws
2 x self-tapping threaded inserts in hardened galvanised steel
2 x plastic washers

05 0583 00335 (X: 10–30 mm, plug length 38 mm)
05 0583 00336 (X: 10–41 mm, plug length 45 mm)
05 0583 00337 (X: 10–54 mm, plug length 58 mm)

X = cavity dimension

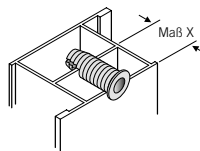

Technical information

Fixing door pulls

Door pulls and push/pull pad handles

61 6108, 61 6186, 61 6187, 61 6188, 66 6519,
66 6520, 66 6526, 66 6548

Fixing type

back-to-back

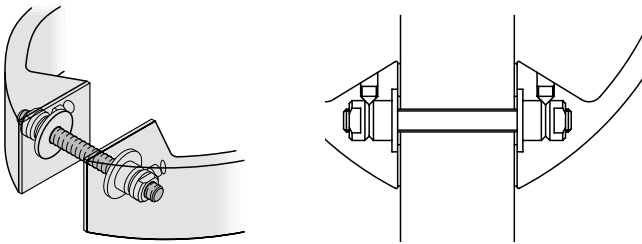

Fixing accessories

Drill hole \varnothing 13 mm
2 \times M8 threaded studs

05 0587 01008 (8–10 mm)
05 0587 03035 (35–54 mm)
05 0587 03055 (55–74 mm)
05 0587 03075 (75–94 mm)

bolt through-fixing

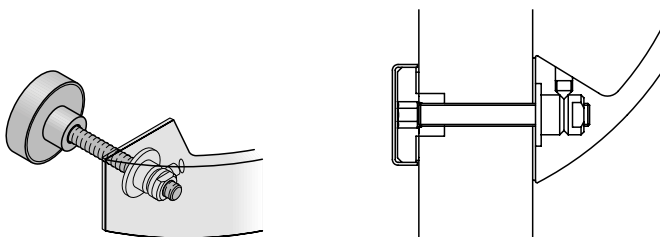

Drill hole \varnothing 13/18 mm, see page 692
2 \times M8 threaded studs
2 \times fastening nuts with cover caps

05 0587 02308 (8–10 mm)
05 0587 04335 (35–44 mm)
05 0587 04345 (45–54 mm)
05 0587 04355 (55–64 mm)
05 0587 04365 (65–74 mm)
05 0587 04375 (75–84 mm)

face fixing with threaded insert

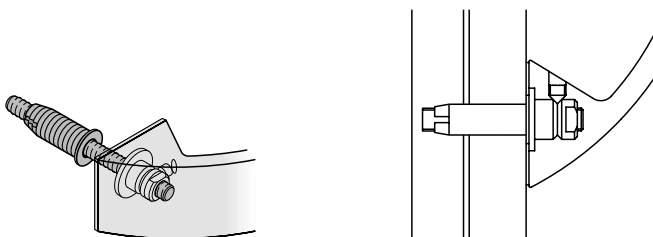

Drill hole \varnothing 12.5 mm (timber doors)
Drill hole \varnothing 13 mm (metal/PVC doors)
2 \times M8 grub screws
2 \times self-tapping threaded inserts in hardened
galvanised steel

05 0587 00335 (X: 10–30 mm, plug length 38 mm)
05 0587 00336 (X: 10–41 mm, plug length 45 mm)
05 0587 00337 (X: 10–54 mm, plug length 58 mm)

X = cavity dimension

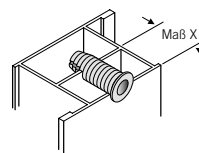

Technical information

Fixing door pulls

Door pulls and push/pull pad handles

61 6112, 66 6642, 66 6643

Fixing type

back-to-back

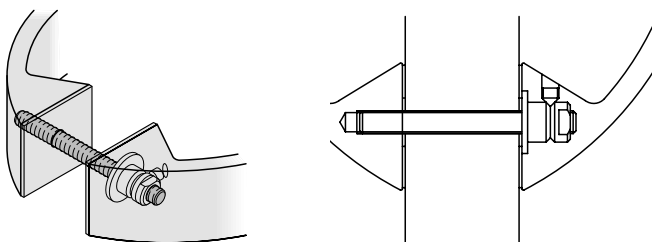

Fixing accessories

Drill hole \varnothing 13 mm
2 \times M6 threaded studs

05 0580 01208 (8–10 mm, glass door)
05 0580 03235 (35–54 mm)
05 0580 03255 (55–74 mm)
05 0580 03275 (75–94 mm)

bolt through-fixing

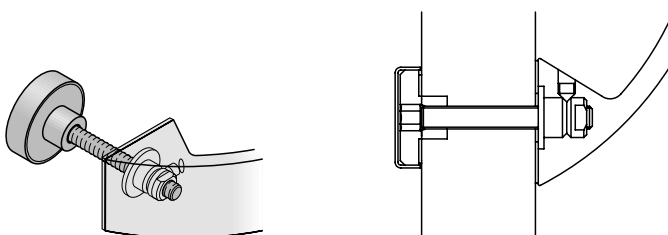

Drill hole \varnothing 13/18 mm, see page 692
2 \times M6 threaded studs
2 \times fastening nuts with cover caps

05 0580 02208 (8–10 mm, glass door)
05 0580 04235 (35–44 mm)
05 0580 04245 (45–54 mm)
05 0580 04255 (55–64 mm)
05 0580 04265 (65–74 mm)
05 0580 04275 (75–84 mm)

face fixing with threaded insert

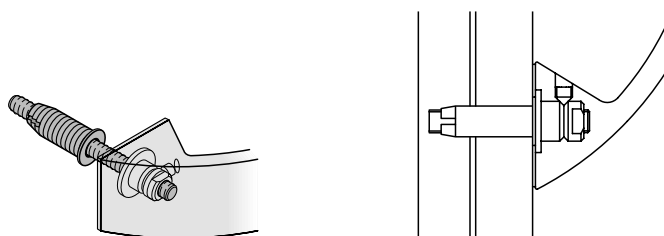

Drill hole \varnothing 12.5 mm (timber doors)
Drill hole \varnothing 13 mm (metal/PVC doors)
2 \times M6 grub screws
2 \times self-tapping threaded inserts in hardened
galvanised steel

05 0580 00435 (X: 10–30 mm, plug length 38 mm)

X = cavity dimension

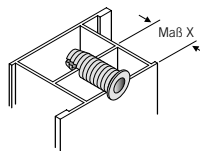

Technical information

Fixing door pulls

Door pull series

Oval ht kit
Round ht kit

66 6522, 66 6523, 66 6524, 66 6527, 61 6254

Fixing type

back-to-back

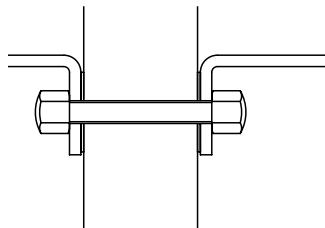
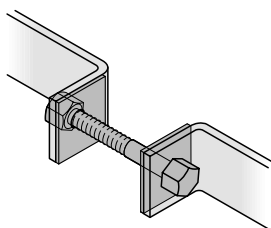

Fixing accessories

Drill hole \varnothing 13 mm
2 × M8 threaded studs
4 × stainless steel M8 domed nuts
4 × plastic washers

05 0585 03035 (35–39 mm)
05 0585 03040 (40–44 mm)
05 0585 03045 (45–49 mm)
05 0585 03050 (50–54 mm)
05 0585 03055 (55–59 mm)
05 0585 03060 (60–64 mm)
05 0585 03065 (65–69 mm)
05 0585 03070 (70–74 mm)
05 0585 03075 (75–79 mm)
05 0585 03080 (80–84 mm)

bolt through-fixing

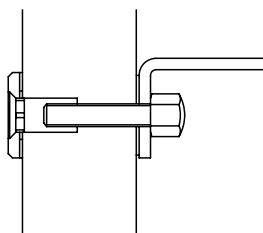
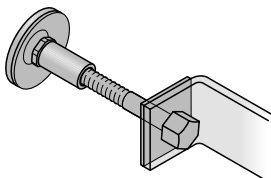

Drill hole \varnothing 13 mm
2 × M8 threaded studs
2 × stainless steel M8 domed nuts
2 × M8 cap nuts with stainless steel washers
4 × plastic washers

05 0585 02035 (35–44 mm)
05 0585 02045 (45–54 mm)
05 0585 02055 (55–64 mm)
05 0585 02065 (65–74 mm)
05 0585 02075 (75–84 mm)

face fixing with threaded insert

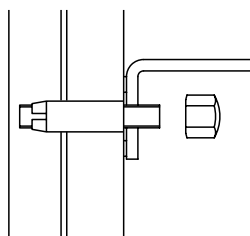
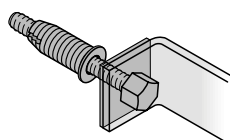

Drill hole \varnothing 12.5 mm (timber doors)
Drill hole \varnothing 13 mm (metal/PVC doors)
2 × M8 grub screws
2 × stainless steel M8 domed nuts
2 × self-tapping threaded inserts in hardened galvanised steel
2 × plastic washers

05 0585 00335 (X: 10–30 mm, plug length 38 mm)
05 0585 00336 (X: 10–41 mm, plug length 45 mm)
05 0585 00337 (X: 10–54 mm, plug length 58 mm)

X = cavity dimension

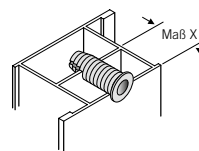

Technical information

Letter plates

Letter plates

FSB letter plates have a spring mechanism, thus also allowing them to be fitted vertically. Furthermore, FSB manufactures letter plates with custom inscriptions.

EN 13724

The European Committee for Standardization drew up the above standard in cooperation with the Deutsche Bundespost (the German federal post office), letter plate manufacturers and representatives of consumer associations. With regard to the aperture for domestic letter boxes, the standard stipulates that a test envelope 24 mm thick and in C4 format (= 229 × 324 mm) must be able to pass through without being crumpled or otherwise damaged. Model 38 3829 meets these requirements.

Installation notes

When fitting letter plates, please ensure that they are not directly exposed to driving rain.

Fixing

Place the outside flap of the letter plate on the cut-out and secure with four M4 countersunk screws (or with four self-tapping screws Ø 3.9 mm). If using the letter plate set with spacer and inner flap, first secure the door tidy with four M4 countersunk screws (or self-tapping screws Ø 3.9 mm) and then mount the outside flap as described above. Further details can be found in the installation instructions.

Letter plates

In order to provide an individual quote, we need the following information:

- Desired material (aluminium or stainless steel)
- Artwork (lettering/graphic)
- Font type/size

Besides a broad range of typefaces, we can also arrange for your artwork to be input in vectored form. Unless other fonts, sizes and styles are specified when ordering, we produce typographic engravings in 'Arial' font. We process all common image and graphics formats, i.e. pixel data such as .tiff, .jpeg or .bmp, and vector data such as .dxf, .cdr or .eps.

The data must be checked and run through a simulation before a quote can be drawn up. Please note that custom designs take longer to deliver.

Laser engravings

Engraved area:
610 × 610 mm
Flat or slightly curved

Workpiece size:
H 200 × 610 × 610 mm,
cylindrical objects up to Ø 110 mm,
max. length 360 mm

Fonts:
Height of capital letters 2.0 mm upwards

Laser engravings generally have a metallic white look (even on colour-anodised finishes) due to the aluminium-specific oxide layer. Laser engravings on stainless steel finishes are black.

Digital printing

Inscription area:
297 × 420 mm
Full bleed printing

Workpiece size:
Max. 297 × 420 mm
Workpieces must be flat, such as metal plates and signs; cylindrical objects are not possible

Fonts:
Height of capital letters 2.0 mm upwards
Four colour print, all RAL colours

FSB can process any graphics file for digital printing: pixel data such as .tiff, .jpeg or .bmp and vector data such as .dxf, .cdr or .eps.



702 Door pulls with Fingerscan

Door pulls with Fingerscan

Added value at a glance

Door pulls with Fingerscan technology can tell from your fingers whether you're authorised to enter ... or not. Biometric systems have been used in banks and high-security areas for many years. Now this proven technology is also available for your entrance door, coupled with top-notch FSB design.

Convenient access: your key is always 'to hand'. Simply pass a finger over the scanner to open the door.

Easy administration: new users, authorisations and settings can be created, changed or deleted conveniently using an app, with no need for additional programming tools, PCs or accessories.

Ergonomic: your finger finds the biometric reader almost automatically thanks to its optimal position. The door pull is precisely adapted to the proportions of your entrance door.

Versatile use: up to 150 users can be created in the app and stored there with one or more fingerprints. Ideal for private homes and small-to-medium-sized companies.

Event memory: a chronological log of 1,000 events with timestamp and date ensures that there is a record of each time the door is opened.

Protected against forgery: every fingerprint is unique! Individual changes, such as those to children's hands as they grow, for example, or minor injuries, do not present a problem either. The system is constantly learning and thus optimising its recognition performance.



Protection against loss: no more losing or forgetting keys – and it's impossible to accidentally lock yourself out. Individual reset codes can also optionally be created.

Tamper-proof: the switching relay is securely located inside. Tampering is not possible. A locking mechanism temporarily locks the system after multiple failed attempts to open the door.

Reliability: the robust design of the biometric reader ensures that fingers are reliably scanned regardless of temperature fluctuations, humidity and dirt.

Cleaning: the self-cleaning line sensor prevents latent fingerprints on the reader, so that it is impossible to copy them for nefarious purposes.

Suitable for outdoor use: the system is designed for reliable use at ambient temperatures of -20°C to $+70^{\circ}\text{C}$.

Compatibility: suitable for optional operation of motorised locks, electric openers, peripheral devices, alarm systems or garage openers, thanks to preconfigured controllers.

Data protection: data transfer is encrypted and takes place via a secure pairing process between the door pull unit on the outside and the switching relay on the inside.

Locking: in combination with an electric opener or multipoint lock, the door is fully locked/unlocked each time it is closed/opened, respectively.

Customised: manufactured according to your wishes and requirements, with bracket dimensions as well as outsize lengths.

Technical specifications

| Relay | F1000 = 1 | F2000 = 2 |
|------------------------------|---------------------------------------------------------------------------------------------------------|-----------|
| Recommended installation | Centre of scanner 1,200 mm above top edge of finished floor, connection on site by qualified specialist | |
| Input voltage | 8–24 V AC | |
| Power consumption | Max. 1 watt | |
| Temperature range of scanner | -20°C to $+70^{\circ}\text{C}$ | |
| Humidity | Max. 95% | |
| Biometric parameters | FAR* 1×10^{-6} with FRR** 3×10^{-2} | |

* FAR = False Acceptance Rate: the system recognising someone who has not been registered yet.
** FRR = False Rejection Rate: the system not recognising someone who has been registered already.

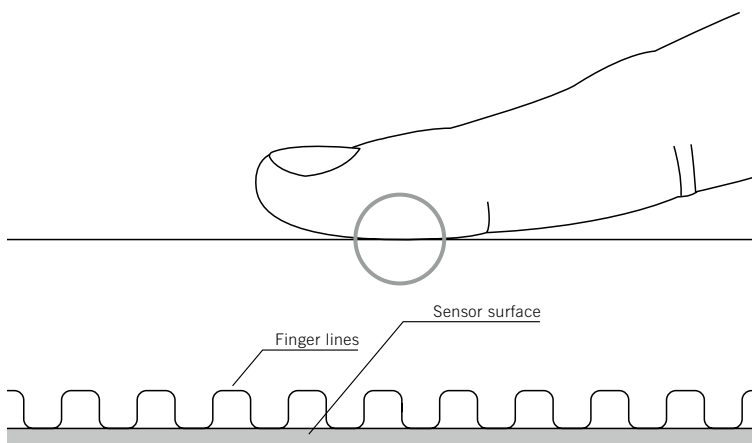

8b

Door pulls with Fingerscan

Round FSB Fingerscan

■ Aluminium
■ Stainless steel
■ Bronze

24 6607  

Grip cross-section \varnothing 35 mm

A: 300 mm – 1,500 mm with 2 brackets
B: 150 mm – 1,350 mm with 2 brackets

Multipoint brackets in outsize lengths available

Safety clearance (S) = 57 mm,
see page 690



Door pulls with Fingerscan

Round FSB Fingerscan

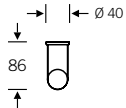
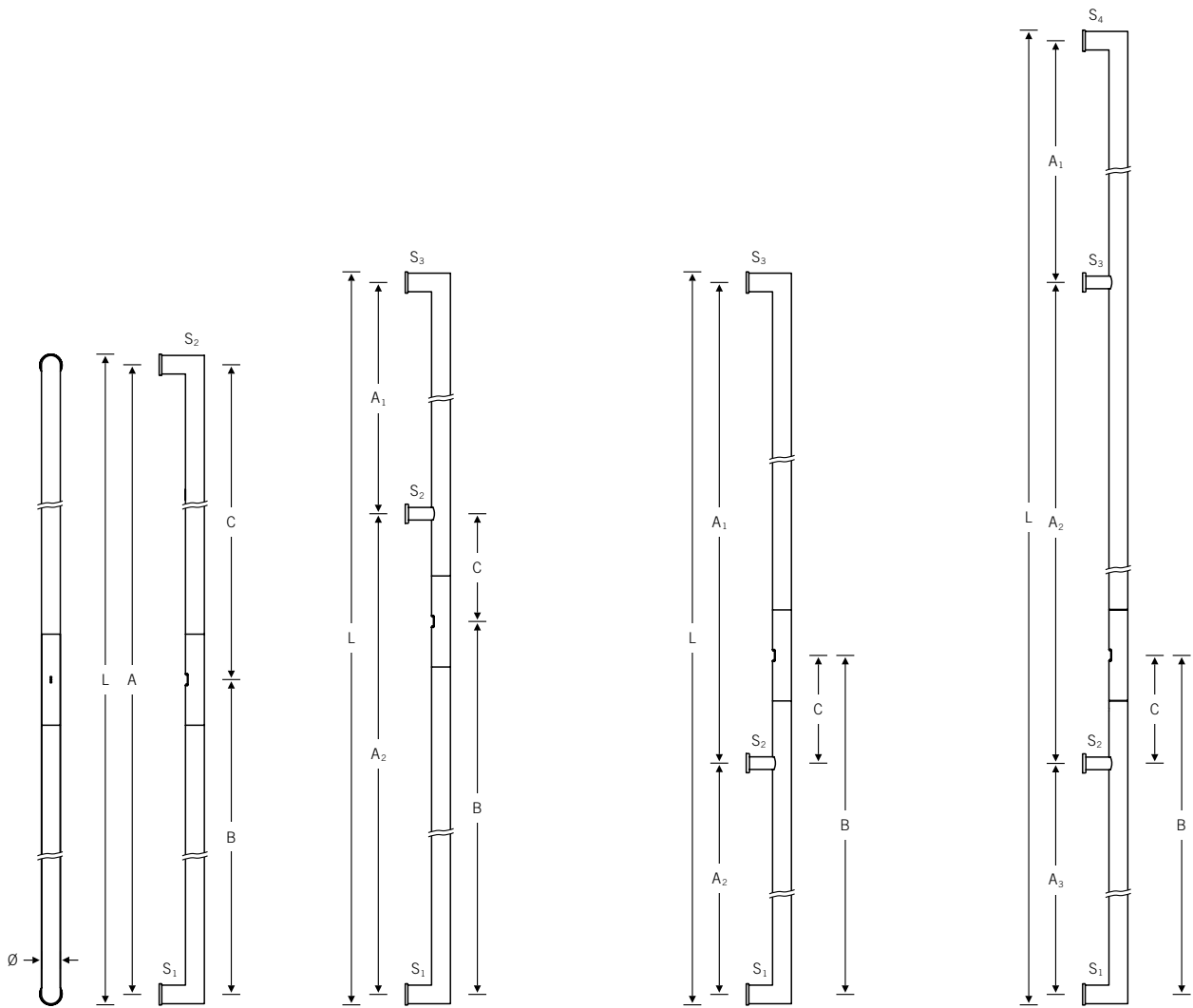

24 6607 02000
with 2 brackets

A 300–1,500 mm
C 150–1,350 mm
B 150–1,350 mm
L A + 40 mm

24 6607 03000
with 3 brackets
Reader below the middle
bracket

A₁ 100–1,200 mm
A₂ 300–1,200 mm
C 150–1,050 mm
B 150–1,050 mm
L A₁ + A₂ + 40 mm

24 6607 03100
with 3 brackets
Reader above the middle
bracket

A₁ 300–1,200 mm
A₂ 100–1,200 mm
C 150–1,050 mm
B 250–2,250 mm
L A₁ + A₂ + 40 mm

24 6607 04000
with 4 brackets

A₁ 100–1,200 mm
A₂ 300–1,200 mm
A₃ 100–1,200 mm
C 150–1,050 mm
B 250–2,250 mm
L A₁ + A₂ + A₃ + 40 mm

8b

Door pulls with Fingerscan

Round FSB Fingerscan

■ Aluminium
■ Stainless steel
■ Bronze

24 6531 ■

Grip cross-section \varnothing 35 mm

A: 300 mm – 1,200 mm with 2 brackets
B: 150 mm – 1,050 mm with 2 brackets

Multipoint brackets in outsize lengths available

Pictured: RH variant



Door pulls with Fingerscan

Round FSB Fingerscan

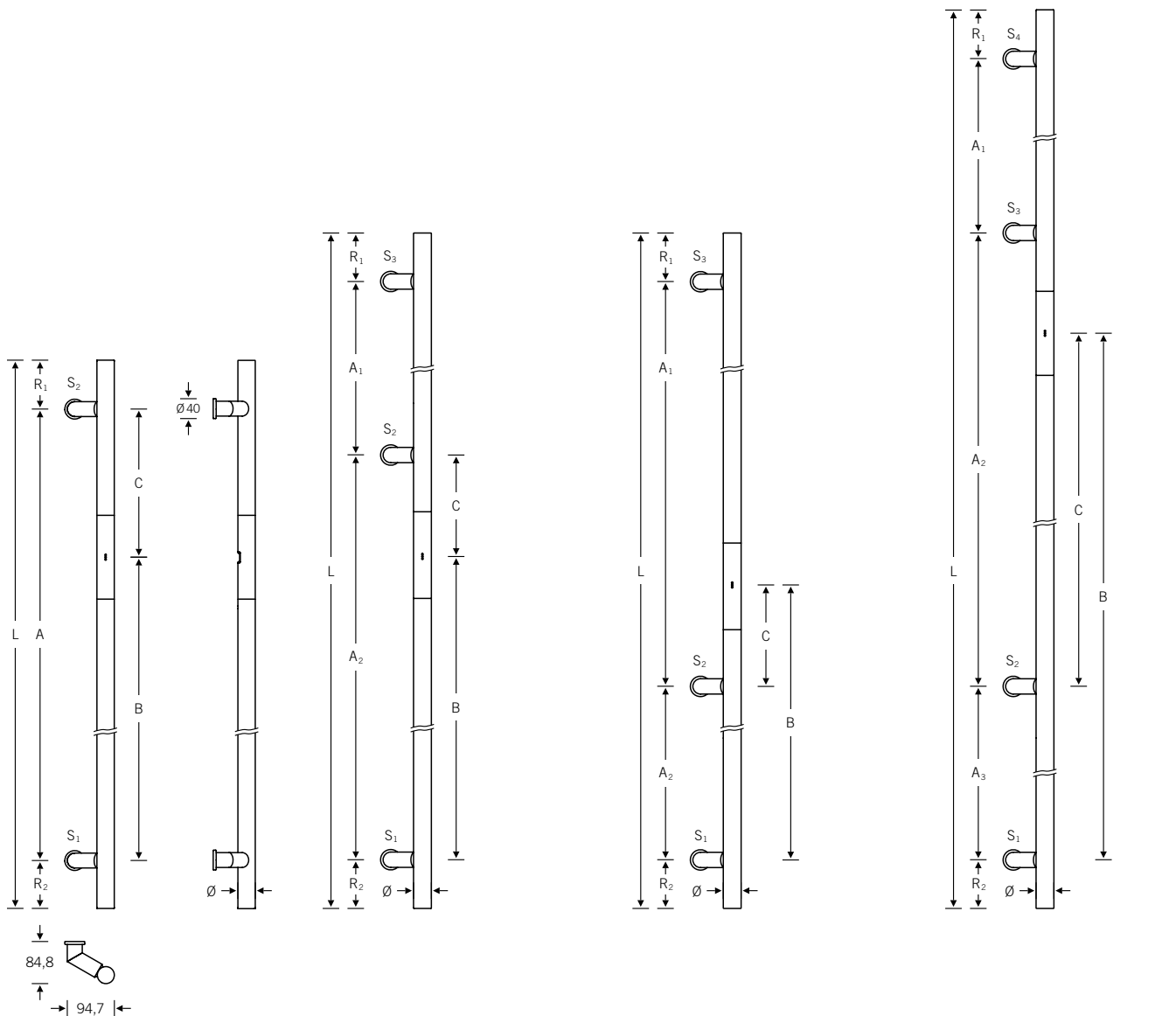

24 6531 02000 RH
24 6531 02001 LH
with 2 brackets

R_1 30–350 mm
 R_2 30–350 mm
 A 300–1,200 mm
 C 150–1,050 mm
 B 150–1,050 mm
 L $R_1 + A_1 + R_2$

24 6531 03000 RH
24 6531 03001 LH
with 3 brackets
Reader below the middle
bracket

R_1 30–350 mm
 R_2 30–350 mm
 A_1 100–1,200 mm
 A_2 300–1,200 mm
 C 150–1,050 mm
 B 150–1,050 mm
 L $R_1 + A_1 + A_2 + R_2$

24 6531 03100 RH
24 6531 03101 LH
with 3 brackets
Reader above the middle
bracket

R_1 30–350 mm
 R_2 30–350 mm
 A_1 300–1,200 mm
 A_2 100–1,200 mm
 C 150–1,050 mm
 B 250–2,250 mm
 L $R_1 + A_1 + A_2 + R_2$

24 6531 04000 RH
24 6531 04001 LH
with 4 brackets

R_1 30–350 mm
 R_2 30–350 mm
 A_1 100–1,200 mm
 A_2 300–1,200 mm
 A_3 100–1,200 mm
 C 150–1,050 mm
 B 250–2,250 mm
 L $R_1 + A_1 + A_2 + A_3 + R_2$

8b

Door pulls with Fingerscan

Round FSB Fingerscan

■ Aluminium
■ Stainless steel
■ Bronze

24 6582 ■

Grip cross-section \varnothing 35 mm

A: 300 mm – 1,200 mm with 2 brackets

B: 150 mm – 1,050 mm with 2 brackets

Multipoint brackets in outsize lengths available

Safety clearance (S) = 58 mm,
see page 690



Door pulls with Fingerscan

Round FSB Fingerscan

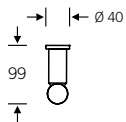
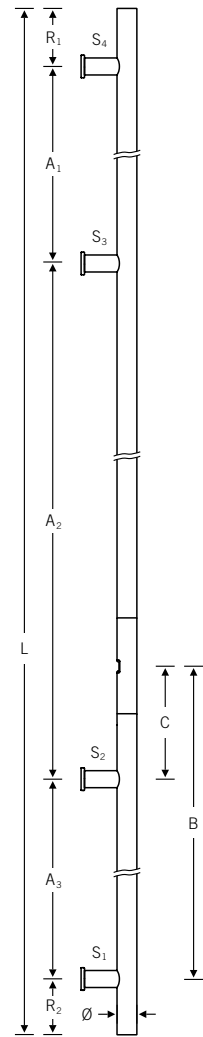
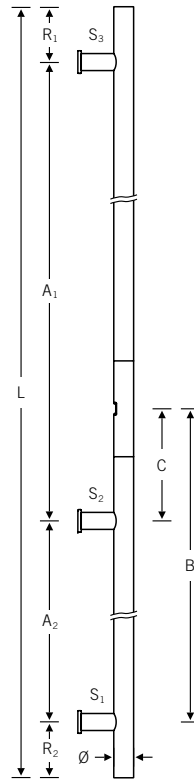
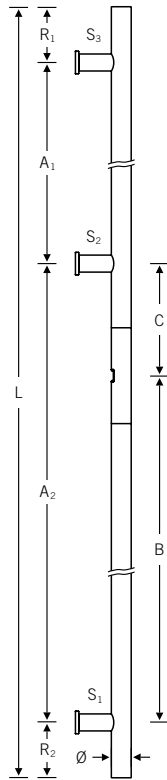
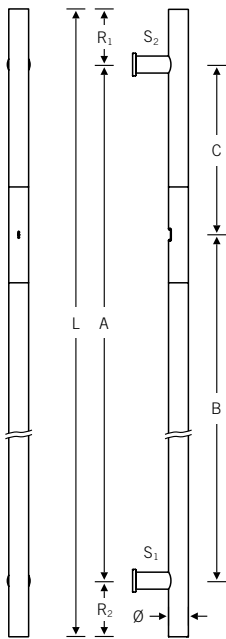

24 6582 02000
with 2 brackets

- R₁ 30–350 mm
- R₂ 30–350 mm
- A 300–1,200 mm
- C 150–1,050 mm
- B 150–1,050 mm
- L R₁ + A₁ + R₂

24 6582 03000
with 3 brackets
Reader below the middle
bracket

- R₁ 30–350 mm
- R₂ 30–350 mm
- A₁ 100–1,200 mm
- A₂ 300–1,200 mm
- C 150–1,050 mm
- B 150–1,050 mm
- L R₁ + A₁ + A₂ + R₂

24 6582 03100
with 3 brackets
Reader above the middle
bracket

- R₁ 30–350 mm
- R₂ 30–350 mm
- A₁ 300–1,200 mm
- A₂ 100–1,200 mm
- C 150–1,050 mm
- B 250–2,250 mm
- L R₁ + A₁ + A₂ + R₂

24 6582 04000
with 4 brackets

- R₁ 30–350 mm
- R₂ 30–350 mm
- A₁ 100–1,200 mm
- A₂ 300–1,200 mm
- A₃ 100–1,200 mm
- C 150–1,050 mm
- B 250–2,250 mm
- L R₁ + A₁ + A₂ + A₃ + R₂

8b



- 712 Security fittings
- 720 Backplate sets
- 737 Security roses
- 743 Technical information

Security fittings

Added value at a glance

There's safe, there's even safer – and then there's FSB. While rates are dropping in Germany, there are still increasingly more break-ins reported now than five or ten years ago. Don't leave it to chance – play it safe with our entrance door fittings! Criminal statistics indicate that doors and windows are popular means of gaining access to buildings. This is why police advice centres and insurance companies recommend adequately securing doors and windows.

FSB security fittings are listed in the KEINBRUCH manufacturer index, a security initiative of the German police.

FSB's design offering is laid out in the following pages, along with a set of technical questions for each design; all you have to do is tick the options that apply to you.

Diverse materials and finishes in aluminium, stainless steel and bronze

Modular multilayer design developed in-house offers more security

Cylinder guard made of hardened manganese steel prevents the cylinder from being pulled or knocked off

Perfect 3 mm edge radius



Certified under EN 1906 or DIN 18257

Optional oval backplate, including short backplates, available; inside backplate can be supplied as backplate and rose version

Long backplate set with security grades S2 and S4

First choose the design, then the security grade: can be combined with over 40 door handle models

Non-handed lever/knob sets with different knob designs

The lock, lock cylinder and backplate form a single unit. This makes it more difficult to unscrew, break, pull off or smash through the lock cylinder.

Listed in the KEINBRUCH manufacturer index



8c

Security fittings

Product variants

Product features of backplate sets

- Tested and certified under EN 1906 and DIN 18 257
- Security grade 2 (with and without cylinder guard)
- Security grade 4 (with cylinder guard)
- Available as standard and fire safety variant

- Burglary-resistant construction elements that put potential burglars off or considerably hold them up
- Modular multilayer design

FSB security fittings are delivered as backplate sets for the following door thicknesses as standard:

Internal doors 40–42 mm
Entrance doors 67–69 mm
Fire doors 53–57 mm

Backplate set 73 7360



Standard 73 7360
Fire safety 73 7560

- Clean design
- Angular backplate on the inside
- Centres for PC 72 and 92 mm

Short backplates



Standard 73 73..
Fire safety 73 75..

- Oval variant
- Security grade S2 available as open version and S2-ZA with cylinder guard
- Centres for PC 72 mm

Long backplates



Standard 73 73..
Fire safety 73 75..

- Oval or angular variant
- Angular variant with 3 mm edge radius
- Security grade S2 available as open version and S2-ZA with cylinder guard
- Security grade S4-ZA with cylinder guard available
- Centres for PC 72, 78, 88 and 92 mm

Product features of security roses

- Security roses for entrance doors in combination with a door pull
- Burglary-resistant construction elements that put potential burglars off or considerably hold them up
- Product solutions for flush and narrow-stile doors
- Modular multilayer design

Security roses for flush doors tested and certified



- Tested and certified under DIN 18257 ES 1 and DIN 18273 for fire doors
- Round variant available with cylinder guard (ZA) and as open version
- Square variant with cylinder guard (ZA)
- Round rose also available as flush-fitted variant

Security roses for flush doors



- Not tested and certified under DIN 18257 ES 1 and DIN 18273
- Round variant
- Available with cylinder guard (ZA) and as open version

Security roses for narrow-stile doors



- Not tested and certified under DIN 18257 ES 1 and DIN 18273
- Oval and angular variant with cylinder guard (ZA)

More burglary-resistant roses for narrow-stile doors – which are not certified under DIN 18257 or DIN 18273 – can be found on page 485:

- 17 1765 | 1766: angular and oval slide-on rose
- 17 1768 | 1769: angular adhesive rose
- 17 1729 | 1730: oval adhesive rose

Security fittings

Overview

Backplate sets

73 7360 ■
Page 720



73 7372 ■
Page 721



73 7373 ■
Page 722



73 7374 ■ ■
Page 723



73 7375 ■ ■ ■
Page 724



73 7376 ■ ■ ■
Page 725



73 7377 ■ ■ ■
Page 726



73 7378 ■ ■ ■
Page 727



73 7379 ■ ■ ■
Page 728



73 7381 ■ ■ ■
Page 729



73 7382 ■ ■ ■
Page 730



73 7383 ■ ■ ■
Page 731



73 7384 ■ ■ ■
Page 732



73 7385 ■ ■ ■
Page 733



73 7386 ■ ■ ■
Page 734



Sets for narrow-stile doors

73 7330 ■ ■
Page 735

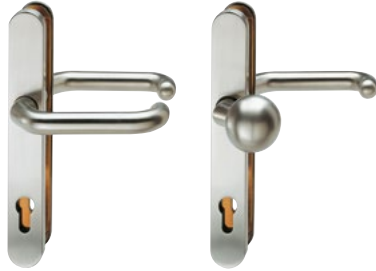

73 7331 ■ ■
Page 736



Security roses

73 3244 ■
Page 737



73 3249 ■ ■ ■
Page 737



73 7391 | 73 7392 | 73 7393 ■ ■
Page 738



73 7395 ■ ■ ■
Page 739



73 7396 ■ ■ ■
Page 741



73 7397 ■
Page 740



Security fittings

Backplate set

- Aluminium
- Stainless steel
- Bronze

73 7360



| | | | |
|-----------------------------------------------------------------------|-----------------|---------------------------------------------------------------------------------------------------------------|----------------------------------|
| Order details | Standard | <input type="checkbox"/> 73 7360 | <input type="checkbox"/> 73 7560 |
| | Fire safety | | <input type="checkbox"/> 73 7560 |
| Set type | | <input type="checkbox"/> Lever/knob set | |
| Inside hardware | | <input type="checkbox"/> Angular backplate | |
| Security grade of backplate set | | <input type="checkbox"/> S4-ZA | 8 – 15 mm |
| Set handing | | <input type="checkbox"/> Handle inside pointing right <input type="checkbox"/> Handle inside pointing left | |
| Set to match door thickness | | _____ mm | |
| Centres (C) for PC | | <input type="checkbox"/> 72 mm <input type="checkbox"/> 92 mm | |
| Square spindle | | <input type="checkbox"/> 8 mm (PC 72) | |
| Please specify cavity dimension (X) for spindle 05 0115, see page 765 | | <input type="checkbox"/> 9 mm (PC 72) | |
| | | <input type="checkbox"/> 10 mm (PC 92) | |
| Material/colour | Stainless Steel | <input type="checkbox"/> 6204 | <input type="checkbox"/> 6205 |

Order quantity: _____ sets

Supplied door handle model:
FSB 1108 (stainless steel)
Other models available upon request

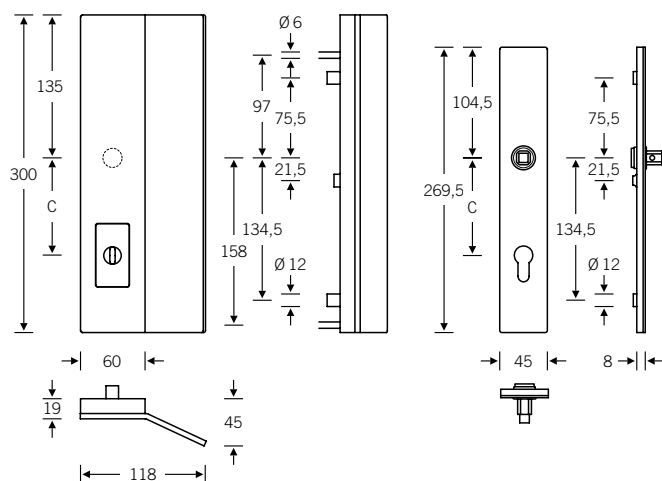

Security fittings

Backplate set

Aluminium
 Stainless steel
 Bronze

73 7372



| | | | |
|-----------------------------------|-----------------|---------------------------------------------------------------------------------------------------------------|-----------------------------------|
| Order details | Standard | <input type="checkbox"/> 73 7372 | |
| Set type | | <input type="checkbox"/> Lever/knob set | |
| Inside hardware | | <input type="checkbox"/> Backplate | |
| Security grade of backplate set | | <input type="checkbox"/> S3 pursuant to EN 1906, cylinder guard (ZA) 8 – 12 mm suitable for RC3 doors | |
| Set handing | | <input type="checkbox"/> Handle inside pointing right <input type="checkbox"/> Handle inside pointing left | |
| Set to match door thickness | 38 – 102 mm | _____ mm | |
| Centres (C) for PC | | <input type="checkbox"/> 55 mm | <input type="checkbox"/> 85 mm |
| | | <input type="checkbox"/> 70 mm | <input type="checkbox"/> 88 mm |
| | | <input type="checkbox"/> 72 mm | <input type="checkbox"/> 92 mm |
| Square spindle | | <input type="checkbox"/> 7 mm | <input type="checkbox"/> 8/8.5 mm |
| | | <input type="checkbox"/> 8 mm | <input type="checkbox"/> 8/10 mm |
| Material/colour Outside backplate | Stainless Steel | <input type="checkbox"/> 6204 | <input type="checkbox"/> 6205 |
| Material/colour Inside backplate | Aluminium | <input type="checkbox"/> 0105 | <input type="checkbox"/> 0810 |
| | Stainless Steel | <input type="checkbox"/> 6204 | |

Order quantity: _____ sets

The lever handle model can be freely selected and must be ordered separately; for possible designs, see page 324 ff.

8c

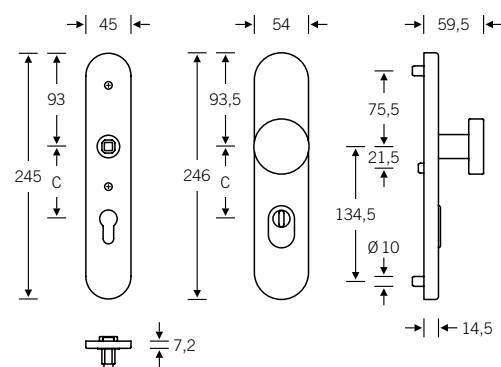

EN 1906
ÖNORM B3859
SKG

Also available as lever/lever set, see page 374

Security fittings

Backplate set

- Aluminium
- Stainless steel
- Bronze

73 7373



| | | |
|-----------------------------------|-----------------|-------------------------------------------------------------------------------------------------------------------------------------------------------------------------------------------------|
| Order details | Standard | <input type="checkbox"/> 73 7373 |
| Set type | | <input type="checkbox"/> Lever/knob set |
| Inside hardware | | <input type="checkbox"/> Backplate |
| Security grade of backplate set | | <input type="checkbox"/> S3 pursuant to EN 1906, cylinder guard (ZA) 8–12 mm suitable for RC3 doors |
| Set handing | | <input type="checkbox"/> Handle inside pointing right <input type="checkbox"/> Handle inside pointing left |
| Set to match door thickness | 38–102 mm | _____ mm |
| Centres (C) for PC | | <input type="checkbox"/> 55 mm <input type="checkbox"/> 85 mm <input type="checkbox"/> 70 mm <input type="checkbox"/> 88 mm <input type="checkbox"/> 72 mm <input type="checkbox"/> 92 mm |
| Square spindle | | <input type="checkbox"/> 7 mm <input type="checkbox"/> 8/8.5 mm <input type="checkbox"/> 8 mm <input type="checkbox"/> 8/10 mm |
| Material/colour Outside backplate | Stainless Steel | <input type="checkbox"/> 6204 |
| Material/colour Inside backplate | Aluminium | <input type="checkbox"/> 0105 |
| | Stainless Steel | <input type="checkbox"/> 6204 <input type="checkbox"/> 0810 |

Order quantity: _____ sets

The lever handle model can be freely selected and must be ordered separately; for possible designs, see page 324 ff.

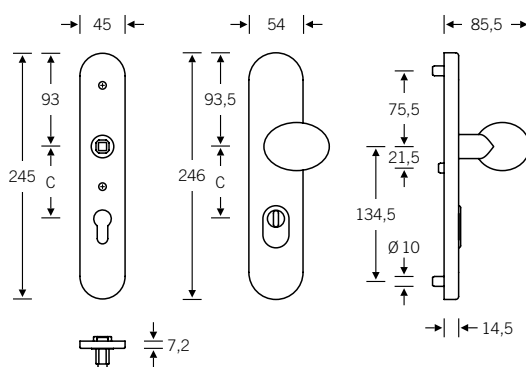

EN 1906
ÖNORM B3859
SKG

Also available as lever/lever set, see page 374

Security fittings

Short backplate set

Aluminium
 Stainless steel
 Bronze

73 7374



| | | | |
|---------------------------------|-----------------|-------------------------------------------------------|-------------------------------------------|
| Order details | Standard | <input type="checkbox"/> 73 7374 | |
| | Fire safety | <input type="checkbox"/> 73 7574 | |
| Set type | | <input type="checkbox"/> Lever/knob set | <input type="checkbox"/> Lever/lever set* |
| Inside hardware | | <input type="checkbox"/> Backplate | <input type="checkbox"/> Roses |
| Security grade of backplate set | | <input type="checkbox"/> S2 | 11 mm |
| | | <input type="checkbox"/> S2 | 15 mm |
| | | <input type="checkbox"/> S2-ZA | 8–15 mm |
| Security grade of rose set | | <input type="checkbox"/> S2-ZA | 8–15 mm |
| Set handing | | <input type="checkbox"/> Handle inside pointing right | |
| | | <input type="checkbox"/> Handle inside pointing left | |
| Set to match door thickness | | _____ mm | |
| Centres (C) for PC | | <input type="checkbox"/> 72 mm | |
| Square spindle | | <input type="checkbox"/> 8 mm | |
| | | <input type="checkbox"/> 9 mm | |
| Material/colour | Aluminium | <input type="checkbox"/> 0105 | <input type="checkbox"/> _____ |
| | Alu. + colour | <input type="checkbox"/> White | <input type="checkbox"/> _____ |
| | Stainless Steel | <input type="checkbox"/> 6204 | <input type="checkbox"/> 6205 |

Order quantity: _____ sets

Supplied door handle model:
 FSB 1107 (aluminium, aluminium + colour, stainless steel)
 Other models available upon request

8c

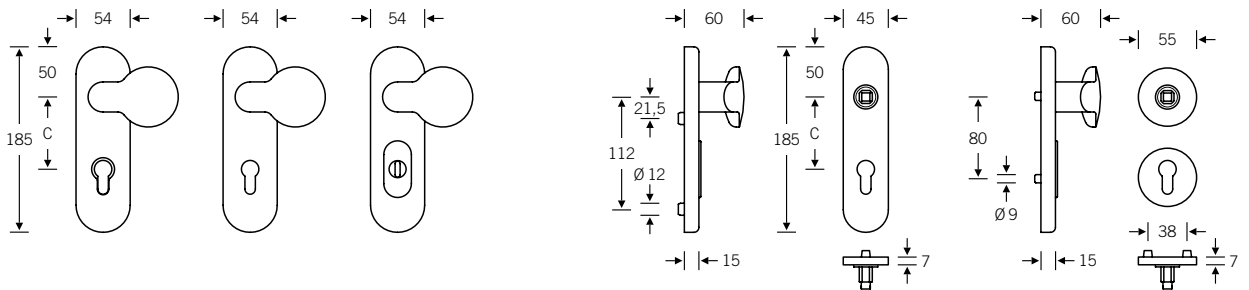

* S2-ZA only

With S2 (open version), the cylinder should not protrude more than 3 mm

Security fittings

Long backplate set

- Aluminium
- Stainless steel
- Bronze

73 7375



| | | | |
|---------------------------------|------------------------------------------------------------------------------------------------------------|-------------------------------------------------------|----------------------------------|
| Order details | Standard Fire safety | <input type="checkbox"/> 73 7375 | <input type="checkbox"/> 73 7575 |
| Set type | | <input type="checkbox"/> Lever/knob set | |
| Inside hardware | | <input type="checkbox"/> Backplate | <input type="checkbox"/> Roses |
| Security grade of backplate set | | <input type="checkbox"/> S2 | 11 mm |
| | | <input type="checkbox"/> S2 | 15 mm |
| | | <input type="checkbox"/> S2-ZA | 8–15 mm |
| | | <input type="checkbox"/> S4-ZA | 8–15 mm |
| Security grade of rose set | | <input type="checkbox"/> S2-ZA | 8–15 mm |
| Set handing | | <input type="checkbox"/> Handle inside pointing right | |
| | | <input type="checkbox"/> Handle inside pointing left | |
| Set to match door thickness | | _____ mm | |
| Centres(C) for PC | <input type="checkbox"/> 72 mm <input type="checkbox"/> 78 mm, CH-RC* <input type="checkbox"/> 72 mm | <input type="checkbox"/> 88* mm | <input type="checkbox"/> 92 mm |
| Square spindle | <input type="checkbox"/> 8 mm <input type="checkbox"/> 9 mm | <input type="checkbox"/> 8.5* mm | <input type="checkbox"/> 10 mm |
| Material/colour | Aluminium | <input type="checkbox"/> 0105 | <input type="checkbox"/> _____ |
| | Alu. + colour | <input type="checkbox"/> White | <input type="checkbox"/> _____ |
| | Stainless Steel | <input type="checkbox"/> 6204 | <input type="checkbox"/> 6205 |
| | Bronze | <input type="checkbox"/> 7615 | <input type="checkbox"/> 7625 |

Order quantity: _____ sets

Supplied door handle model:
FSB 1107 (aluminium, aluminium + colour, stainless steel)
FSB 1023 (bronze)
Other models available upon request

X: 85 mm (aluminium, aluminium + colour)
80 mm (stainless steel, bronze)

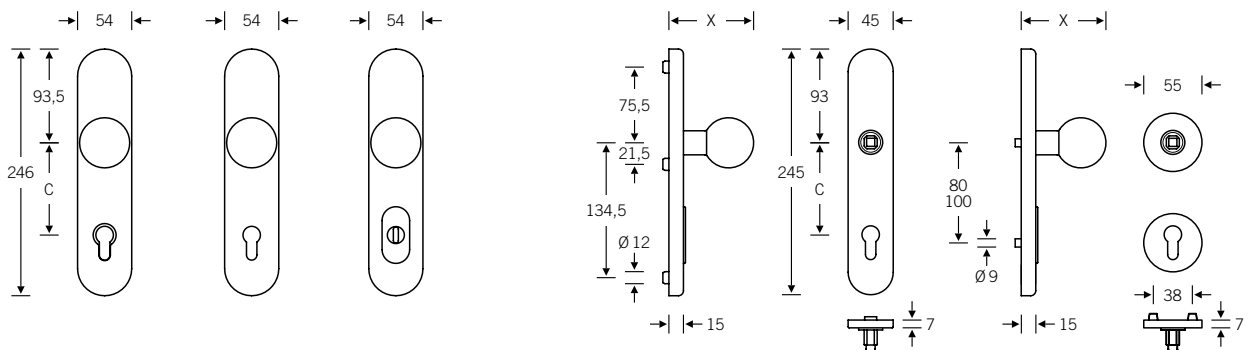

* S2-ZA only

With S2 (open version), the cylinder should not protrude more than 3 mm

Security fittings

Long backplate set

Aluminium
 Stainless steel
 Bronze

73 7376



| | | |
|---------------------------------|-------------------------------------------------------|----------------------------------|
| Order details | Standard | <input type="checkbox"/> 73 7376 |
| | Fire safety | <input type="checkbox"/> 73 7576 |
| Set type | <input type="checkbox"/> Lever/knob set | |
| Inside hardware | <input type="checkbox"/> Backplate | <input type="checkbox"/> Roses |
| Security grade of backplate set | <input type="checkbox"/> S2 | 11 mm |
| | <input type="checkbox"/> S2 | 15 mm |
| | <input type="checkbox"/> S2-ZA | 8–15 mm |
| | <input type="checkbox"/> S4-ZA | 8–15 mm |
| Security grade of rose set | <input type="checkbox"/> S2-ZA | 8–15 mm |
| Set handing | <input type="checkbox"/> Handle inside pointing right | |
| | <input type="checkbox"/> Handle inside pointing left | |
| Set to match door thickness | _____ mm | |
| Centres (C) for PC | <input type="checkbox"/> 72 mm | <input type="checkbox"/> 88* mm |
| | <input type="checkbox"/> 78 mm, CH-RC* | <input type="checkbox"/> 92 mm |
| | <input type="checkbox"/> 72 mm | |
| Square spindle | <input type="checkbox"/> 8 mm | <input type="checkbox"/> 8.5* mm |
| | <input type="checkbox"/> 9 mm | <input type="checkbox"/> 10 mm |
| Material/colour | Aluminium | <input type="checkbox"/> 0105 |
| | Alu. + colour | <input type="checkbox"/> White |
| | Stainless Steel | <input type="checkbox"/> 6204 |
| | Bronze | <input type="checkbox"/> 6205 |
| | | <input type="checkbox"/> 7615 |
| | | <input type="checkbox"/> 7625 |

Order quantity: _____ sets

Supplied door handle model:
 FSB 1107 (aluminium, aluminium + colour, stainless steel)
 FSB 1023 (bronze)
 Other models available upon request

8c

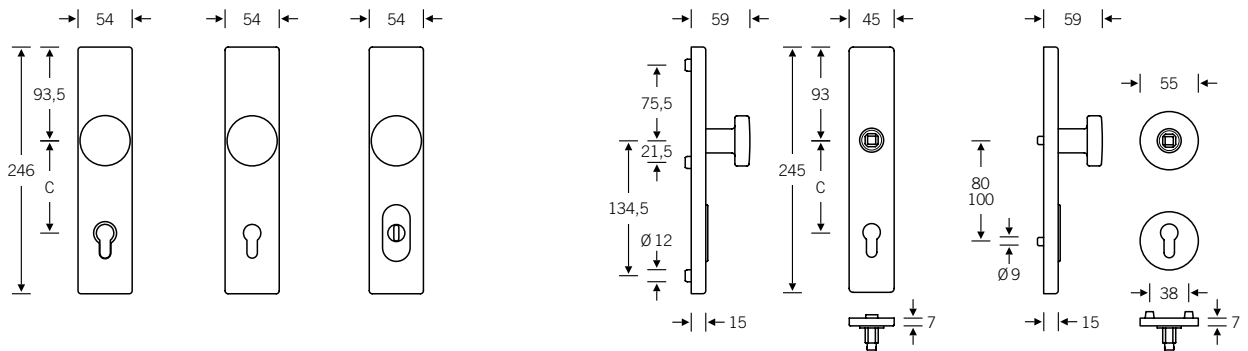

* S2-ZA only

With S2 (open version), the cylinder should not protrude more than 3 mm

Security fittings

Short backplate set

Aluminium
 Stainless steel
 Bronze

73 7377



| | | |
|---------------------------------|--------------------------------|---------------------------------------------------------------------------------------------------------------|
| Order details | Standard | <input type="checkbox"/> 73 7377 |
| | Fire safety | <input type="checkbox"/> 73 7577 |
| Set type | | <input type="checkbox"/> Lever/knob set |
| Inside hardware | | <input type="checkbox"/> Backplate <input type="checkbox"/> Roses |
| Security grade of backplate set | <input type="checkbox"/> S2 | 11 mm |
| | <input type="checkbox"/> S2 | 15 mm |
| | <input type="checkbox"/> S2-ZA | 8–15 mm |
| Security grade of rose set | <input type="checkbox"/> S2-ZA | 8–15 mm |
| Set handing | | <input type="checkbox"/> Handle inside pointing right <input type="checkbox"/> Handle inside pointing left |
| Set to match door thickness | | _____ mm |
| Centres (C) for PC | | <input type="checkbox"/> 72 mm |
| Square spindle | | <input type="checkbox"/> 8 mm <input type="checkbox"/> 9 mm |
| Material/colour | Aluminium | <input type="checkbox"/> 0105 <input type="checkbox"/> _____ |
| | Alu. + colour | <input type="checkbox"/> White <input type="checkbox"/> _____ |
| | Stainless Steel | <input type="checkbox"/> 6204 <input type="checkbox"/> 6205 |

Order quantity: _____ sets

Supplied door handle model:
FSB 1107 (aluminium, aluminium + colour, stainless steel)
Other models available upon request

X: 85 mm (aluminium, aluminium + colour)
80 mm (stainless steel)

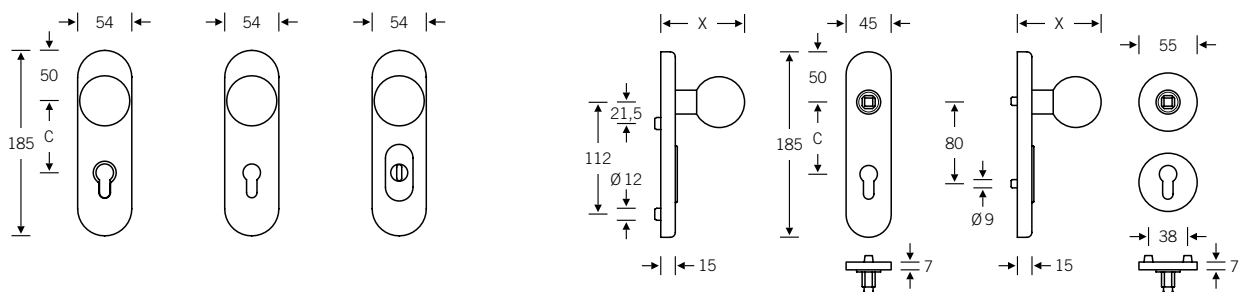

With S2 (open version), the cylinder should not protrude more than 3 mm

Security fittings

Long backplate set

Aluminium
 Stainless steel
 Bronze

73 7378



| | | |
|---------------------------------|---------------------------------------------------------------------------------------------------------------|-----------------------------------------------------------------|
| Order details | Standard | <input type="checkbox"/> 73 7378 |
| | Fire safety | <input type="checkbox"/> 73 7578 |
| Set type | <input type="checkbox"/> Lever/knob set | |
| Inside hardware | <input type="checkbox"/> Backplate | <input type="checkbox"/> Roses |
| Security grade of backplate set | <input type="checkbox"/> S2 | 11 mm |
| | <input type="checkbox"/> S2 | 15 mm |
| | <input type="checkbox"/> S2-ZA | 8–15 mm |
| | <input type="checkbox"/> S4-ZA | 8–15 mm |
| Security grade of rose set | <input type="checkbox"/> S2-ZA | 8–15 mm |
| Set handing | <input type="checkbox"/> Handle inside pointing right <input type="checkbox"/> Handle inside pointing left | |
| Set to match door thickness | _____ mm | |
| Centres (C) for PC | <input type="checkbox"/> 72 mm <input type="checkbox"/> 78 mm, CH-RC* <input type="checkbox"/> 72 mm | <input type="checkbox"/> 88*mm <input type="checkbox"/> 92 mm |
| Square spindle | <input type="checkbox"/> 8 mm <input type="checkbox"/> 9 mm | <input type="checkbox"/> 8.5* mm <input type="checkbox"/> 10 mm |
| Material/colour | Aluminium | <input type="checkbox"/> 0105 <input type="checkbox"/> _____ |
| | Alu. + colour | <input type="checkbox"/> White <input type="checkbox"/> _____ |
| | Stainless Steel | <input type="checkbox"/> 6204 <input type="checkbox"/> 6205 |
| | Bronze | <input type="checkbox"/> 7615 <input type="checkbox"/> 7625 |

Order quantity: _____ sets

Supplied door handle model:
 FSB 1107 (aluminium, aluminium + colour, stainless steel)
 FSB 1023 (bronze)
 Other models available upon request

8c

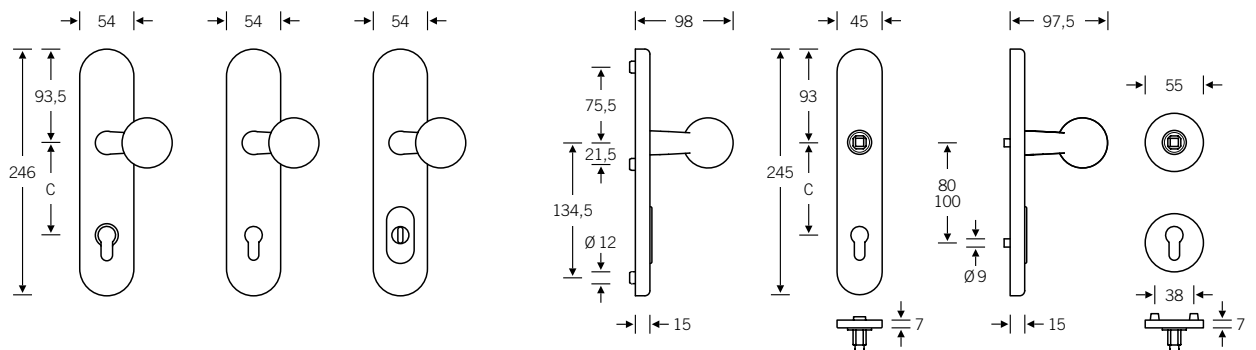

* S2-ZA only

With S2 (open version), the cylinder should not protrude more than 3 mm

Security fittings

Long backplate set

Aluminium
 Stainless steel
 Bronze

73 7379



| | | |
|---------------------------------|-------------------------------------------------------|----------------------------------|
| Order details | Standard | <input type="checkbox"/> 73 7379 |
| | Fire safety | <input type="checkbox"/> 73 7579 |
| Set type | <input type="checkbox"/> Lever/knob set | |
| Inside hardware | <input type="checkbox"/> Backplate | <input type="checkbox"/> Roses |
| Security grade of backplate set | <input type="checkbox"/> S2 | 11 mm |
| | <input type="checkbox"/> S2 | 15 mm |
| | <input type="checkbox"/> S2-ZA | 8–15 mm |
| | <input type="checkbox"/> S4-ZA | 8–15 mm |
| Security grade of rose set | <input type="checkbox"/> S2-ZA | 8–15 mm |
| Set handing | <input type="checkbox"/> Handle inside pointing right | |
| | <input type="checkbox"/> Handle inside pointing left | |
| Set to match door thickness | _____ mm | |
| Centres (C) for PC | <input type="checkbox"/> 72 mm | <input type="checkbox"/> 88* mm |
| | <input type="checkbox"/> 78 mm, CH-RC* | <input type="checkbox"/> 92 mm |
| | <input type="checkbox"/> 72 mm | |
| Square spindle | <input type="checkbox"/> 8 mm | <input type="checkbox"/> 8.5* mm |
| | <input type="checkbox"/> 9 mm | <input type="checkbox"/> 10 mm |
| Material/colour | Aluminium | <input type="checkbox"/> 0105 |
| | Alu. + colour | <input type="checkbox"/> White |
| | Stainless Steel | <input type="checkbox"/> 6204 |
| | Bronze | <input type="checkbox"/> 6205 |
| | | <input type="checkbox"/> 7615 |
| | | <input type="checkbox"/> 7625 |

Order quantity: _____ sets

Supplied door handle model:
 FSB 1107 (aluminium, aluminium + colour, stainless steel)
 FSB 1023 (bronze)
 Other models available upon request

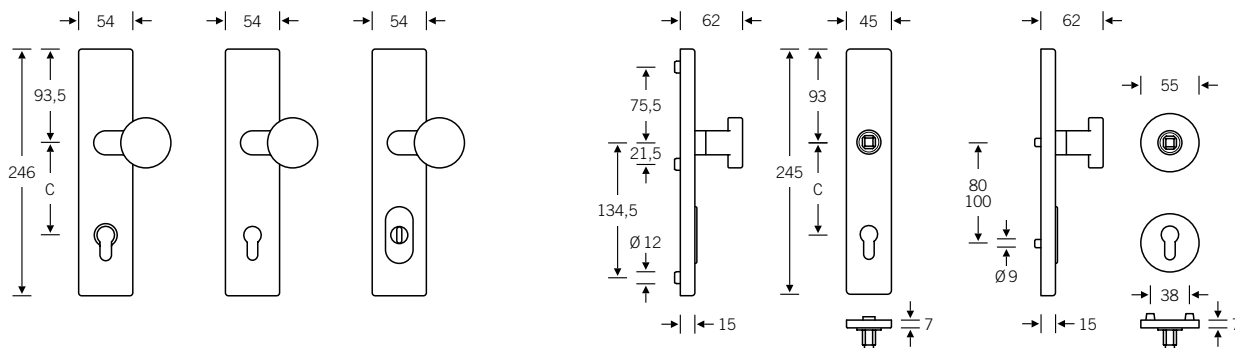

* S2-ZA only

With S2 (open version), the cylinder should not protrude more than 3 mm

Security fittings

Long backplate set

- Aluminium
- Stainless steel
- Bronze

73 7381 ■ ■



| | | | |
|---------------------------------|-------------------------------------------|--------------------------------------------------------------------|-------------------------------------------|
| Order details | Standard | <input type="checkbox"/> 73 7381 | |
| | Fire safety | <input checked="" type="checkbox"/> 73 7581 (stainless steel only) | |
| Set type | | <input type="checkbox"/> Lever/knob set | <input type="checkbox"/> Lever/lever set* |
| Inside hardware | | <input type="checkbox"/> Backplate | <input type="checkbox"/> Roses |
| Security grade of backplate set | | <input type="checkbox"/> S2 | 11 mm |
| | | <input type="checkbox"/> S2 | 15 mm |
| | | <input type="checkbox"/> S2-ZA | 8 – 15 mm |
| | | <input type="checkbox"/> S4-ZA | 8 – 15 mm |
| Security grade of rose set | | <input type="checkbox"/> S2-ZA | 8 – 15 mm |
| Set handing | | <input type="checkbox"/> Handle inside pointing right | |
| | | <input type="checkbox"/> Handle inside pointing left | |
| Set to match door thickness | | _____ mm | |
| Centres (C) for PC | <input type="checkbox"/> 72 mm | <input type="checkbox"/> 88* mm | <input type="checkbox"/> 92 mm |
| | <input type="checkbox"/> 78 mm, CH-RC* | | |
| | <input checked="" type="checkbox"/> 72 mm | | |
| Square spindle | <input type="checkbox"/> 8 mm | <input type="checkbox"/> 8.5* mm | <input type="checkbox"/> 10 mm |
| | <input checked="" type="checkbox"/> 9 mm | | |
| Material/colour | Aluminium | <input type="checkbox"/> 0105 | <input type="checkbox"/> _____ |
| | Alu. + colour | <input type="checkbox"/> White | <input type="checkbox"/> _____ |
| | Stainless Steel | <input type="checkbox"/> 6204 | <input type="checkbox"/> 6205 |

Order quantity: _____ sets

Supplied door handle model:
FSB 1107 (aluminium, aluminium + colour, stainless steel)
Other models available upon request

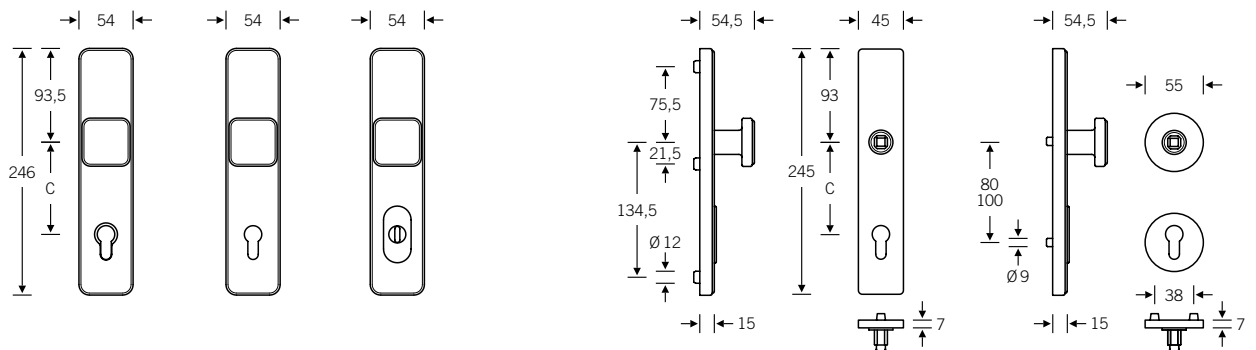

* S2-ZA only

With S2 (open version), the cylinder should not protrude more than 3 mm

Security fittings

Long backplate set

- Aluminium
- Stainless steel
- Bronze

73 7382



| | | |
|---------------------------------|--------------------------------------------------------------------------------------------------------------------------------|----------------------------------------------------------------------------------------------------------------------------------------------------------------------------------------------|
| Order details | Standard Fire safety | <input type="checkbox"/> 73 7382 <input type="checkbox"/> 73 7582 (stainless steel only) |
| Set type | | <input type="checkbox"/> Lever/knob set <input type="checkbox"/> Lever/lever set* |
| Inside hardware | | <input type="checkbox"/> Backplate <input type="checkbox"/> Roses |
| Security grade of backplate set | <input type="checkbox"/> S2 <input type="checkbox"/> S2 <input type="checkbox"/> S2-ZA <input type="checkbox"/> S4-ZA | 11 mm 15 mm 8–15 mm 8–15 mm |
| Security grade of rose set | <input type="checkbox"/> S2-ZA | 8–15 mm |
| Set handing | | <input type="checkbox"/> Handle inside pointing right <input type="checkbox"/> Handle inside pointing left |
| Set to match door thickness | | _____ mm |
| Centres (C) for PC | <input type="checkbox"/> 72 mm <input type="checkbox"/> 78 mm, CH-RC* <input type="checkbox"/> 72 mm | <input type="checkbox"/> 88* mm <input type="checkbox"/> 92 mm |
| Square spindle | <input type="checkbox"/> 8 mm <input type="checkbox"/> 9 mm | <input type="checkbox"/> 8.5* mm <input type="checkbox"/> 10 mm |
| Material/colour | Aluminium Alu. + colour Stainless Steel | <input type="checkbox"/> 0105 <input type="checkbox"/> _____ <input type="checkbox"/> White <input type="checkbox"/> _____ <input type="checkbox"/> 6204 <input type="checkbox"/> 6205 |

Order quantity: _____ sets

Supplied door handle model:
FSB 1107 (aluminium, aluminium + colour, stainless steel)
Other models available upon request

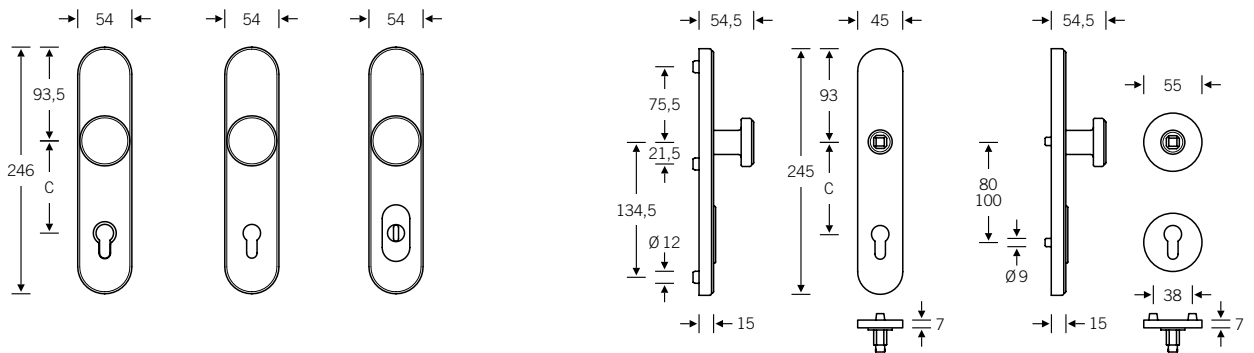

* S2-ZA only



Security fittings

Long backplate set

- Aluminium
- Stainless steel
- Bronze

73 7383 ■ ■



| | | | |
|---------------------------------|----------------------------------------|---------------------------------------------------------|-------------------------------------------|
| Order details | Standard | <input type="checkbox"/> 73 7383 | |
| | Fire safety | <input type="checkbox"/> 73 7583 (stainless steel only) | |
| Set type | | <input type="checkbox"/> Lever/knob set | <input type="checkbox"/> Lever/lever set* |
| Inside hardware | | <input type="checkbox"/> Backplate | <input type="checkbox"/> Roses |
| Security grade of backplate set | | <input type="checkbox"/> S2 | 11 mm |
| | | <input type="checkbox"/> S2 | 15 mm |
| | | <input type="checkbox"/> S2-ZA | 8 – 15 mm |
| | | <input type="checkbox"/> S4-ZA | 8 – 15 mm |
| Security grade of rose set | | <input type="checkbox"/> S2-ZA | 8 – 15 mm |
| Set handing | | <input type="checkbox"/> Handle inside pointing right | |
| | | <input type="checkbox"/> Handle inside pointing left | |
| Set to match door thickness | | _____ mm | |
| Centres (C) for PC | <input type="checkbox"/> 72 mm | <input type="checkbox"/> 88* mm | <input type="checkbox"/> 92 mm |
| | <input type="checkbox"/> 78 mm, CH-RC* | | |
| | <input type="checkbox"/> 72 mm | | |
| Square spindle | <input type="checkbox"/> 8 mm | <input type="checkbox"/> 8.5* mm | <input type="checkbox"/> 10 mm |
| | <input type="checkbox"/> 9 mm | | |
| Material/colour | Aluminium | <input type="checkbox"/> 0105 | <input type="checkbox"/> _____ |
| | Alu. + colour | <input type="checkbox"/> White | <input type="checkbox"/> _____ |
| | Stainless Steel | <input type="checkbox"/> 6204 | <input type="checkbox"/> 6205 |

Order quantity: _____ sets

Supplied door handle model:
FSB 1107 (aluminium, aluminium + colour, stainless steel)
Other models available upon request

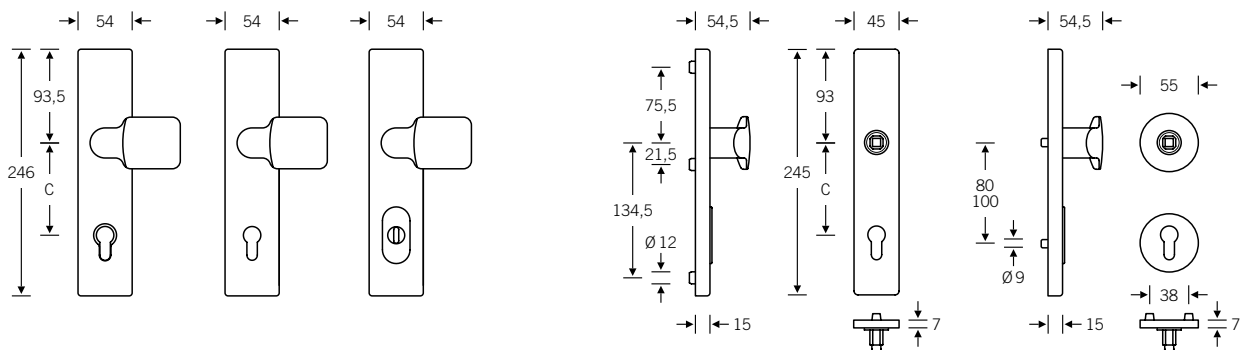

8c



* S2-ZA only

Security fittings

Long backplate set

- Aluminium
- Stainless steel
- Bronze

73 7384



| | | | |
|---------------------------------|------------------------------------------------------------------------------------------------------------------------------|--------------------------------------------------------------------------------------------------|---------------------------------------------------------------------------------------------------|
| Order details | Standard Fire safety | <input type="checkbox"/> 73 7384 <input checked="" type="checkbox"/> 73 7584 | |
| Set type | | <input type="checkbox"/> Lever/knob set | <input type="checkbox"/> Lever/lever set* |
| Inside hardware | | <input type="checkbox"/> Backplate | <input type="checkbox"/> Roses |
| Security grade of backplate set | | <input type="checkbox"/> S2 | 11 mm |
| | | <input type="checkbox"/> S2 | 15 mm |
| | | <input type="checkbox"/> S2-ZA | 8 – 15 mm |
| | | <input type="checkbox"/> S4-ZA | 8 – 15 mm |
| Security grade of rose set | | <input type="checkbox"/> S2-ZA | 8 – 15 mm |
| Set handing | | <input type="checkbox"/> Handle inside pointing right | <input type="checkbox"/> Handle inside pointing left |
| Set to match door thickness | | _____ mm | |
| Centres (C) for PC | <input type="checkbox"/> 72 mm <input type="checkbox"/> 78 mm, CH-RC* <input checked="" type="checkbox"/> 72 mm | <input type="checkbox"/> 88* mm | <input type="checkbox"/> 92 mm <input checked="" type="checkbox"/> 92* mm |
| Square spindle | <input type="checkbox"/> 8 mm <input checked="" type="checkbox"/> 9 mm | <input type="checkbox"/> 8.5* mm | <input type="checkbox"/> 10 mm |
| Material/colour | Aluminium Alu. + colour Stainless Steel | <input type="checkbox"/> 0105 <input type="checkbox"/> White <input type="checkbox"/> 6204 | <input type="checkbox"/> _____ <input type="checkbox"/> _____ <input type="checkbox"/> 6205 |

Order quantity: _____ sets

Supplied door handle model:
FSB 1107 (aluminium, aluminium + colour, stainless steel)
Other models available upon request

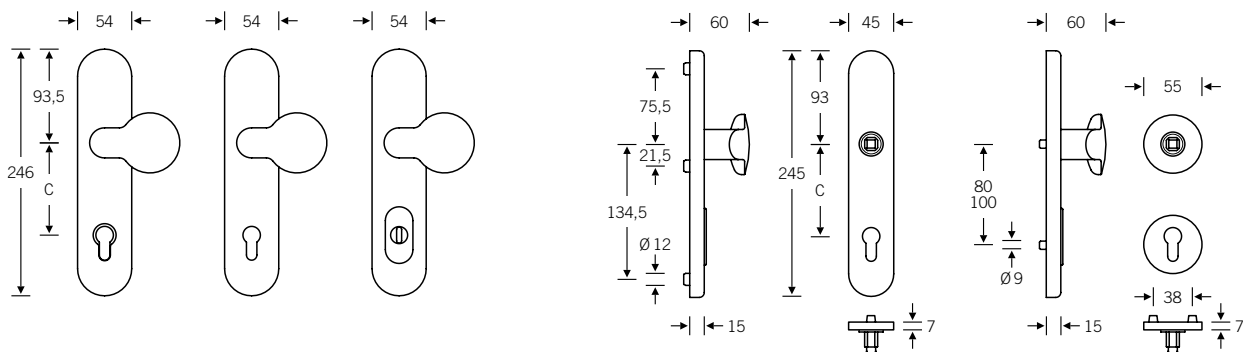

* S2-ZA only



Security fittings

Long backplate set

- Aluminium
- Stainless steel
- Bronze

73 7385 ■ ■



| | | | |
|---------------------------------|----------------------------------------|---------------------------------------------------------|-------------------------------------------|
| Order details | Standard | <input type="checkbox"/> 73 7385 | |
| | Fire safety | <input type="checkbox"/> 73 7585 (stainless steel only) | |
| Set type | | <input type="checkbox"/> Lever/knob set | <input type="checkbox"/> Lever/lever set* |
| Inside hardware | | <input type="checkbox"/> Backplate | <input type="checkbox"/> Roses |
| Security grade of backplate set | | <input type="checkbox"/> S2 | 11 mm |
| | | <input type="checkbox"/> S2 | 15 mm |
| | | <input type="checkbox"/> S2-ZA | 8 – 15 mm |
| | | <input type="checkbox"/> S4-ZA | 8 – 15 mm |
| Security grade of rose set | | <input type="checkbox"/> S2-ZA | 8 – 15 mm |
| Set handing | | <input type="checkbox"/> Handle inside pointing right | |
| | | <input type="checkbox"/> Handle inside pointing left | |
| Set to match door thickness | | _____ mm | |
| Centres (C) for PC | <input type="checkbox"/> 72 mm | <input type="checkbox"/> 88* mm | <input type="checkbox"/> 92 mm |
| | <input type="checkbox"/> 78 mm, CH-RC* | | |
| | <input type="checkbox"/> 72 mm | | |
| Square spindle | <input type="checkbox"/> 8 mm | <input type="checkbox"/> 8.5* mm | <input type="checkbox"/> 10 mm |
| | <input type="checkbox"/> 9 mm | | |
| Material/colour | Aluminium | <input type="checkbox"/> 0105 | <input type="checkbox"/> _____ |
| | Alu. + colour | <input type="checkbox"/> White | <input type="checkbox"/> _____ |
| | Stainless Steel | <input type="checkbox"/> 6204 | <input type="checkbox"/> 6205 |

Order quantity: _____ sets

Supplied door handle model:
FSB 1107 (aluminium, aluminium + colour, stainless steel)
Other models available upon request

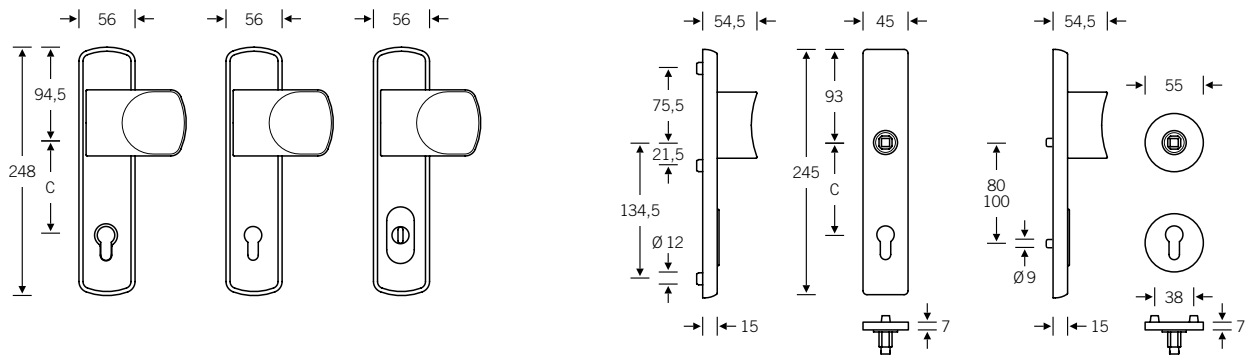

8c



* S2-ZA only

Security fittings

Long backplate set

- Aluminium
- Stainless steel
- Bronze

73 7386



| | | | |
|---------------------------------|-------------------------------------------------------------------------------------------------------------------|--------------------------------------------------------------------------------------------------|---------------------------------------------------------------------------------------------------|
| Order details | Standard Fire safety | <input type="checkbox"/> 73 7386 | <input type="checkbox"/> 73 7586 (stainless steel only) |
| Set type | | <input type="checkbox"/> Lever/knob set | <input type="checkbox"/> Lever/lever set* |
| Inside hardware | | <input type="checkbox"/> Backplate | <input type="checkbox"/> Roses |
| Security grade of backplate set | | <input type="checkbox"/> S2 | 11 mm |
| | | <input type="checkbox"/> S2 | 15 mm |
| | | <input type="checkbox"/> S2-ZA | 8 – 15 mm |
| | | <input type="checkbox"/> S4-ZA | 8 – 15 mm |
| Security grade of rose set | | <input type="checkbox"/> S2-ZA | 8 – 15 mm |
| Set handing | | <input type="checkbox"/> Handle inside pointing right | <input type="checkbox"/> Handle inside pointing left |
| Set to match door thickness | | _____ mm | |
| Centres (C) for PC | <input type="checkbox"/> 72 mm <input type="checkbox"/> 78 mm, CH-RC* <input type="checkbox"/> 72 mm | <input type="checkbox"/> 88* mm | <input type="checkbox"/> 92 mm |
| Square spindle | <input type="checkbox"/> 8 mm <input type="checkbox"/> 9 mm | <input type="checkbox"/> 8.5* mm | <input type="checkbox"/> 10 mm |
| Material/colour | Aluminium Alu. + colour Stainless Steel | <input type="checkbox"/> 0105 <input type="checkbox"/> White <input type="checkbox"/> 6204 | <input type="checkbox"/> _____ <input type="checkbox"/> _____ <input type="checkbox"/> 6205 |

Order quantity: _____ sets

Supplied door handle model:
FSB 1107 (aluminium, aluminium + colour, stainless steel)
Other models available upon request

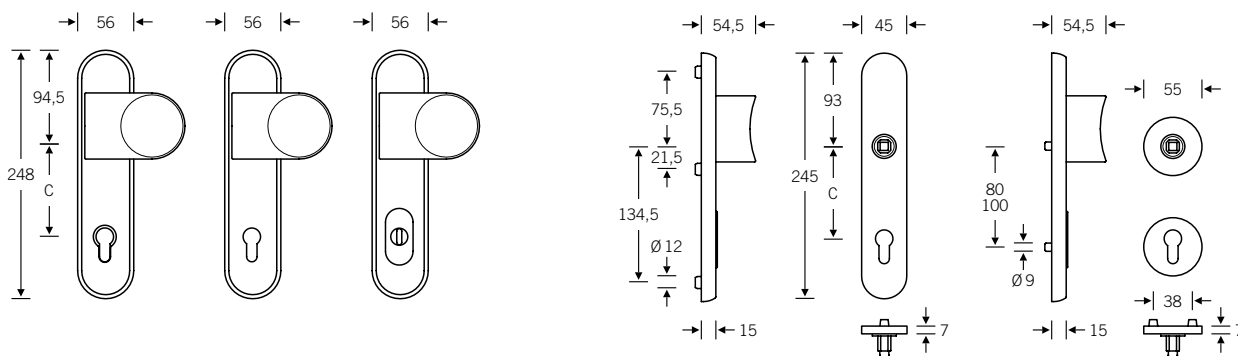

* S2-ZA only



Security fittings

Sets for narrow-stile doors

- Aluminium
- Stainless steel
- Bronze

73 7330

73 7330 030
↻ 73 7530 030

Lever/lever set for narrow-stile doors, lever handles with turnably fixed bearing on both sides, outside backplate 14 mm, inside backplate 7 mm, centres (C) for PC 72 and 92 mm

Square spindle 8 mm
Square spindle 9 mm

73 7330 031
↻ 73 7530 031

Lever/knob set for narrow-stile doors, lever handle with turnably fixed bearing, outside backplate 14 mm, inside backplate 7 mm, centres (C) for PC 72 and 92 mm

Square spindle 8 mm
Square spindle 9 mm

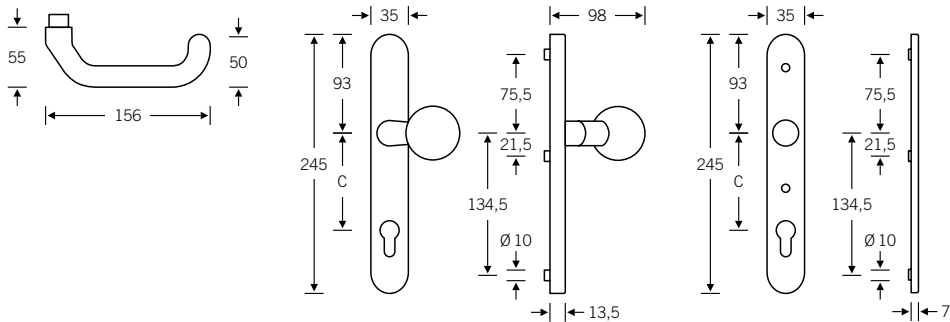

8c



↻ EN 179 model
 Certified under DIN 18257 ES 1

↻ FSB ASL®
↻ FSB AGL®
↻ FS heavy-duty fitting
↻ EN 179 heavy-duty fitting
 For bearings, see page 52 ff.

Security fittings

Sets for narrow-stile doors

- Aluminium
- Stainless steel
- Bronze

73 7331

73 7331 030 (ZA)
🔑 73 7531 030 (ZA)

Lever/lever set for narrow-stile doors with cylinder guard (ZA), lever handles with turnably fixed bearing on both sides, outside backplate 14 mm, inside backplate 7 mm, centres (C) for PC 72 and 92 mm

Square spindle 8 mm
Square spindle 9 mm

Suitable for cylinder projections of 8–13 mm



73 7331 031 (ZA)
🔑 73 7531 031 (ZA)

Lever/knob set for narrow-stile doors with cylinder guard (ZA), lever handle with turnably fixed bearing, outside backplate 14 mm, inside backplate 7 mm, centres (C) for PC 72 and 92 mm

Square spindle 8 mm
Square spindle 9 mm

Suitable for cylinder projections of 8–13 mm

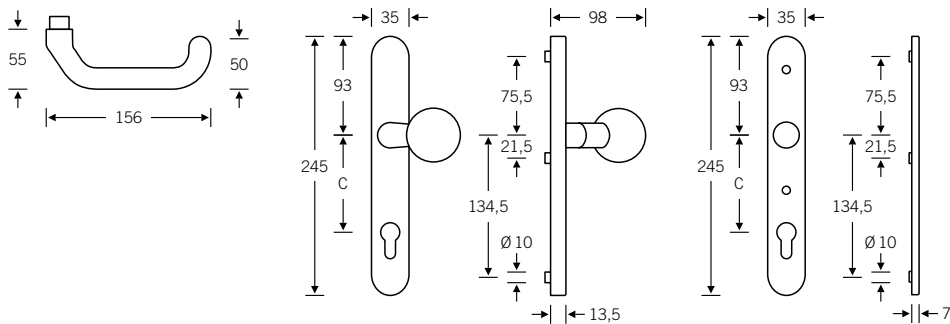

🔑 EN 179 model
 Certified under DIN 18257 ES 1

🔑 FSB ASL®
 🔄 FSB AGL®
🔑 FS heavy-duty fitting
🔑 EN 179 heavy-duty fitting
 For bearings, see page 52 ff.

Security fittings

Security roses for narrow-stile doors

- Aluminium
- Stainless steel
- Bronze

73 3244 



Suitable for cylinder projections of 10–17 mm, screw hole \varnothing 3.2 mm
Screw centres 70 mm

Not certified under DIN 18257 ES 1

The integrated security engineering requires the external dimensions of the security rose to protrude 11 mm beyond screw centres. Please bear this in mind where other fittings are involved.

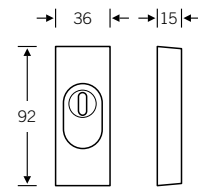

73 3249   



Suitable for cylinder projections of 10–17 mm, screw hole \varnothing 3.2 mm
Screw centres 50 mm

Not certified under DIN 18257 ES 1

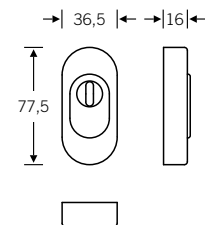

8c

Security fittings

Security roses for flush doors

- Aluminium
- Stainless steel
- Bronze

73 7391 | 73 7392 

73 7391 (14 mm)
73 7392 (10 mm)

Not certified under DIN 18257 ES 1

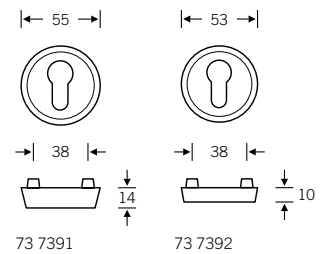

73 7393 

Suitable for cylinder projections
of 8–15 mm

Not certified under DIN 18257 ES 1

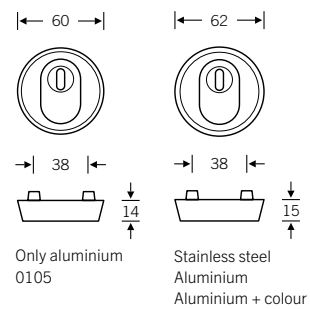

Security fittings

Security roses for flush doors

■ Aluminium
■ Stainless steel
■ Bronze

73 7395 ■ ■ ■



Suitable for cylinder projections (CP) as per table

| Product code | Ø | CP | Height |
|---------------|---------|---------|---------|
| 73 7395 01010 | 61.5 mm | 6.5 mm | 12.5 mm |
| 73 7395 01110 | 62.3 mm | 8.5 mm | 14.5 mm |
| 73 7395 01210 | 63.0 mm | 10.5 mm | 16.5 mm |

Given the cylinder lengths established on the market, these roses can only be used on doors 50 mm thick or more.

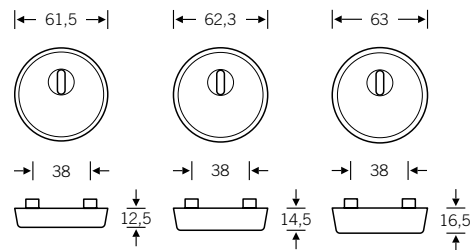

73 7395 ■ ■ ■



Suitable for cylinder projections (CP) as per table

| Product code | Ø | CP* | Height |
|---------------|---------|---------|---------|
| 73 7395 00010 | 61.5 mm | 12.5 mm | 12.5 mm |
| 73 7395 00110 | 62.3 mm | 14.5 mm | 14.5 mm |
| 73 7395 00210 | 63.0 mm | 16.5 mm | 16.5 mm |

* Recommended cylinder projection ± 1.5 mm

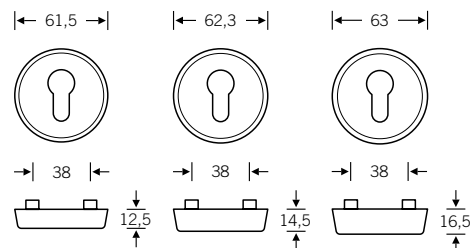

Both security roses have been tested and certified under DIN 18257 ES 1 and DIN 18273 for fire doors.

8c

Security fittings

Security rose for flush doors

- Aluminium
- Stainless steel
- Bronze

73 7397

Tested and certified under DIN 18257 ES 1 and
DIN 18273 for fire doors, with square inside rose

| Product code | | CP | Height |
|---------------|---------|--------|---------|
| 73 7397 01110 | 61.5 mm | 8.5 mm | 14.5 mm |

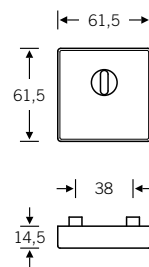

73 7397

Tested and certified according to DIN 18 257 ES 1 and
DIN 18 273 for fire doors, with square inside rose

| Product code | | CP | Height |
|---------------|---------|-------------------------------------------------|--------|
| 73 7397 00110 | 61.5 mm | The cylinder should not protrude more than 3 mm | 15 mm |

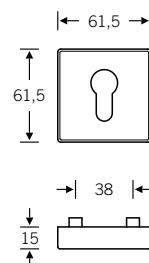

Security fittings

Flush-fitted security rose

- Aluminium
- Stainless steel
- Bronze



73 7396 

73 7396 01010
(with cylinder guard)
73 7396 02010
(without cylinder guard)

- Door thickness 57 mm upwards
- Tested and certified under DIN 18257 ES 1 and DIN 18273 for fire doors
- Set includes flush-fitted variants on both sides
- M5 screws for fixing

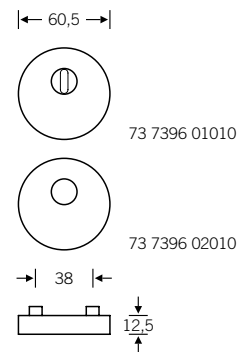

Since flush-fitted installation has no bearing on the security grade, security roses can be installed with a small projection of a few millimetres or be surface-mounted in a 'classic' way.

Suitable routing jig:

FSB 03 0462 00030; see page 782

Order details required:

- Door thickness
- Variant 73 7396 01010 or 02010
- Material/finish
- Quantity

8c

743 **Technical information**
Security fittings

Technical information

Security fittings

Security concept

Modular multilayer design

FSB used its own modular multilayer design developed in-house when design-engineering the FSB 'Design + Security' fittings package. The multilayer design has proven its worth time and time again in practical use and has since become the industry

standard. The level of security set out in the standards is increased from one security grade to the next by replacing and adding materials.

EN 1627–1630

EN 1627 – 1630 are test standards for doors and windows as complete units: the door or window is tested with all of its components (frame, leaf, hinges, closure device, security fittings, lock cylinder, glass). These are superseding standards.

EN 1627 – 1630 specify different resistance classes (RC) which indicate how long a product is able to resist a break-in attempted by a specific type of perpetrator. A higher resistance class means better protection against burglary.

| Resistance class (e.g. door) | Resistance time | Perpetrator profile |
|-------------------------------------------|-----------------|---------------------------------------------------------------------------------------------------------------|
| RC 1 N (N = not security glass) | – | Basic protection against break-in attempts with physical force (kicking in, forcing up, pulling off, etc.) |
| RC 2 N RC 2 (N = not security glass) | 3 minutes | Opportunist breaking in with a simple tool (screwdriver, pliers, etc.) |
| RC 3 | 5 minutes | Opportunist breaking in with a second screwdriver and crowbar/nail puller |
| RC 4 | 10 minutes | Experienced criminal using additional tools such as a saw, hammer, axe, crowbar, chisel, cordless drill, etc. |

EN 1906 and DIN 18257

FSB security fittings (except security roses) have been tested and classified under EN 1906. The products that meet the security grades as defined by EN 1906 are also permitted to be used for the aforementioned resistance classes (RC) set out in EN 1627 – 1630 and are therefore tested with other elements as a complete system. The security grades are defined as S1 to S4. FSB offers backplate sets as security fittings in both security grade S2 (with and without cylinder guard) and S4 (with cylinder guard).

FSB security roses have been tested and classified under DIN 18257 ES 1. The following table shows the different security grades and their requirements.

| EN 1906 FSB security fittings* (backplate sets) | DIN 18257 FSB security roses** | Door | Description |
|-------------------------------------------------------|-----------------------------------|---------------|-----------------------|
| Security grade 1 (S1) | ES 0 | RC 1 N | low resistance |
| * Security grade 2 (S2/S2-ZA) | ** ES 1 or ES 1-ZA | RC 2 N / RC 2 | moderate resistance |
| Security grade 3 (S3) | ES 2 or ES 2-ZA | RC 3 | high resistance |
| * Security grade 4 (S4/S4-ZA) | ES 3 or ES 3-ZA | RC 4 | extra high resistance |

Technical information



Security fittings

Backplate sets

FSB security fittings are delivered as backplate sets for the following door thicknesses as standard:

Internal doors 40–42 mm
 Entrance doors 67–69 mm
 Fire doors 53–57 mm

Explanations for the requirements for security grades S2 and S4

| | Security grade 2 (S2) pursuant to EN 1906 open version | Security grade 2 (S2-ZA) pursuant to EN 1906 with cylinder guard (ZA) | Security grade 4 (S4-ZA) pursuant to EN 1906 with cylinder guard (ZA) |
|----------------------------|---------------------------------------------------------------------------------------------------------------------------------------------------------------------------------------------------------------------|-------------------------------------------------------------------------------------------------------------------------------------------------------------------------|--------------------------------------------------------------------------------------------------------------|
| DIN 18257 | ES 1 K DIN 18257 reg. no. 4X078 ES 1 L DIN 18257 reg. no. 4X076 | ES 1 K-ZA DIN 18257 reg. no. 4X077 ES 1 L-ZA DIN 18257 reg. no. 4X079 | ES 3 L-ZA DIN 18257 reg. no. 4X081 |
| Strength of backplates | 10 kN | 10 kN | 20 kN |
| Max. flexion | ≤ 5 mm | ≤ 5 mm | ≤ 5 mm |
| Tensile strength of fixing | 15 kN | 15 kN | 30 kN |
| Max. deformation | ≤ 5 mm | ≤ 5 mm | ≤ 5 mm |
| Drill resistance | 30 s | 30 s | 5 min |
| Chisel test resistance | 3 strikes | 3 strikes | 12 strikes |
| Strength of cylinder guard | – | 10 kN | 20 kN |
| | Open version  Cylinder projection: 11 mm 15 mm The cylinder should not protrude more than 3 mm. | Cylinder guard (ZA)  | Cylinder guard (ZA)  |
| Product variant | Lever/knob sets in: – Long backplate variant – Short backplate variant as inside and outside backplate Rose variant on inside also possible | Lever/lever and lever/knob sets in: – Long backplate variant – Short backplate variant as inside and outside backplate Rose variant on inside also possible | Lever/knob sets in: – Long backplate variant as inside and outside backplate |

8c

Technical information

Flush-fitted security rose

Routing dimensions

Routing dimensions: outside \varnothing 60.8 mm, depth 12.5 mm (routing bit \varnothing 20 mm, collar ring \varnothing 30 mm), inside \varnothing 55.6 mm, depth 7 mm (routing bit \varnothing 20 mm, collar ring \varnothing 30 mm). Lug drill holes (\varnothing 9 mm) 38 mm apart and at least 7 mm deep on both sides.

Routing on inside

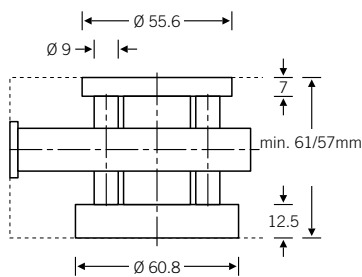

Routing on outside

The routed areas need to be sealed subsequently, especially on the outside of the door!

A routing jig can be found under product code 03 0462 00030 on page 782.

The defining dimension for flush-fitted security rose 73 7396 (door thicknesses of 57 mm upwards) is the distance between the centre of the lock and the outside of the door:

73 7396 01010 (with cylinder guard) at least 33.5 mm

73 7396 02010 (without cylinder guard) 29 mm (due to the securing disc being omitted; has no effect on the security grade)

If the door is of a thinner type or the lock position is less than ideal, 73 7396 without a cylinder guard as opposed to the variant with a cylinder guard helps to compensate for cylinder projections up to 4.5 mm greater or doors up to 4.5 mm thinner.

73 7396 01010

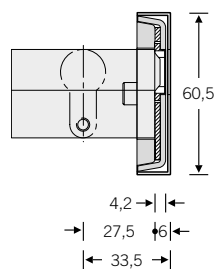

73 7396 02010

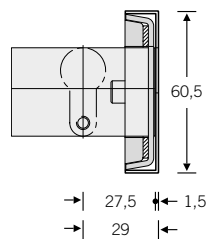

Inside rose:

An additional distance of 27.5 mm from the lock centre to the inside of the door is required if the inside rose is likewise to be flush-fitted. The minimum door thickness required is thus 57 mm.



- 750 Door stops
- 754 Spindles, fixing material and accessories
- 772 Routing jigs and fixing equipment



Quality is expressed even in the details you can't see. In order for handles to stay fixed and secure over the long term, they must be properly assembled and installed. Suitable FSB accessories ensure precise coordination to the products of our range. One well-engineered example of this is the spindle/female handle connection, which is unique on the market and effectively transfers the forces exerted during constant daily use to the door itself. Installing our fittings is also extremely easy thanks to templates and fixing aids. (Pictured: FSB 1242 door handle)

Photo: Roland Borgmann
Project: Haus am Buddenturm
Architectural firm: hehnpohl architektur



750 Door stops

Door stops

■ Aluminium
■ Stainless steel
■ Bronze

38 3816 ■ ■

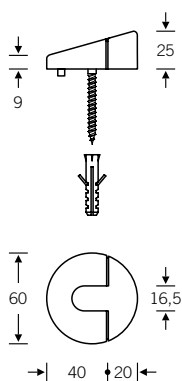

38 3888 ■

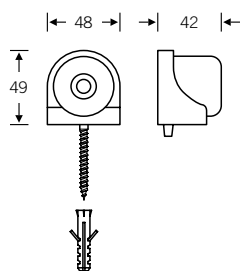

38 3884 ■ ■ ■

38 3884 00000 Door stops
38 3884 00010 Black baseplate

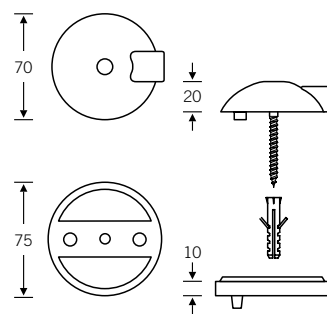

38 3878 ■ ■ ■

Design: Christoph Ingenhoven

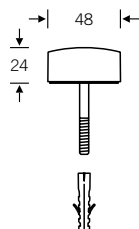

38 3881 ■ ■ ■

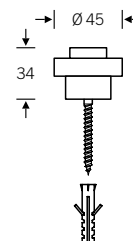

It is necessary before ordering or fitting door stops to ascertain the weight of the door, its angle of impact, the height of its bottom edge above the floor and the strength of the floor.

Depending on what's actually required, it is possible to choose between basic stops, stops with anti-twist protection, stops with baseplates and directional/non-directional stops as well as between basic floor fixing or advanced fixing with plugs.

Door stops

- Aluminium
- Stainless steel
- Bronze

38 3895 ■

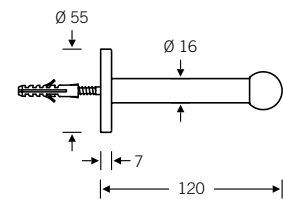

38 3896 ■ ■

Design: Jasper Morrison

- 38 3896 00002 (120 mm)
- 38 3896 00003 (90 mm)
- 38 3896 00004 (60 mm)

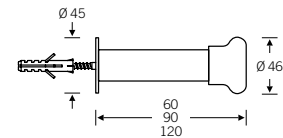

38 3880 ■ ■ ■

- 38 3880 00001 Rubber door stop
- 38 3880 00002 wall-mounted stop, 120 mm
- 38 3880 00003 wall-mounted stop, 90 mm
- 38 3880 00004 wall-mounted stop, 60 mm

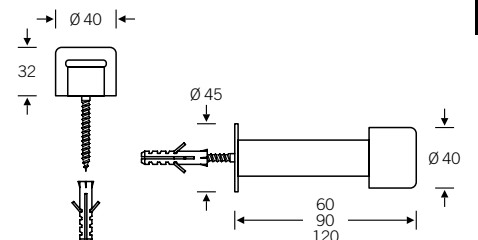

9a

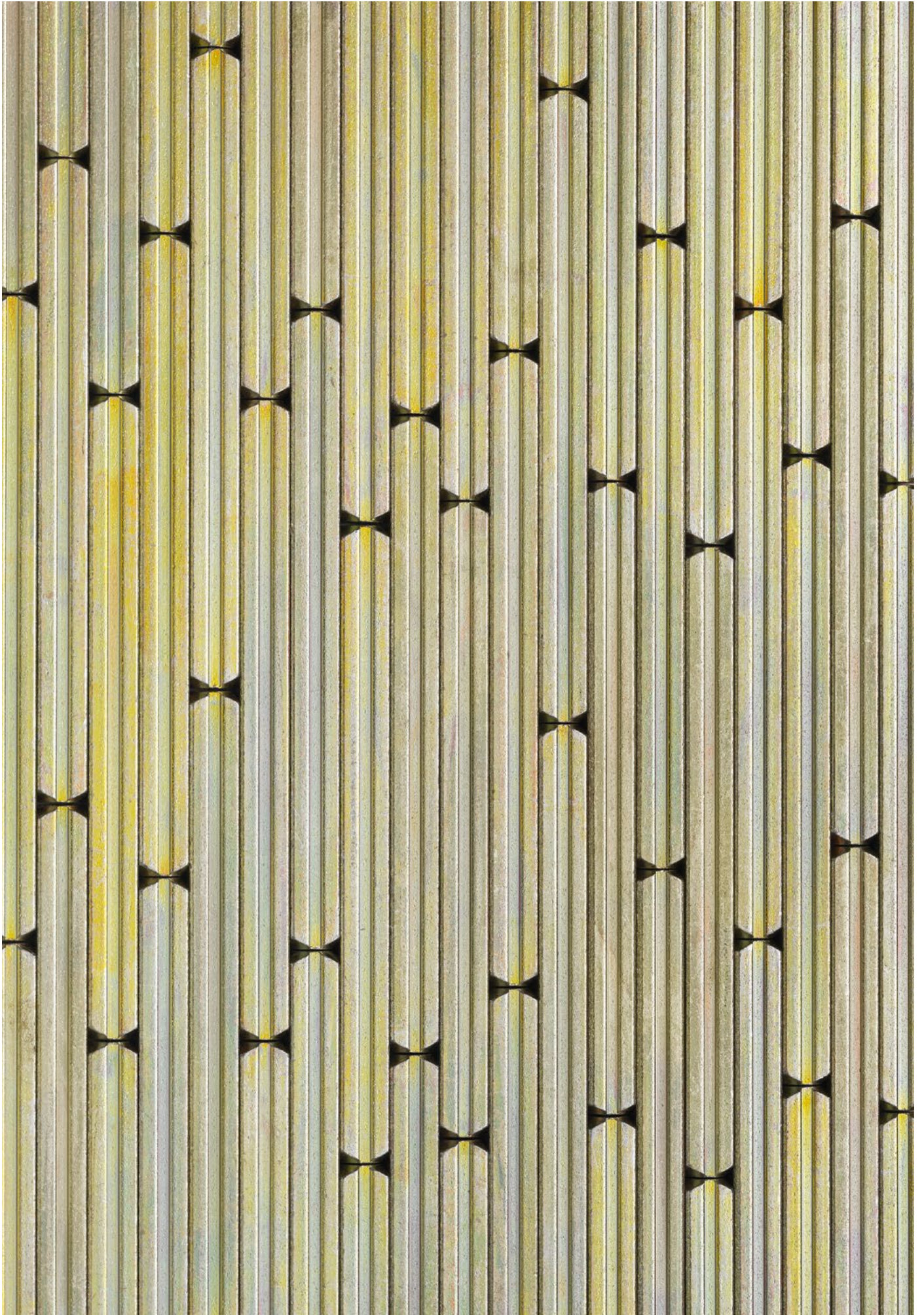

754 Spindles, fixing material and accessories

Spindles, fixing material and accessories

Overview

Half-spindles

05 0115 | 05 0116
Page 765



05 0117
Page 759



05 0117
Page 763



05 0117
Page 761



Full spindles

05 0118
Page 758



05 0118
Page 760



05 0122 | 05 0123
Page 762



05 0188 | 05 0189
Page 764



Special spindles

05 0525
Page 766



05 0125
Page 768



Fixing material

05 0526
Page 767



05 0526
Page 767



Grub screws and studs

05 0303
Page 769



05 0309
Page 769



05 0313
Page 770



05 0315
Page 770



05 0316
Page 770



Accessories

05 0320
Page 771



05 0325
Page 771



03 0410
Page 771



05 0425
Page 771

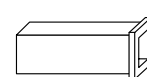

03 0450
Page 771



Note:

FSB supplied the companion screws and spindles in an accessory bag as standard for the following products:

- FSB ASI® sets
- FSB AGL® (FS) sets
- Security fittings
- Backplates with visible fixing
- Flush-fitted roses
- Cut roses and backplates
- Broad backplates/renovation backplates

The screws and rivet nuts are supplied for narrow-stile door fittings. The spindle must be ordered separately. The associated spindles can be found on the following pages.

The individual parts can also be ordered separately for all products that originally come with the accessory bag if there are different door thicknesses or parts need to be reordered. You can also find these parts in the following chapter.

Spindles, fixing material and accessories

Full spindles with groove

05 0118



FSB full spindles
with groove, 8 mm, for female lever handles and knobs
in combination with:

- FSB ASL® sets
- FSB AGL® sets
- Security fittings
- Roses and backplates for narrow-stile doors
- Backplates with visible fixing
- Flush-fitted roses
- Cut roses and backplates
- Broad backplates/renovation backplates

Use scenario: lever handles on both sides

| | |
|--------------------|------------|
| 05 0118 00810 5700 | 8 × 60 mm |
| 05 0118 00812 5700 | 8 × 65 mm |
| 05 0118 00814 5700 | 8 × 70 mm |
| 05 0118 00818 5700 | 8 × 80 mm |
| 05 0118 00822 5700 | 8 × 90 mm |
| 05 0118 00826 5700 | 8 × 100 mm |
| 05 0118 00830 5700 | 8 × 110 mm |
| 05 0118 00832 5700 | 8 × 115 mm |
| 05 0118 00834 5700 | 8 × 120 mm |
| 05 0118 00838 5700 | 8 × 130 mm |
| 05 0118 00840 5700 | 8 × 135 mm |
| 05 0118 00842 5700 | 8 × 140 mm |
| 05 0118 00846 5700 | 8 × 150 mm |
| 05 0118 00848 5700 | 8 × 155 mm |
| 05 0118 00850 5700 | 8 × 160 mm |
| 05 0118 00856 5700 | 8 × 175 mm |
| 05 0118 00866 5700 | 8 × 200 mm |

It is not possible to specify a specific door thickness range.
The spindle should be inserted 25 mm into the adaptor on
each side.

Spindles, fixing material and accessories

Half-spindles with groove

05 0117



FSB half-spindles
with groove, 8 mm, for flush and narrow-stile doors
with M12 threaded plug, for rotatable bearing in neck of
knob, tool size 13 mm

For female lever handles and knobs in combination with:

- FSB ASL® lever/knob sets
- FSB AGL® lever/knob sets
- Security fittings
- Backplates with visible fixing
- Knob backplates with visible fixing

Use scenario: fixed knob/knob backplate on one side,
lever handle on the other

| | |
|--------------------|------------|
| 05 0117 00822 5700 | 8 × 90 mm |
| 05 0117 00826 5700 | 8 × 100 mm |
| 05 0117 00830 5700 | 8 × 110 mm |
| 05 0117 00834 5700 | 8 × 120 mm |
| 05 0117 00838 5700 | 8 × 130 mm |
| 05 0117 00842 5700 | 8 × 140 mm |
| 05 0117 00846 5700 | 8 × 150 mm |
| 05 0117 00850 5700 | 8 × 160 mm |
| 05 0117 00854 5700 | 8 × 170 mm |

It is not possible to specify a specific door thickness range.

For female lever handles and knobs in combination with:

- Roses and backplates for narrow-stile doors

| | | Door thickness, symmetrical knob | Door thickness, cranked knob |
|--------------------|------------|----------------------------------------|---------------------------------|
| 05 0117 00820 5700 | 8 × 85 mm | 27–31 mm | 35–39 mm |
| 05 0117 00822 5700 | 8 × 90 mm | 32–36 mm | 40–44 mm |
| 05 0117 00824 5700 | 8 × 95 mm | 37–41 mm | 45–49 mm |
| 05 0117 00826 5700 | 8 × 100 mm | 42–46 mm | 50–54 mm |
| 05 0117 00828 5700 | 8 × 105 mm | 47–51 mm | 55–59 mm |
| 05 0117 00830 5700 | 8 × 110 mm | 52–56 mm | 60–64 mm |
| 05 0117 00832 5700 | 8 × 115 mm | 57–61 mm | 65–69 mm |
| 05 0117 00834 5700 | 8 × 120 mm | 62–66 mm | 70–74 mm |
| 05 0117 00836 5700 | 8 × 125 mm | 67–71 mm | 75–79 mm |
| 05 0117 00838 5700 | 8 × 130 mm | 72–76 mm | 80–84 mm |
| 05 0117 00840 5700 | 8 × 135 mm | 77–81 mm | 85–89 mm |
| 05 0117 00844 5700 | 8 × 145 mm | 82–86 mm | 95–99 mm |

9b

Spindles, fixing material and accessories

Full spindles with groove, fire safety

05 0118



FSB full spindles
with groove, conforming to DIN 18273 fire safety, 9 mm,
for female lever handles in combination with:

– Narrow-stile door fittings

Use scenario: lever handles on both sides

| | |
|--------------------|------------|
| 05 0118 01910 5700 | 9 × 60 mm |
| 05 0118 01914 5700 | 9 × 70 mm |
| 05 0118 01918 5700 | 9 × 80 mm |
| 05 0118 01922 5700 | 9 × 90 mm |
| 05 0118 01926 5700 | 9 × 100 mm |
| 05 0118 01930 5700 | 9 × 110 mm |
| 05 0118 01934 5700 | 9 × 120 mm |
| 05 0118 01938 5700 | 9 × 130 mm |
| 05 0118 01942 5700 | 9 × 140 mm |
| 05 0118 01946 5700 | 9 × 150 mm |
| 05 0118 01950 5700 | 9 × 160 mm |
| 05 0118 01954 5700 | 9 × 170 mm |
| 05 0118 01962 5700 | 9 × 190 mm |

It is not possible to specify a specific door thickness range.
The spindle should be inserted 25 mm into the adaptor on
each side.

These square spindles must only be used in combination
with tested FSB FS lever handles for narrow-stile doors.

Spindles, fixing material and accessories

Half-spindles with groove, fire safety

05 0117

FSB half-spindles with groove, pursuant to DIN 18273 fire safety, 9 mm, with M12 threaded plug, for rotatable bearing in neck of knob, tool size 13 mm, for female lever handles in combination with:

– Narrow-stile door fittings, FS

Use scenario: fixed knob on one side, lever handle for narrow-stile door on the other



| | | Door thickness, symmetrical knob knob | Door thickness, cranked |
|--------------------|------------|---------------------------------------------|----------------------------|
| 05 0117 01918 5700 | 9 × 80 mm | 22–26mm | 30–34mm |
| 05 0117 01920 5700 | 9 × 85 mm | 27–31mm | 35–39mm |
| 05 0117 01922 5700 | 9 × 90 mm | 32–36mm | 40–44mm |
| 05 0117 01924 5700 | 9 × 95 mm | 37–41mm | 45–49mm |
| 05 0117 01926 5700 | 9 × 100 mm | 42–46mm | 50–54mm |
| 05 0117 01928 5700 | 9 × 105 mm | 47–51mm | 55–59mm |
| 05 0117 01930 5700 | 9 × 110 mm | 52–56mm | 60–64mm |
| 05 0117 01932 5700 | 9 × 115 mm | 57–61mm | 65–69mm |
| 05 0117 01934 5700 | 9 × 120 mm | 62–66mm | 70–74mm |
| 05 0117 01936 5700 | 9 × 125 mm | 67–71mm | 75–79mm |
| 05 0117 01938 5700 | 9 × 130 mm | 72–76mm | 80–84mm |
| 05 0117 01940 5700 | 9 × 135 mm | 77–81mm | 85–89mm |
| 05 0117 01944 5700 | 9 × 145 mm | 82–86mm | 95–99mm |

These square spindles must only be used in combination with tested FSB fittings for narrow-stile doors.

Spindles, fixing material and accessories

Full spindles with groove, stepped on both sides

05 0122 | 05 0123



FSB full spindles
with groove, stepped on both sides, for female lever
handles in combination with:

- FSB ASL® sets
- Narrow-stile door fittings

Use scenario: lever handles on both sides

Further application areas are possible where a stepped
spindle is required.

| | |
|--------------------|-----------------|
| 05 0122 01026 5700 | 8/10/8 × 100 mm |
| 05 0122 01030 5700 | 8/10/8 × 110 mm |
| 05 0122 01034 5700 | 8/10/8 × 120 mm |
| 05 0122 01038 5700 | 8/10/8 × 130 mm |
| 05 0122 01042 5700 | 8/10/8 × 140 mm |
| 05 0122 01046 5700 | 8/10/8 × 150 mm |
| 05 0122 01050 5700 | 8/10/8 × 160 mm |
| 05 0122 01054 5700 | 8/10/8 × 170 mm |

| | |
|--------------------|-----------------------|
| 05 0123 08524 5700 | 8/8.5/8 × 95 mm (AT) |
| 05 0123 08530 5700 | 8/8.5/8 × 110 mm (AT) |
| 05 0123 08534 5700 | 8/8.5/8 × 120 mm (AT) |
| 05 0123 08538 5700 | 8/8.5/8 × 130 mm (AT) |
| 05 0123 08542 5700 | 8/8.5/8 × 140 mm (AT) |
| 05 0123 08546 5700 | 8/8.5/8 × 150 mm (AT) |
| 05 0123 08550 5700 | 8/8.5/8 × 160 mm (AT) |
| 05 0123 08554 5700 | 8/8.5/8 × 170 mm (AT) |

Spindles, fixing material and accessories

Half-spindles with groove, stepped

05 0117



FSB half-spindles for flush doors with groove, stepped, 8 mm spindle / 10 mm lock follower, with M12 threaded plug, for rotatable bearing in neck of knob, tool size 13 mm, for female lever handles and knobs in combination with:

- FSB ASL® lever/knob sets
- FSB AGL® lever/knob sets
- Security fittings
- Backplates with visible fixing
- Knob backplates with visible fixing

Use scenario: fixed knob/knob backplate on one side, lever handle on the other

| | |
|--------------------|---------------|
| 05 0117 01020 5700 | 8/10 × 85 mm |
| 05 0117 01024 5700 | 8/10 × 95 mm |
| 05 0117 01028 5700 | 8/10 × 105 mm |
| 05 0117 01032 5700 | 8/10 × 115 mm |
| 05 0117 01036 5700 | 8/10 × 125 mm |
| 05 0117 01040 5700 | 8/10 × 135 mm |
| 05 0117 01044 5700 | 8/10 × 145 mm |

| | |
|--------------------|---------------------|
| 05 0120 08520 5700 | 8/8.5 × 85 mm (AT) |
| 05 0120 08524 5700 | 8/8.5 × 95 mm (AT) |
| 05 0120 08528 5700 | 8/8.5 × 105 mm (AT) |
| 05 0120 08532 5700 | 8/8.5 × 115 mm (AT) |
| 05 0120 08536 5700 | 8/8.5 × 125 mm (AT) |
| 05 0120 08540 5700 | 8/8.5 × 135 mm (AT) |
| 05 0120 08544 5700 | 8/8.5 × 145 mm (AT) |

It is not possible to specify a specific door thickness range.

Spindles, fixing material and accessories

Full spindles for narrow-stile door fittings, stepped on one side

05 0188 | 05 0189

FSB full spindles
stepped on one side, for female lever handles in combination with:

– Narrow-stile door fittings, not FS

Use scenario: lever handle on one side



| | |
|---------------|--------------|
| 05 0188 00910 | 9/8 × 60 mm |
| 05 0188 00916 | 9/8 × 75 mm |
| 05 0188 00934 | 9/8 × 120 mm |

| | |
|---------------|---------------|
| 05 0189 01010 | 10/8 × 60 mm |
| 05 0189 01016 | 10/8 × 75 mm |
| 05 0189 01018 | 10/8 × 80 mm |
| 05 0189 01026 | 10/8 × 100 mm |
| 05 0189 01030 | 10/8 × 110 mm |

Spindles, fixing material and accessories

Half-spindles for flush doors

05 0115 | 05 0116



FSB half-spindles for doors with bolt through-fixing, not suitable for locks with self-tightening follower, for female lever handles and knobs in combination with:

- FSB ASL® sets
- FSB AGL® sets
- Security fittings
- Backplates with visible fixing
- Cut roses and backplates
- Broad backplates/renovation backplates

| | | Cavity dimension (X) |
|---------------|---------------|----------------------|
| 05 0115 00710 | 7 × 60 mm | 20–24 mm |
| 05 0115 00714 | 7 × 70 mm | 30–34 mm |
| 05 0115 00810 | 8 × 60 mm | 20–24 mm |
| 05 0115 00812 | 8 × 65 mm | 25–29 mm |
| 05 0115 00814 | 8 × 70 mm | 30–34 mm |
| 05 0115 00816 | 8 × 75 mm | 35–39 mm |
| 05 0115 00818 | 8 × 80 mm | 40–44 mm |
| 05 0115 01010 | 10 × 60 mm | 20–24 mm |
| 05 0115 01012 | 10 × 65 mm | 25–29 mm |
| 05 0115 01014 | 10 × 70 mm | 30–34 mm |
| 05 0115 01016 | 10 × 75 mm | 35–39 mm |
| 05 0115 01018 | 10 × 80 mm | 40–44 mm |
| 05 0115 01022 | 10 × 90 mm | 50–54 mm |
| 05 0115 01026 | 10 × 100 mm | 60–64 mm |
| 05 0116 01012 | 8/10 × 65 mm | 25–29 mm* |
| 05 0116 01014 | 8/10 × 70 mm | 30–34 mm* |
| 05 0116 01016 | 8/10 × 75 mm | 35–39 mm* |
| 05 0116 01018 | 8/10 × 80 mm | 40–44 mm* |
| 05 0116 01022 | 8/10 × 90 mm | 50–54 mm* |
| 05 0116 01026 | 8/10 × 100 mm | 60–64 mm* |

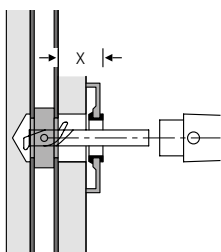

* stepped, 8 mm handle perforation / 10 mm lock follower

9b

Base your selection of the right FSB half-spindle on the cavity dimension (X). The cavity dimension (X) is the distance from the top edge of the backplate or rose shank to the top edge of the lock follower.

Spindles, fixing material and accessories

Special spindles for narrow-stile door fittings

05 0525

FSB square spindles for connecting narrow-stile door fittings, 8 and 9 mm special spindles for narrow-stile doors, suitable for connecting two lever handles for narrow-stile doors (cranked/ cranked, cranked/in-line, in-line/in-line) using cup-point grub screws

Female-handle side



05 0525 028(9)..

Male-handle side

| Accessory bag | Spindle length | Door thickness |
|---------------|----------------|----------------|
| 8 mm | | |
| 05 0525 02804 | 96 mm | 35– 44 mm |
| 05 0525 02805 | 106 mm | 45– 54 mm |
| 05 0525 02806 | 116 mm | 55– 64 mm |
| 05 0525 02807 | 126 mm | 65– 74 mm |
| 05 0525 02808 | 136 mm | 75– 84 mm |
| 05 0525 02809 | 146 mm | 85– 94 mm |
| 05 0525 02810 | 156 mm | 95– 104 mm |
| 9 mm | | |
| 05 0525 02904 | 93 mm | 35– 44 mm |
| 05 0525 02905 | 103 mm | 45– 54 mm |
| 05 0525 02906 | 113 mm | 55– 64 mm |
| 05 0525 02907 | 123 mm | 65– 74 mm |
| 05 0525 02908 | 133 mm | 75– 84 mm |
| 05 0525 02909 | 143 mm | 85– 94 mm |
| 05 0525 02910 | 153 mm | 95– 104 mm |

Spindles, fixing material and accessories

Fixing material for narrow-stile door fittings

05 0526



Fixing set for narrow-stile door fittings with through-fixing to SSF locks for narrow-stile doors (series 01 and 02)

Associated spindle:
05 0525 028.. (8 mm) or
05 0525 029.. (9 mm)
See page 766

Includes screws, metal stabiliser lugs (additionally fixed on one side with M5 screw)

Accessory bag

Screw length

Door thickness

05 0526 01045

50 mm

45 – 49 mm

05 0526 01050

55 mm

50 – 54 mm

05 0526 01055

60 mm

55 – 59 mm

05 0526 01060

65 mm

60 – 64 mm

05 0526 01065

70 mm

65 – 69 mm

05 0526 01070

75 mm

70 – 74 mm

05 0526 01075

80 mm

75 – 79 mm

05 0526 01080

85 mm

80 – 84 mm

05 0526 01085

90 mm

85 – 89 mm

05 0526 01090

95 mm

90 – 94 mm

05 0526 01095

100 mm

95 – 99 mm

05 0526 01000

105 mm

100 – 104 mm

05 0526



Fixing material for narrow-stile door fittings

Screws M5 × 25 mm and rivet nuts

Spindles, fixing material and accessories

Special spindle for FSB AGL® FS EN 179 sets

05 0125



FSB special spindle
pursuant to DIN 18273 fire safety,
for locks with split follower

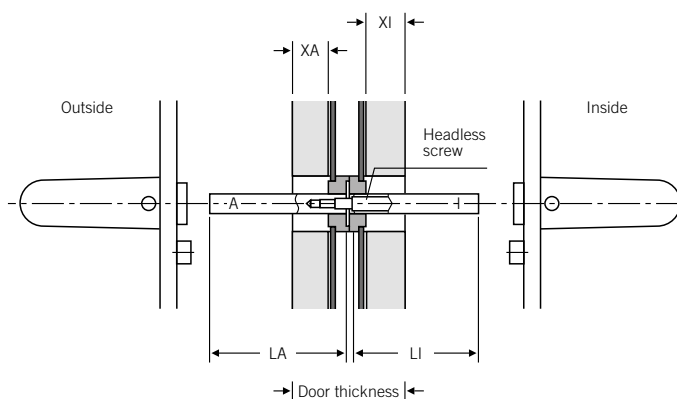

The FSB special spindle (9 mm), which has been tested and approved under DIN 18273 and is assigned product code 05 0125, is available for locks with a split follower and can accommodate door thicknesses of 34 – 101 mm assuming the lock is positioned centrally.

Please provide the following details when ordering:

- Door thickness
- Dimensions XA and XI
- Product code of the FSB set used to determine the correct spindle length

For further information on using FSB fittings on emergency exit devices pursuant to EN 179, please consult the relevant FSB declaration of performance. It is important when using the FSB special spindle for locks with a split follower not only to heed building regulations but also to bear in mind that panic fittings (lock, cylinder, spindle, handles, etc.) are intended solely for use in an emergency and must not be fitted to doors in constant operation.

DIN 18273 additionally states that it is inadmissible to piece together fire safety sets out of random combinations of parts by any one manufacturer or to mix components of fire safety and smoke control sets from more than one manufacturer.

FSB advises heeding the statements and recommendations made by the lock and fittings industries in this respect. Building-authority approval of FSB special spindle 05 0125 for locks with a split follower applies in conjunction with certified FSB fittings.

Installation instructions

1. From the outside of the door, insert the spindle section marked 'A' into the lock follower as far as the coupling washer.
2. From the inside of the door, likewise push the spindle section marked 'I' into the lock follower as far as the coupling washer, and then screw both sections together through the coupling washer using the headless screw.
3. Now slide the lever handles with turnably fixed bearing onto the spindles together with their backplates or roses.
4. Ensure that there is no play when fitting backplates or roses to the door, as even the slightest degree of misalignment can lead to the connection between the two halves of the spindle being ruptured when the handles are operated.
5. Finally, tighten the cup-point grub screws in the levers securely against the spindle on both sides. The heads of the grub screws must be flush with the surface of the lever handle.

Spindles, fixing material and accessories

Screws

05 0303

Cross-recessed oval head
countersunk screw

05 0303 00515 M5 × 15 mm
05 0303 00535 M5 × 35 mm



05 0308

Cross-recessed
countersunk screws

05 0308 00545 M5 × 45 mm
05 0308 00555 M5 × 55 mm
05 0308 00560 M5 × 60 mm
05 0308 00565 M5 × 65 mm
05 0308 00570 M5 × 70 mm
05 0308 00575 M5 × 75 mm
05 0308 00585 M5 × 85 mm
05 0308 00595 M5 × 95 mm
05 0308 00501 M5 × 105 mm

05 0309

Bolts with
M4 threaded sleeve nut

Screw length Usable length Door thickness

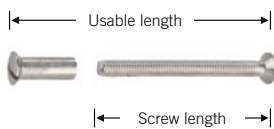

| | | | |
|---------------|-------|----------|----------|
| 05 0309 00435 | 35 mm | 39–44 mm | 25–30 mm |
| 05 0309 00440 | 40 mm | 44–49 mm | 30–35 mm |
| 05 0309 00445 | 45 mm | 49–54 mm | 35–40 mm |
| 05 0309 00450 | 50 mm | 54–59 mm | 40–45 mm |
| 05 0309 00455 | 55 mm | 59–64 mm | 45–50 mm |
| 05 0309 00460 | 60 mm | 64–69 mm | 50–55 mm |
| 05 0309 00465 | 65 mm | 69–74 mm | 55–60 mm |
| 05 0309 00470 | 70 mm | 74–79 mm | 60–65 mm |
| 05 0309 00475 | 75 mm | 79–84 mm | 65–70 mm |
| 05 0309 00480 | 80 mm | 84–89 mm | 70–75 mm |

Door thickness applies to use of roses and backplates with a height of 7 mm

9b

Spindles, fixing material and accessories

Grub screws and studs

05 0313



Grub screws

05 0313 00670 M6 × 70 mm
05 0313 00680 M6 × 80 mm
05 0313 00690 M6 × 90 mm
05 0313 00600 M6 × 100 mm

05 0313 00840 M8 × 40 mm
05 0313 00850 M8 × 55 mm
05 0313 00860 M8 × 60 mm
05 0313 00870 M8 × 70 mm
05 0313 00880 M8 × 80 mm
05 0313 00800 M8 × 100 mm

05 0315



Cross-recessed countersunk tapping screw

2.9 × 16 mm
3.9 × 16 mm
4.2 × 19 mm

05 0316



Headless wood screws

05 0316 00640
M6 variant:
Overall length 40 mm
Length of M6 threading:
10 mm

05 0316 00840
M8 variant:
Overall length 40 mm
Length of M8 threading:
15 mm

Spindles, fixing material and accessories

Accessories

05 0320



Domed nuts

Aluminium
Stainless steel
05 0320 00800 M8

05 0325



Blind nut
with shank 12 mm

Aluminium
05 0325 00600 M6
05 0325 00800 M8

03 0410



FSB socket key
for half-spindles with plug

05 0425

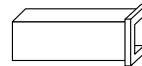

Adaptor sleeve
for lever handle spindle
and lock follower

05 0425 00809
8 to 9.0 mm

05 0425 00810
8 to 10.0 mm

05 0425 00910
9 to 10.0 mm

05 0425 01885
8 to 8.5 mm

03 0450



Grub screw
M6 x 8 mm DIN 916 Tuflok

03 0450 09230 6001
for door handles in
0105, 0205, 6204, 6205

03 0450 09230 6021
for door handles in
0410, 0510, 0710, 0810,
7615, 7625

9b



772 Routing jigs and fixing equipment

Routing jigs and fixing equipment

Fast and proper

FSB lever/lever sets have to be fitted correctly if they are to function properly.

It is FSB policy to supply paper positioning templates with all orders. If these have inadvertently not been enclosed, please request them immediately. The product codes are listed in the footers of the following pages.

FSB supplies metal templates for trade installers. The product codes for these are specified on the following pages.

A considerable amount of force is exerted when operating lever/lever sets. This holds particularly true for fittings on frequently used doors. Long-term trouble-free use can only be guaranteed if sufficient care is taken when drilling and fixing the sets.

FSB has looked very carefully into the complaints received over past years. It often transpires that the reason the goods were faulty was that they were incorrectly fitted. The principal causes were as follows:

- The stabiliser lugs on roses and backplates had broken off, making it impossible to hold fittings securely in place.
- Fittings were ordered for the wrong door thickness: the spindles were either too long and then manually shortened, or too short, forcing the handles to be fitted too near to the end and causing the spindle to break.
- When connecting lever/lever sets, the grub screw was not screwed into the handle neck tightly enough, meaning that the female handle and spindle were not able to interlock fully.
- Drill holes were made freehand without using a template. Backplates and roses moved about in the oversized mounting holes.
- FSB fittings were combined with spindles, screws, backplates and roses from other manufacturers.

Please note that a warranty is only valid for FSB products if the fittings have been correctly and professionally fitted using the dedicated accessories supplied by FSB.

It is also important to note that public awareness of product liability is growing. Improperly installed door and window fittings and their accessories can pose serious risks in terms of potential product liability claims.

Routing jigs and fixing equipment

Universal template

03 0460



In addition to a wide range of dedicated templates, FSB has developed a universal template covering virtually every drill hole layout. This universal template should be a part of every trade installer's standard equipment.

Contents:

- 1 Metal template
- 2 Drilling templates*
- 3 Guide pins
- 4 Knurled screw
- 5 Drill bits
- 6 Adaptor for bigger door thicknesses of approx. 60 mm upwards, depending on lock position

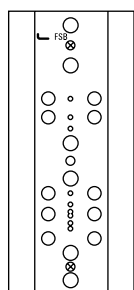

1

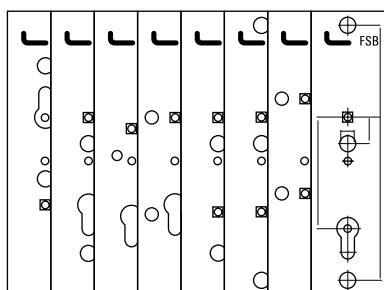

2

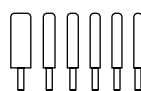

3



4



5



6

Instructions for use:

1. Select the desired drill hole layout from the paper templates.
2. Slot the selected drill hole layout into the guide of the metal template from the front.
3. Firmly secure the drill hole layout with the knurled screw.
4. Select guide pins for the lock follower (7 mm, 8 mm, 9 mm, 10 mm) and keyway (warded lock, profile cylinder, thumb turn) to suit the dimensions of the lock in question and screw them into the metal template from the back until you can see them in the drill hole layout from the front.
5. Having attached the now-assembled universal template to the door lock, drill the holes as indicated on either side.
6. Remove the template and install the FSB sets as per the fixing instructions.

* Drilling templates can also be ordered separately under product code 03 0450 09145 9801

Routing jigs and fixing equipment

Template for short backplates with visible fixing

03 0453

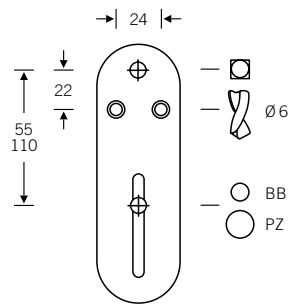

Fixing template for
standard FSB short backplates, fitted with
stabiliser lugs and with option of visible
fixing

Variable use for
WL, PC, WC 55 – 78 mm

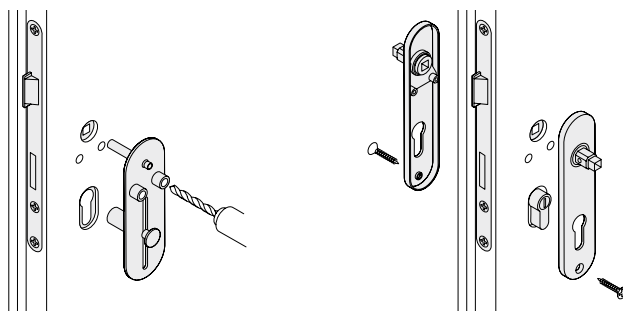

Paper template

78 8429 00252
for FSB short backplates with stabiliser
lugs, standard and WC sets

Routing jigs and fixing equipment

Template for rose sets

03 0455

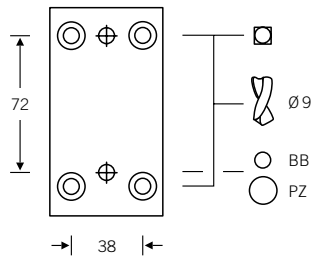

03 0455 00000
WL and PC 72 mm

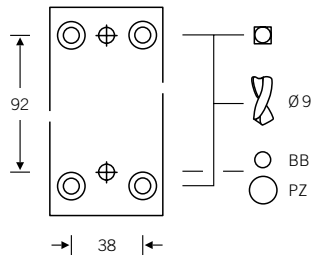

03 0455 00012
WL and PC 92 mm

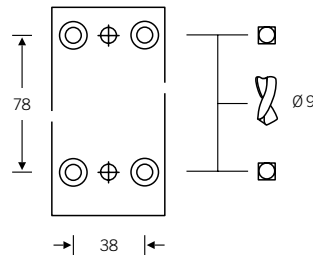

03 0455 05608
WC 78 mm

Fixing templates for all FSB roses designed for concealed fixing:

- FSB handle and key roses for FSB ASL®, FSB AGL® and FSB AGL® fire safety
- FSB security roses
- FSB security fittings with rose fixing

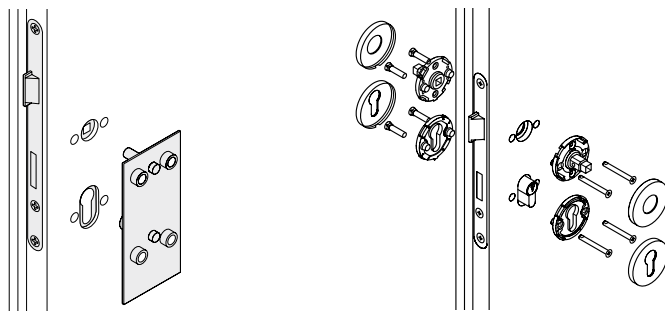

Paper templates

78 8429 00250
for FSB ASL® rose sets and FSB AGL® + FSB AGL® fire safety heavy-duty sets

78 8429 00251
for FSB ASL® and FSB AGL® WC roses

9c

Routing jigs and fixing equipment

Template for lever handles with privacy function

03 0455

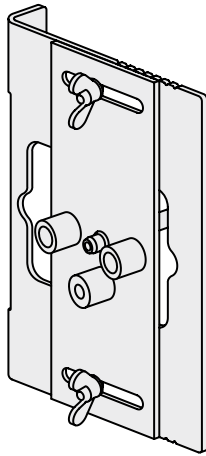

03 0455 03000

Fixing template for
roses for lever handle with privacy function

The drill hole in the lock is positioned below the lock follower in order to operate the emergency release from the outside of the door. Template 03 0455 03000 with side attachment for precise preparation of the door – based on the backset – is provided for this.

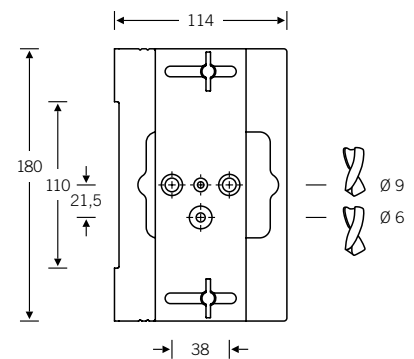

Routing jigs and fixing equipment

Template for crossbar fittings

03 0457

77 7970 00110
77 7970 00200

77 7980 0..10
77 7980 0..00

77 7981 0..10
77 7981 0..00

Fixing templates for
FSB crossbar fittings

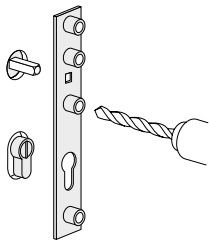
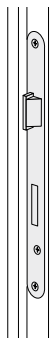
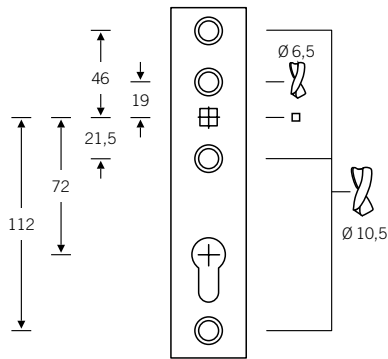

Insert FSB special spindle 05 0125 into the lock and fit the cylinder. Push the drilling template onto the spindle and cylinder and drill through the bushings. Repeat the process on the hinge side. Then work out the lengths of the crossbar and reinforcement bar: these are calculated by multiplying the backset by two, adding a further 68 mm and then subtracting this figure from the width of the door. Once the bars have been cut to size, insert plastic end caps into the tube, if the tube is stainless

steel. Assembling the panic hardware and connecting it to the reverse-face fitting is very straightforward. Full instructions are enclosed with the fitting. Once the stop device has been adjusted (77 7970 only) and the cover caps have been fitted, check the fitting to ensure it is working properly.

79 8430 00085
Fixing instructions for
FSB crossbar fitting 77 7970

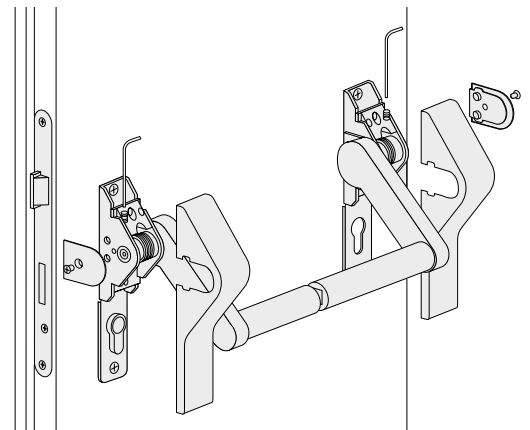
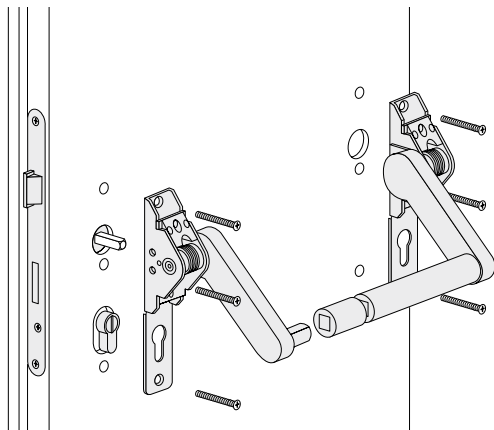
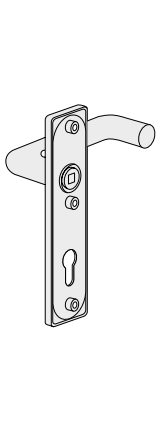

9c

Routing jigs and fixing equipment

Routing jig for sliding door handles

03 0462

03 0462 00020

Routing jig for
sliding door handles 42 4250 – 42 4254

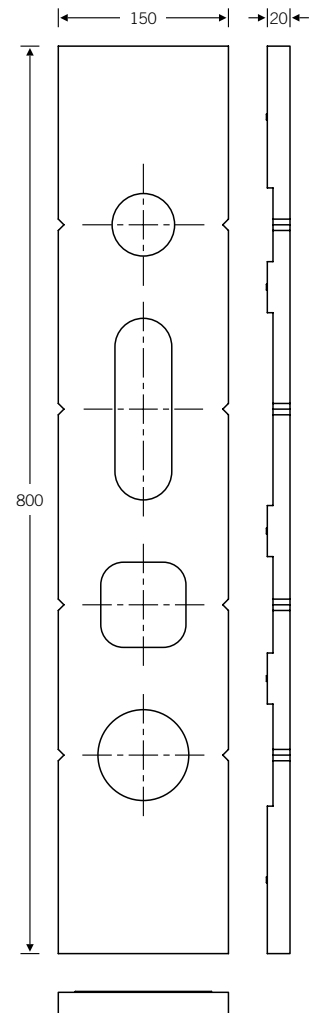
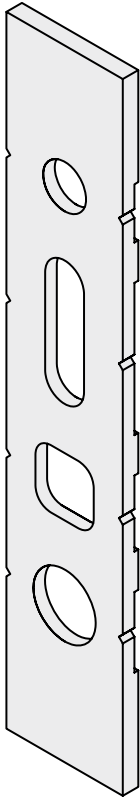

Routing jigs and fixing equipment

Routing jig for sliding door handles

03 0462

03 0462 00050

Routing jig for
sliding door handles 42 4260 – 42 4265

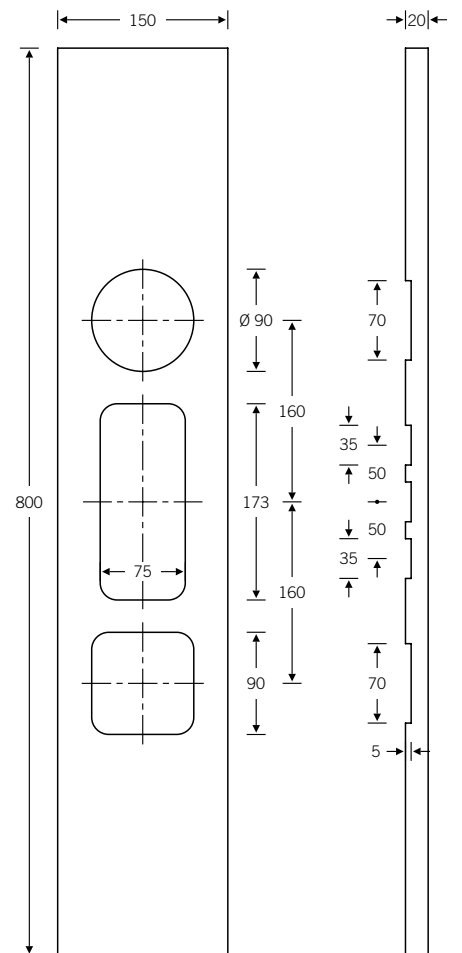
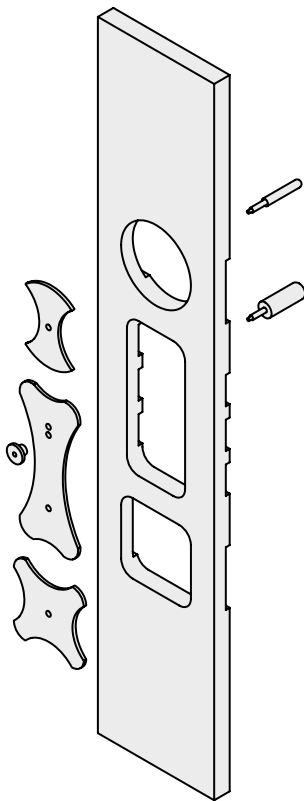

9c

Routing jigs and fixing equipment

Routing jig for flush-fitted roses

03 0462

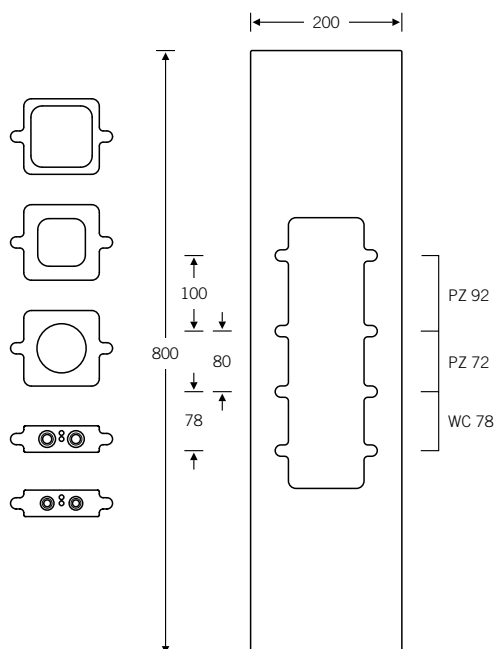

German centres

How to use for 17 1733 / 17 1734: push the two centring devices into the timber routing jig and place the assembly against the door. Slot the two guide pins on the centring devices into the handle follower and the profile cylinder or other keyway, and then align the routing jig parallel with the door leaf. Secure the routing jig to the door with C-clamps at the resulting position, then drill the holes for the roses and hardware respectively through the bushings on the centring devices. Now remove the centring devices and, using the small insert, mill out the recesses to a depth of 3 mm and a diameter of 55.6 mm with the aid of a $\varnothing 20$ mm routing bit and a $\varnothing 30$ mm collar ring. Then switch to the large insert and mill out the corner areas, likewise to a depth of 3 mm using a $\varnothing 30$ mm collar ring but only a $\varnothing 4$ mm routing bit. Repeat the process on the opposite side.

How to use for heavy-duty sets and 17 1736 / 17 1737: use the circular insert to mill out recesses to a depth of 3 or 7 mm with a $\varnothing 20$ mm routing bit and a $\varnothing 30$ mm collar ring.

03 0462 00030
(PC 72 + 92 mm, WC/T/8/78 mm)

For angular flush-fitted roses
17 1733 / 17 1734, door thicknesses of
38–42 mm, depth 3 mm, 55.6 × 55.6 mm

For round flush-fitted roses
17 1736 / 17 1737, door thicknesses of
38–42 mm, depth 3 mm, $\varnothing 55.6$ mm

For flush-fitted heavy-duty sets (round
roses) 72 and 76, 79, door thickness
45 mm upwards, depth 7 mm, $\varnothing 55.6$ mm

For flush-fitted security rose 73 7396

Routing jigs and fixing equipment

Routing jig for plug-in handles for timber windows for timber windows

03 0462

03 0462 00040 9600

Routing jig for
plug-in handles for timber windows,
lockable and not lockable

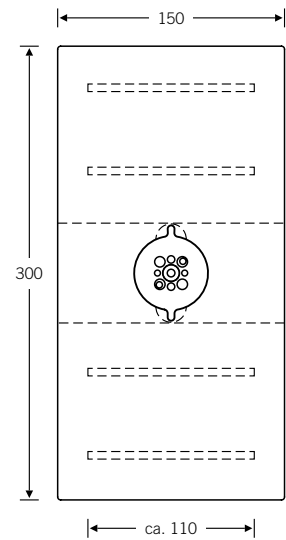
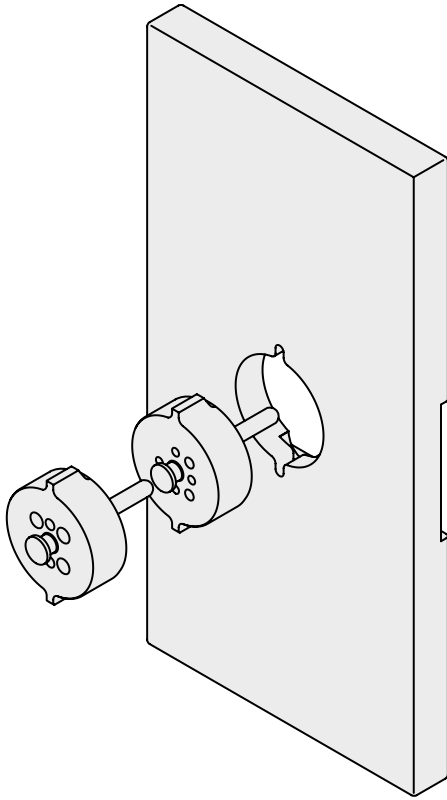

9c

Routing jigs and fixing equipment

Template for short backplates with concealed fixing

03 0477

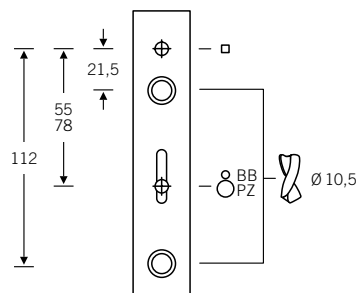

Fixing template for:

- FSB short backplate sets with FSB AGL® and FSB AGL® fire safety
- FSB short backplate sets with FSB ASL®

Variable use for
WL, PC, WC 55–78 mm

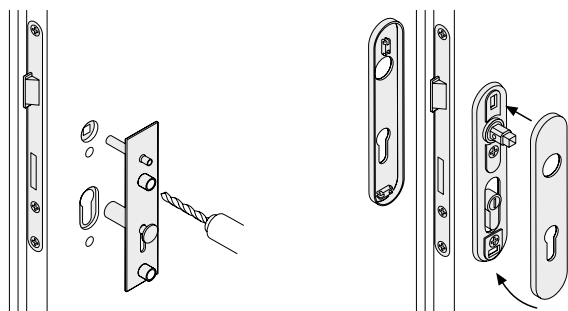

Paper template

78 8429 00253
for FSB short backplates with FSB ASL®
and FSB AGL® and FSB AGL® fire safety
heavy-duty fittings

Routing jigs and fixing equipment

Template for long and broad backplates with concealed fixing

03 0476

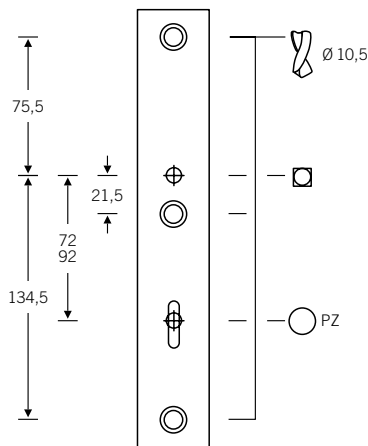

Fixing template for:

- FSB long backplate sets with FSB AGL® and FSB AGL® fire safety
- FSB long backplate sets with FSB ASL®
- FSB security fitting for narrow-stile doors FSB 73 7330 and 73 7331 FSB 73 7530 and 73 7531
- FSB narrow-stile door sets in long backplate variant FSB 06 7816

Variable use for
WL, PC, WC 72–92 mm

03 0478

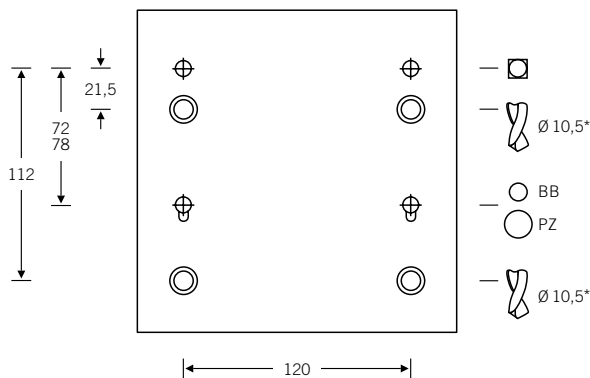

Fixing template for:

- FSB broad backplate sets with FSB AGL® FSB 72 WL, PC, WC 72–78 mm
- FSB broad backplate sets in FSB AGL® fire safety variant FSB 76 PC 72 mm

* Drill hole for stabiliser lugs
for FSB AGL® 72: 4 × 10.5 mm
for FSB AGL® FS 76: 2 × 10.5 mm
(through-drilling on lock side) or 2 × 3.5 mm (face-drilling outside lock area)

Note the door handing.
Adaptor for bushings (drill hole 3.5 mm) is included in the scope of delivery.

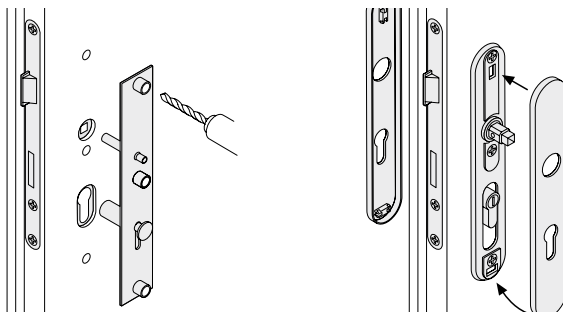

Paper templates

78 8429 00256 FSB AGL®
78 8429 00292 FSB AGL® FS
for FSB broad backplates

78 8429 00254
for FSB long backplates with FSB ASL®,
FSB AGL® and FSB AGL® fire safety
78 8429 00255 WC sets

9c

Routing jigs and fixing equipment

Template for narrow-stile door roses with rivet nuts

03 0481

Fixing template for oval FSB roses with rivet nuts and when using FSB fixing accessories 05 0526

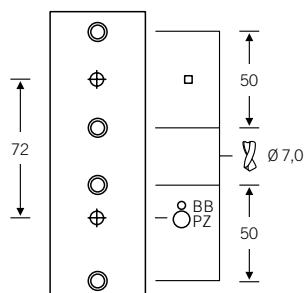

WL, PC 72 mm

03 0482

Fixing template for oval FSB roses with rivet nuts and when using FSB fixing accessories 05 0526

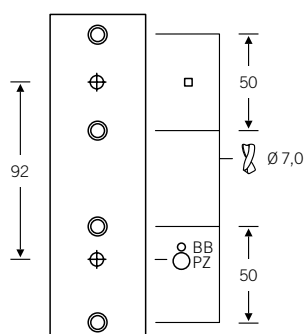

WL, PC 92 mm

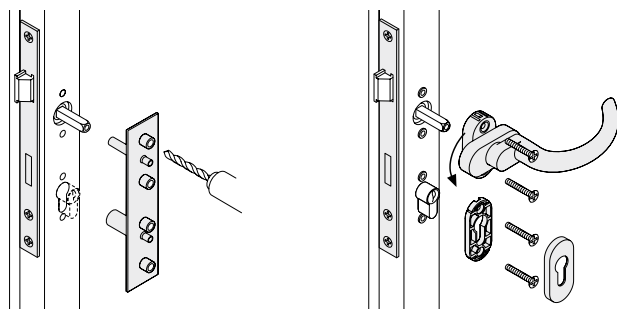

Paper template

78 8429 00259
for FSB narrow-stile door handles on oval rose with rivet nuts

Routing jigs and fixing equipment

Template for security fittings

03 0487

Fixing template for
FSB security set in long backplate variant

Variable use for PC 72–92 mm

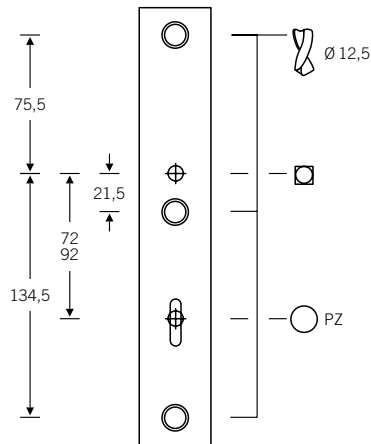

03 0488

Fixing template for
FSB security set in short backplate variant

PC 72 mm

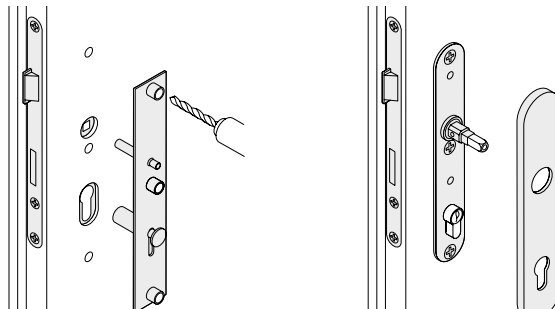
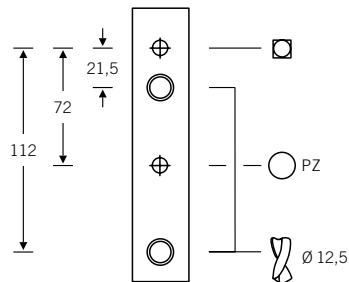

Paper templates

78 8429 00211 – 78 8429 00216
(depending on variant) for FSB security set

9c

- 790 FSB contact persons + locations
- 791 General index
- 794 Index of product groups
- 795 Product code index

Appendix

FSB contact persons + locations

Franz Schneider
Brakel GmbH + Co KG

Nieheimer Strasse 38
33034 Brakel
Germany

Tel. +49 (0)52 726 080
Fax +49 (0)52 7260 8300

www.fsb.de
info@fsb.de

FSB contact persons

To get comprehensive product advice or to order samples and tender specifications, please contact:

sales@fsb.de
Tel. +49 (0) 5272 608 116

Your local FSB contact person for personal consultations, as well as international FSB sales offices, can be found at:

www.fsb.de/contact

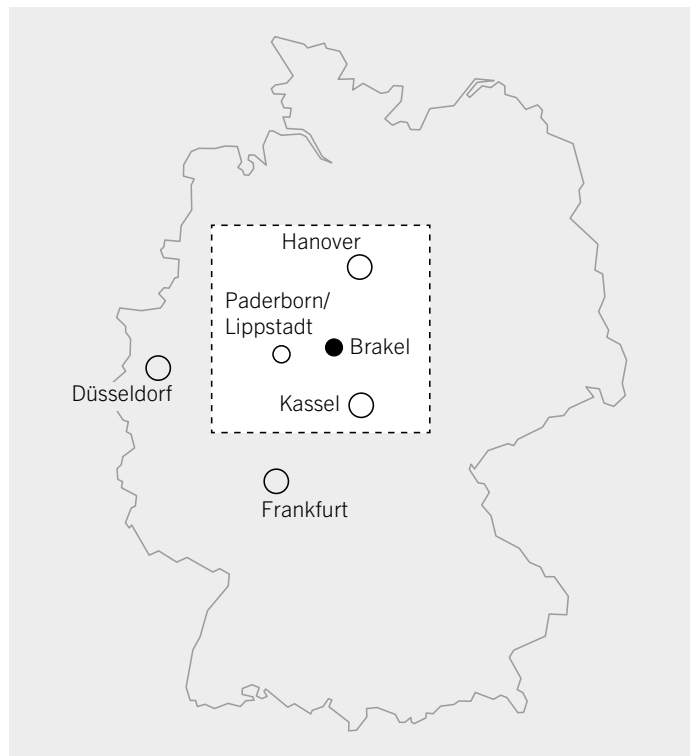

Brakel is located near Paderborn in the south-eastern tip of North Rhine-Westphalia in Germany. Paderborn is well connected to a number of national and international airports. An ICE high-speed rail station is located at Kassel-Wilhelmshöhe, just under an hour's drive from Brakel. Of Germany's key airports, the closest to Brakel are Hanover (approx. 120 km away),

Düsseldorf (approx. 200 km) and Frankfurt (approx. 220 km). To reach Brakel by car from the north: on the A2 between Hanover and Dortmund, take the Rinteln exit and then follow the B roads from Rinteln, through Barntrop and Blomberg, and finally to Brakel (approx. 90 km). To reach Brakel by car from the south: on the A44 between Kassel and Dortmund, take the

Warburg/Brakel exit and then follow the B252 from Warburg, through Peckelsheim, Siddessen and Rheder, and finally to Brakel (approx. 35 km). FSB has two locations in Brakel. The head office is at Nieheimer Strasse 38. The aluminium foundry, tool workshop, Development department and plants 2–5 are located together with the logistics centre at Industriestrasse 12.

Appendix

General index

| | |
|------------------------------------------------------------------|------------------------------------------------------|
| 0° position door handle | 53, 59 |
| Accessories | 756 ff. |
| Adaptor system | 52 f., 322 |
| Added value of door handles | 70 f. |
| Added value of door pulls with Fingerscan | 704 f. |
| Added value of fittings for emergency exit and panic doors | 590 f. |
| Added value of fittings for entrance doors | 628 f. |
| Added value of fittings for glass doors | 498 f. |
| Added value of fittings for narrow-stile doors | 464 f. |
| Added value of fittings for sliding doors | 544 f. |
| Added value of lever handles with privacy function | 528 f. |
| Added value of plug-in handles for doors | 396 f. |
| Added value of recessed lever handles | 578 f. |
| Added value of security fittings | 714 f. |
| Added value of window handles | 408 f. |
| Added value of XXL door handles | 614 f. |
| AIC, anti-infection coating | 12 f., 614, 621 |
| Aluminium | 14 ff., 44 ff. |
| Automatic locking | 411, 428 ff. |
| Backplates | 322, 358, 333, 386 |
| Ball catch | 410 ff., 454 |
| Barrier-free fitting | 6, 36 f. |
| Bearings / bearing technology | 52 ff. |
| Broad backplate | 70, 322, 360 |
| Bronze | 15 f., 24 f. |
| Budget lock roses | 438 |
| Care | 12, 614 f. |
| Certification | 6, 75 |
| Classification code | 62 f., 404, 454 f., 490 f. |
| Crossbar fittings | 590 ff. |
| Cut roses/backplates | 322, 362 |
| DIN 18257 | 715 f., 735, 744 f. |
| DIN EN 1627–1630 | 411, 744 |
| DIN handing | 75 |
| Door holder for glass doors | 519 |
| Door pulls | 628 ff. |
| Door pulls with Fingerscan | 704 ff. |
| Doorknobs | 339 ff., 375 ff. |
| Doorknobs for glass doors | 516 ff. |
| Doorknobs for narrow-stile doors | 479 ff., 82 ff. |
| Downloads | 9 |
| Durability rating 5/180 | 410 ff., 454 |
| Emergency release | 59, 316 |
| EN 1125 | 9, 590 ff., 610 |
| EN 13126-3 | 408 ff., 454 |
| EN 179 | 9, 72 ff., 578, 590 ff., 604 ff. |
| EN 1906 | 9, 53, 57 ff., 62 ff., 404, 490 ff., 714 ff., 744 f. |
| EPD, environmental product declaration | 6, 9 |
| ErgoSystem® A100 | 36 f., 44 ff. |
| ErgoSystem® E300 | 36 f., 38 ff. |
| Female knob handles | 346 f., 379 f. |
| Fingerscan | 704 ff. |
| Finishes | 14 ff. |
| Fire safety sets / fire safety fittings | 9, 64, 75 |
| Fixing door pulls | 691 ff. |
| Fixing equipment | 756 f., 774 ff. |
| Fixing system for narrow-stile doors | 493 ff. |
| Fixing system for plug-in handles for doors | 405 |
| Fixing system for plug-in handles for windows | 459 ff. |

Appendix

General index

| | |
|---------------------------------------------------|------------------------------|
| Flexible/dependable delivery | 9 |
| Flush ring handles | 586 f. |
| Flush-fitted hardware | 368 f., 536 ff. |
| Flush-fitted security rose | 741 |
| Flush-fitted window handles | 410, 458 |
| FSB AGL® | 53, 59 f., 62 f., 74 |
| FSB ASL® | 53, 56 f., 62 f., 74 |
| FSB ASL® accessory bag | 348 ff. |
| FSB Select | 72 |
| Glass door fitting | 498 ff. |
| Glass-door hinges | 513 ff. |
| Half-sets for entrance doors | 683 ff. |
| Handmade | 10 f. |
| Handrail | 12, 36 ff. |
| Heavy-duty fitting | 53 |
| Hospital | 12, 620 f. |
| Inactive-leaf sets | 84 ff., 468 |
| Individual parts | 52 ff., 322 ff. |
| Inside backplate for security fitting | 373 |
| ISO 14001 | 6 |
| ISO 50001 | 6 |
| Kit | 322 f. |
| Knob backplates | 337 f., 370 f. |
| Letter plates | 686 f. |
| Lever handles for emergency exit doors | 58 ff., 72 ff., 591, 604 ff. |
| Lever handles for narrow-stile doors | 82 ff., 606 ff., 464 ff. |
| Lever handles with privacy function | 528 ff. |
| Lever/knob set for narrow-stile doors | 735 f., 487 |
| Lever/knob sets | 52 ff., 80 ff., 536 |
| Lever/lever sets | 76 ff., 486, 536, 56, 735 f. |
| Lifting/sliding door fittings | 76 ff., 10 f., 442 ff. |
| Lockable window handle | 411, 428 |
| Lockable window-handle roses | 382 f. |
| Locks for narrow-stile doors | 495 |
| Made in Brakel | 6 |
| Materials | 14 ff. |
| METRIC® | 43 |
| Non-handed | 55 ff. |
| Nursing homes | 12 f. |
| Parallel slide/tilt fittings (PST) | 439 f. |
| Plant tours | 9 |
| Plug-in handle for doors | 81 ff., 396 ff. |
| Plug-in handle for windows | 81 ff., 412 ff. |
| Positive mechanism | 53, 56 ff., 465 f., 591 |
| Product configuration | 73, 322 ff. |
| Production expertise | 8 |
| Push/pull pad handles | 634 ff. |
| PVD | 23 |
| Quality standard RAL-GZ 607/9 | 411 |
| Recessed handles | 441, 449 |
| Recessed lever handles | 578 ff. |
| Reduction of pathogens | 12 |
| Renovation backplate | 361, 623 |
| Resistance class RC 1 to RC 6 | 411, 744 |
| Roses | 322 ff. |
| Roses for plug-in handles | 383, 372 |
| Routing dimensions for sliding door handles | 569 ff. |
| Routing jigs | 774 ff. |
| S-Flat push/pull pad handles | 636 |

| | |
|-----------------------------------------------------------------------------|---------------------------|
| Sanitary fit-out | 36 ff. |
| Screws | 769 ff. |
| Security fittings | 714 ff. |
| Security grades | 64, 744 f., 492 |
| Security roses | 537, 717, 737 ff. |
| Service | 9 |
| Sets for narrow-stile doors | 84 ff., 464 ff. |
| Slide-on and adhesive roses | 485 |
| Sliding door handles | 544 ff. |
| Sliding door handles for glass doors | 518 ff. |
| Smoke control set | 75, 486 f., 538, 618 f. |
| Special spindle for FSB AGL® FS EN 179 sets | 768 |
| Spindles | 756 ff., 494 |
| Stainless steel | 12 ff., 38 ff., 15, 22 f. |
| Sustainability | 6 |
| Technical information for bearing and adaptor technology | 61 ff. |
| Technical information for fittings for emergency exit and panic doors | 609 ff. |
| Technical information for fittings for entrance doors | 689 ff. |
| Technical information for fittings for glass doors | 521 ff. |
| Technical information for fittings for narrow-stile doors | 489 ff. |
| Technical information for fittings for sliding doors | 569 ff. |
| Technical information for fittings for windows | 453 ff. |
| Technical information for individual product configuration | 385 ff. |
| Technical information for security fittings | 743 ff. |
| Tee handles for windows | 422 ff. |
| Tilt-to-turn | 411, 428 f. |
| Turnably fixed | 52 ff. |
| Universal template | 775 |
| WC roses | 316, 390, 398, 539 |
| WC sets | 57 ff., 80 ff., 316, 536 |
| Window handle | 408 ff. |
| Window handles for specific requirements | 426 f. |
| Window securing device | 437 |
| Window-handle roses | 381 f., 432 |
| XXL door handles | 13, 614 ff. |

Appendix

Index of product groups

03 | Thumb turns, installation aids, drilling templates, spare parts

05 | Spindles, fixing material and accessories

06 | Cranked lever handles for narrow-stile doors

07 | Doorknobs for narrow-stile doors

08 | Female knob handles

09 | In-line lever handles for narrow-stile doors

10 | Female lever handles (without handle roses)

12 | FSB ASL® Architectural hardware

13 | Fittings for glass doors

14 | Lever handle backplates with visible fixing

15 | Plug-in handles for doors

17 | Roses

19 | Knob backplates

23 | Doorknobs on roses

24 | Door pulls with Fingerscan

34 | Fittings for windows

36 | Cabinet knobs

38 | Letter plates, door stops

42 | Sliding door handles, flush ring handles

61 | Push/pull pad handles

66 | Door pulls

70 | Fittings for entrance doors

72 | Heavy-duty sets with FSB AGL® bearing

73 | Security fittings

76 | Heavy-duty fire safety sets with FSB AGL® FS bearing

77 | Recessed lever handles, crossbar fittings

79 | Heavy-duty fire safety sets for emergency exit doors with FSB AGL® bearing conforming to EN 179

Appendix

Product code index

| Product code | Page | Product code | Page | Product code | Page | Product code | Page |
|--------------|---------------|--------------|---------------|--------------|----------|--------------|----------|
| 03 0401 | 383, 461 ff. | 05 0587 | 692, 697 | 07 0802 | 479 | 09 1178 | 192, 607 |
| 03 0410 | 771 | 06 0605 | 477 | 07 0804 | 479 | 09 1232 | 258, 607 |
| 03 0418 | 29, 482, 685 | 06 0620 | 478 | 07 0809 | 480 | 09 1243 | 268, 607 |
| 03 0450 | 771 | 06 0644 | 248 | 07 0812 | 480 | 09 1245 | 274, 607 |
| 03 0453 | 776 | 06 0662 | 476 | 07 0829 | 481 | 09 1247 | 280, 607 |
| 03 0455 | 777, 778 | 06 0663 | 478 | 07 0846 | 481 | 09 1255 | 290, 607 |
| 03 0457 | 779 | 06 1001 | 82 | 07 0854 | 482 | 09 1268 | 296, 607 |
| 03 0460 | 775 | 06 1002 | 82, 606 | 09 0001 | 366 | 09 1285 | 310 |
| 03 0462 | 780 ff. | 06 1015 | 104 | 09 1183 | 248 | 09 1286 | 308, 607 |
| 03 0476 | 785 | 06 1016 | 110, 156, 606 | 09 1001 | 82 | 10 1001 | 324 |
| 03 0477 | 784 | 06 1023 | 120 | 09 1002 | 82, 606 | 10 1003 | 324 |
| 03 0478 | 785 | 06 1031 | 126, 606 | 09 1004 | 92 | 10 1004 | 324 |
| 03 0481 | 786 | 06 1035 | 126 | 09 1005 | 98 | 10 1015 | 324 |
| 03 0482 | 786 | 06 1043 | 180, 606 | 09 1015 | 104 | 10 1016 | 324 |
| 03 0487 | 787 | 06 1045 | 132, 606 | 09 1016 | 110, 606 | 10 1021 | 324 |
| 03 0488 | 787 | 06 1053 | 120, 606 | 09 1023 | 120 | 10 1023 | 324 |
| 05 0115 | 765 | 06 1070 | 146, 606 | 09 1031 | 126, 606 | 10 1035 | 324 |
| 05 0116 | 765 | 06 1076 | 156 | 09 1035 | 126 | 10 1045 | 324 |
| 05 0117 | 759, 761, 763 | 06 1078 | 162 | 09 1043 | 180, 606 | 10 1051 | 324 |
| 05 0118 | 758, 760 | 06 1088 | 162, 606 | 09 1045 | 132, 606 | 10 1058 | 324 |
| 05 0122 | 762 | 06 1093 | 168 | 09 1053 | 120, 606 | 10 1070 | 324 |
| 05 0123 | 762 | 06 1094 | 168, 606 | 09 1070 | 146, 606 | 10 1075 | 324 |
| 05 0125 | 768 | 06 1107 | 186 | 09 1074 | 248, 606 | 10 1076 | 324 |
| 05 0188 | 764 | 06 1108 | 192 | 09 1076 | 156 | 10 1078 | 324 |
| 05 0189 | 764 | 06 1119 | 198, 606 | 09 1078 | 162 | 10 1093 | 324 |
| 05 0303 | 769 | 06 1134 | 92, 607 | 09 1087 | 477 | 10 1097 | 324 |
| 05 0308 | 769 | 06 1144 | 208 | 09 1088 | 162, 606 | 10 1102 | 324 |
| 05 0309 | 769 | 06 1146 | 214, 607 | 09 1093 | 162 | 10 1106 | 324 |
| 05 0313 | 770 | 06 1159 | 226, 607 | 09 1094 | 162, 606 | 10 1107 | 325 |
| 05 0315 | 770 | 06 1160 | 232, 607 | 09 1102 | 174, 606 | 10 1108 | 325 |
| 05 0316 | 770 | 06 1163 | 238 | 09 1106 | 180 | 10 1119 | 325 |
| 05 0319 | 771 | 06 1164 | 238, 607 | 09 1107 | 186 | 10 1135 | 325 |
| 05 0320 | 771 | 06 1177 | 186, 607 | 09 1108 | 192 | 10 1144 | 325 |
| 05 0325 | 771 | 06 1178 | 192, 607 | 09 1119 | 198, 606 | 10 1146 | 325 |
| 05 0425 | 771 | 06 1232 | 258, 607 | 09 1134 | 92, 607 | 10 1147 | 325 |
| 05 0525 | 766 | 06 1243 | 268, 607 | 09 1144 | 208 | 10 1159 | 325 |
| 05 0526 | 767 | 06 1245 | 274, 607 | 09 1146 | 214 | 10 1160 | 325 |
| 05 0565 | 348 ff. | 06 1247 | 280, 607 | 09 1147 | 220 | 10 1163 | 325 |
| 05 0566 | 348 ff. | 06 1255 | 290, 607 | 09 1150 | 476 | 10 1176 | 325 |
| 05 0567 | 348 ff. | 06 1268 | 296, 607 | 09 1159 | 226, 607 | 10 1183 | 325 |
| 05 0580 | 692, 694 ff. | 06 1272 | 302, 607 | 09 1160 | 232, 607 | 10 1226 | 325 |
| 05 0582 | 692, 693 | 06 1286 | 310 | 09 1163 | 238 | 10 1232 | 325 |
| 05 0583 | 692, 696 | 06 1286 | 302, 601 | 09 1164 | 238, 607 | 10 1241 | 325 |
| 05 0585 | 692, 699 | 06 7816 | 486 ff. | 09 1177 | 186, 607 | 10 1242 | 325 |

Appendix

Product code index

| Product code | Page | Product code | Page | Product code | Page | Product code | Page |
|---------------|---------|---------------|----------|---------------|----------|---------------|-------------------|
| 10 1244 | 325 | 12 1251 | 284 ff. | 15 1023 | 119 | 17 1759 | 438 |
| 10 1246 | 325 | 12 1254 | 288 ff. | 15 1035 | 125 | 17 1765 | 485 |
| 10 1251 | 325 | 12 1267 | 294 ff. | 15 1045 | 131 | 17 1766 | 485 |
| 10 1254 | 325 | 12 1271 | 300 ff. | 15 1051 | 137 | 17 1768 | 485 |
| 10 1267 | 325 | 12 1285 | 306 ff. | 15 1058 | 141 | 17 1769 | 485 |
| 10 1271 | 325 | 12 1410 | 336 | 15 1070 | 145 | 17 1778 | 363 |
| 10 1285 | 325 | 12 1418 | 334 | 15 1075 | 151 | 17 1786 | 438 |
| 12 1001 | 80 ff. | 12 1450 | 335 | 15 1076 | 155 | 17 1788 | 367 |
| 12 1002 | 80 ff. | 12 1451 | 333 | 15 1078 | 161 | 17 1790 | 362 |
| 12 1003 | 86 ff. | 12 1703 | 331, 333 | 15 1093 | 167 | 17 1791 | 362 |
| 12 1004 | 90 ff. | 12 1704 | 331 | 15 1102 | 173 | 17 1795 | 362 |
| 12 1005 | 96 ff. | 12 1731 | 330, 332 | 15 1106 | 179 | 17 1796 | 362 |
| 12 1015 | 102 ff. | 12 1735 | 330 | 15 1107 | 185 | 19 1923 | 370 |
| 12 1016 | 108 ff. | 12 1799 | 332 ff. | 15 1108 | 191 | 19 1927 | 337, 370 |
| 12 1021 | 114 ff. | 13 4257 | 519 | 15 1119 | 197 | 19 1963 | 338 |
| 12 1023 | 118 ff. | 13 4220 | 506 ff. | 15 1135 | 203 | 19 1964 | 337 |
| 12 1035 | 124 ff. | 13 4230 | 519 | 15 1144 | 207 | 19 1966 | 371 |
| 12 1045 | 130 ff. | 13 4223 | 509 ff. | 15 1146 | 213 | 19 1970 | 338, 371 |
| 12 1051 | 136 ff. | 13 4224 | 504 ff. | 15 1147 | 219 | 23 0802 | 339, 375, 516 |
| 12 1058 | 140 ff. | 13 4227 | 515 | 15 1159 | 225 | 23 0803 | 339, 375 |
| 12 1070 | 144 ff. | 13 4228 | 514 | 15 1160 | 231 | 23 0804 | 340, 376 |
| 12 1075 | 150 ff. | 13 4231 | 511 ff. | 15 1176 | 243 | 23 0809 | 340 |
| 12 1076 | 156 ff. | 13 4232 | 513 | 15 1183 | 247 | 23 0811 | 341, 376 |
| 12 1078 | 160 ff. | 13 4256 | 518 | 15 1226 | 253 | 23 0812 | 341 |
| 12 1093 | 166 ff. | 14 1402 | 359 | 15 1232 | 257 | 23 0828 | 342, 377, 517 |
| 12 1102 | 172 ff. | 14 1410 | 359 | 15 1242 | 267 | 23 0829 | 342, 377, 517 |
| 12 1106 | 178 ff. | 14 1415 | 358 | 15 1244 | 273 | 23 0844 | 343, 378, 516 |
| 12 1107 | 184 ff. | 14 1418 | 358 | 15 1246 | 279 | 23 0846 | 343 |
| 12 1108 | 190 ff. | 14 1425 | 363 | 15 1254 | 289 | 23 0854 | 344 |
| 12 1119 | 196 ff. | 14 1433 | 361 | 15 1267 | 295 | 23 0873 | 344 |
| 12 1144 | 206 ff. | 14 1458 | 364 ff. | 15 1271 | 301 | 23 0880 | 345, 378 |
| 12 1146 | 212 ff. | 14 1459 | 364 ff. | 15 1285 | 307 | 24 6531 | 708 |
| 12 1147 | 218 ff. | 14 1486 | 360 | 15 1720 | 372 | 24 6582 | 710 |
| 12 1159 | 224 ff. | 14 1550 | 366 | 15 1721 | 372 | 24 6607 | 706 |
| 12 1160 | 230 ff. | 14 1596 | 366 | 17 1729 | 485 | 34 0000 | 381 ff. |
| 12 1163 | 236 ff. | 14 4240 | 324 | 17 1730 | 485 | 34 1001 | 81 |
| 12 1176 | 242 ff. | 14 4241 | 324 | 17 1733 | 369, 536 | 34 1003 | 87 |
| 12 1183 | 246 ff. | 15 1001 | 81 | 17 1734 | 369, 536 | 34 1004 | 91 |
| 12 1226 | 252 ff. | 15 1003 | 87 | 17 1736 | 368, 536 | 34 1005 | 97 |
| 12 1232 | 256 ff. | 15 1004 | 91 | 17 1737 | 368, 536 | 34 1015 | 103 |
| 12 1241 | 262 ff. | 15 1005 | 97 | 17 1752 | 367 | 34 1016 | 109 ff., 439, 443 |
| 12 1242 | 266 ff. | 15 1015 | 103 | 17 1755 | 367 | 34 1021 | 115 |
| 12 1244 | 272 ff. | 15 1016 | 109 | 17 1757 | 367 | 34 1023 | 119 |
| 12 1246 | 278 ff. | 15 1021 | 115 | 17 1758 | 367 | 34 1035 | 125 |

| Product code | Page | Product code | Page | Product code | Page | Product code | Page |
|---------------|-------------------|---------------|--------------|---------------|------|---------------|----------|
| 34 1058 | 141 | 34 3488 | 433 | 61 6188 | 636 | 66 6653 | 668 |
| 34 1070 | 145 | 34 3491 | 435 | 61 6254 | 636 | 66 6655 | 668 |
| 34 1075 | 151 | 34 3495 | 435 | 66 6506 | 657 | 66 6659 | 673 |
| 34 1076 | 155 ff., 349, 354 | 34 3496 | 434 | 66 6507 | 657 | 66 6661 | 669 |
| 34 1078 | 161 | 34 3499 | 424, 426 ff. | 66 6514 | 658 | 66 6662 | 669 |
| 34 1093 | 167 | 34 3784 | 425 | 66 6615 | 659 | 66 6669 | 670 |
| 34 1102 | 173 | 36 3692 | 312 | 66 6519 | 638 | 66 6670 | 656 |
| 34 1106 | 179 | 36 3693 | 312 | 66 6520 | 638 | 66 6673 | 673 |
| 34 1107 | 185 | 36 3694 | 312 | 66 6522 | 676 | 66 6674 | 671 |
| 34 1108 | 191 | 38 3826 | 686 ff. | 66 6523 | 676 | 66 6675 | 651 |
| 34 1135 | 203 | 38 3829 | 687 | 66 6524 | 652 | 66 6681 | 674 |
| 34 1144 | 207 | 38 3816 | 752 | 66 6526 | 660 | 66 6683 | 673 |
| 34 1146 | 213 | 38 3878 | 752 | 66 6527 | 643 | 66 6715 | 678 |
| 34 1147 | 219 | 38 3880 | 753 | 66 6531 | 665 | 66 6716 | 678 |
| 34 1159 | 225 | 38 3881 | 752 | 66 6532 | 665 | 66 6717 | 678 |
| 34 1160 | 231 | 38 3884 | 752 | 66 6533 | 644 | 66 6718 | 678 |
| 34 1163 | 237 ff., 445 | 38 3888 | 752 | 66 6535 | 644 | 66 6719 | 679 |
| 34 1176 | 243 | 38 3895 | 753 | 66 6536 | 645 | 66 6735 | 654 |
| 34 1183 | 247 | 38 3898 | 313 | 66 6537 | 645 | 66 6736 | 654 |
| 34 1226 | 253 | 38 4006 | 313 | 66 6538 | 646 | 66 6737 | 654 |
| 34 1232 | 257 | 42 4203 | 586 | 66 6540 | 642 | 66 6738 | 654 |
| 34 1241 | 263 | 42 4204 | 586 | 66 6541 | 662 | 66 6739 | 655 |
| 34 1242 | 267 ff., 448 | 42 4205 | 587 | 66 6542 | 647 | 66 6801 | 655, 677 |
| 34 1244 | 273 | 42 4211 | 562 | 66 6546 | 663 | 66 6802 | 653 |
| 34 1246 | 279 | 42 4212 | 562 | 66 6548 | 640 | 70 1003 | 683 |
| 34 1251 | 285 | 42 4215 | 441, 449 | 66 6550 | 680 | 70 1004 | 683 |
| 34 1254 | 289 | 42 4217 | 450 | 66 6551 | 681 | 70 1005 | 683 |
| 34 1267 | 295 | 42 4250 | 550 | 66 6552 | 682 | 70 1015 | 683 |
| 34 1271 | 301 | 42 4251 | 551 | 66 6580 | 675 | 70 1023 | 683 |
| 34 1285 | 307 | 42 4252 | 552 | 66 6582 | 675 | 70 1035 | 683 |
| 34 3401 | 422 | 42 4253 | 553 | 66 6583 | 675 | 70 1070 | 684 |
| 34 3402 | 422, 438 | 42 4254 | 552 | 66 6602 | 656 | 70 1076 | 684 |
| 34 3403 | 424 | 42 4255 | 554 ff. | 66 6612 | 648 | 70 1102 | 684 |
| 34 3404 | 422 | 42 4260 | 563 | 66 6615 | 659 | 70 1107 | 684 |
| 34 3407 | 437 | 42 4261 | 563 | 66 6616 | 649 | 70 1108 | 684 |
| 34 3416 | 437 | 42 4262 | 564 | 66 6623 | 672 | 70 1146 | 684 |
| 34 3453 | 237, 424 | 42 4263 | 564 | 66 6628 | 637 | 70 1147 | 685 |
| 34 3454 | 425 | 42 4264 | 565 | 66 6629 | 637 | 70 1163 | 685 |
| 34 3455 | 425 | 42 4265 | 565 | 66 6630 | 664 | 70 1183 | 685 |
| 34 3460 | 432 | 61 6108 | 634 | 66 6635 | 650 | 72 1001 | 80 ff. |
| 34 3464 | 59, 316, 538 | 61 6181 | 634 | 66 6642 | 666 | 72 1004 | 90 ff. |
| 34 3471 | 432 | 61 6184 | 635 | 66 6643 | 666 | 72 1015 | 102 ff. |
| 34 3480 | 423 | 61 6186 | 636 | 66 6650 | 650 | 72 1016 | 108 ff. |
| 34 3481 | 433 | 61 6187 | 636 | 66 6652 | 651 | 72 1023 | 118 ff. |

Appendix

Product code index

| Product code | Page | Product code | Page | Product code | Page |
|---------------|----------|---------------|---------|---------------|-------------------|
| 72 1035 | 124 ff. | 73 7384 | 732 | 77 7981 | 597 ff. |
| 72 1045 | 130 ff. | 73 7385 | 733 | 77 7970 | 600 ff. |
| 72 1070 | 144 ff. | 73 7386 | 734 | 77 7971 | 603 |
| 72 1076 | 154 ff. | 73 7391 | 738 | 77 7972 | 603 |
| 72 1078 | 160 ff. | 73 7392 | 738 | 77 7973 | 603 |
| 72 1093 | 166 ff. | 73 7393 | 738 | 79 1002 | 80 ff., 604 |
| 72 1102 | 172 ff. | 73 7395 | 739 | 79 1016 | 108 ff., 604 |
| 72 1106 | 178 ff. | 73 7396 | 741 | 79 1031 | 124 ff., 604 |
| 72 1107 | 184 ff. | 73 7397 | 740 | 79 1043 | 178 ff., 604 |
| 72 1108 | 190 ff. | 73 7530 | 735 | 79 1045 | 75, 130 ff., 604 |
| 72 1119 | 196 ff. | 73 7531 | 736 | 79 1053 | 75, 118 ff., 604 |
| 72 1144 | 206 ff. | 73 7560 | 720 | 79 1070 | 75, 144 ff., 604 |
| 72 1146 | 212 ff. | 76 1001 | 80 ff. | 79 1074 | 246 ff., 604 |
| 72 1147 | 218 ff. | 76 1004 | 90 ff. | 79 1088 | 160 ff., 604 |
| 72 1159 | 226 ff. | 76 1015 | 102 ff. | 79 1090 | 618 |
| 72 1160 | 230 ff. | 76 1016 | 108 ff. | 79 1117 | 75, 618 |
| 72 1163 | 236 ff. | 76 1023 | 118 ff. | 79 1118 | 619 |
| 72 1183 | 246 ff. | 76 1035 | 124 ff. | 79 1119 | 196 ff., 604, 619 |
| 72 1226 | 252 ff. | 76 1076 | 154 ff. | 79 1134 | 90 ff., 605 |
| 72 1232 | 256 ff. | 76 1078 | 160 ff. | 79 1146 | 212 ff., 605 |
| 72 1242 | 266 ff. | 76 1093 | 166 ff. | 79 1155 | 13, 620 |
| 72 1244 | 272 ff. | 76 1102 | 172 ff. | 79 1160 | 230 ff., 605 |
| 72 1246 | 278 ff. | 76 1106 | 178 ff. | 79 1164 | 236 ff., 605 |
| 72 1254 | 288 ff. | 76 1107 | 184 ff. | 79 1177 | 184 ff., 605 |
| 72 1267 | 294 ff. | 76 1108 | 190 ff. | 79 1178 | 190 ff., 605 |
| 72 1271 | 300 ff. | 76 1144 | 206 ff. | 79 1232 | 256 ff., 605 |
| 72 1285 | 306 ff. | 76 1147 | 218 ff. | 79 1243 | 266 ff., 605 |
| 73 3244 | 737 | 76 1159 | 226 ff. | 79 1245 | 272 ff., 605 |
| 73 3249 | 737 | 76 1163 | 236 ff. | 79 1255 | 288 ff., 605 |
| 73 3533 | 373 | 76 1183 | 246 ff. | 79 1268 | 294 ff., 605 |
| 73 7330 | 735 | 76 1226 | 252 ff. | 79 1272 | 300 ff., 605 |
| 73 7331 | 736 | 76 1242 | 266 ff. | 79 1278 | 252 ff., 605 |
| 73 7360 | 720 | 76 1244 | 272 ff. | 79 1286 | 306 ff., 605 |
| 73 7372 | 374, 721 | 76 1254 | 288 ff. | 79 1287 | 13, 621 |
| 73 7373 | 722 | 76 1267 | 294 ff. | | |
| 73 7374 | 723 | 76 1271 | 300 ff. | | |
| 73 7375 | 724 | 76 1285 | 306 ff. | | |
| 73 7376 | 725 | 77 7947 | 582 | | |
| 73 7377 | 726 | 77 7948 | 583 | | |
| 73 7378 | 727 | 77 7949 | 584 | | |
| 73 7379 | 728 | 77 7950 | 585 | | |
| 73 7381 | 729 | 77 7952 | 585 | | |
| 73 7382 | 730 | 77 7954 | 585 | | |
| 73 7383 | 731 | 77 7980 | 592 ff. | | |



Franz Schneider
Brakel GmbH + Co KG

Nieheimer Strasse 38
33034 Brakel
Germany

Phone +49 5272 608-0
www.fsb.de · info@fsb.de